



BARRET®

ATTREZZATURE PER L'ALLENAMENTO DEI CAMPIONI
TRAINING TOOLS FOR CHAMPIONS



catalogo
2025-2026
brochure

GET READY FOR THE MATCH!



 **FORNITORE UFFICIALE**



Centro Sportivo Silvio e Luigi Berlusconi - Monzello



 **FORNITORE UFFICIALE**



Centro Sportivo Silvio e Luigi Berlusconi - Monzello



FORNI UFFICIALE



Centro Sportivo Silvio e Luigi Berlusconi - Monzello



 **FORNITORE UFFICIALE**



Centro Sportivo Silvio e Luigi Berlusconi - Monzello

Barret Srl

Dal 1989 Barret Srl produce attrezzature tecniche per lo sport.

In particolare, l'Azienda si è affermata nel corso degli anni per la ideazione e realizzazione di strumenti di allenamento ormai divenuti indispensabili per la preparazione fisica, tecnica e tattica dei giocatori di calcio, così come per la preparazione degli atleti di molti altri sport, sia di squadra che individuali.

Barret offre la più ampia varietà di attrezzature quali sagome, ostacoli, delimitatori, birilli, paletti per slalom, archi di precisione, kit per calcio-tennis, forche, bande elastiche, slitte, plinti, tavolette propriocettive, telai con rete, muri in vetroresina, porte minicalcio, porte bifrontali, ridotte e regolamentari.

La qualità che contraddistingue i prodotti offerti e le numerose innovazioni proposte con continuità nel corso degli anni hanno permesso all'Azienda di affermarsi non solo sul mercato italiano, ma anche su quello internazionale.

Barret ha sviluppato nel tempo una preziosa collaborazione con Juventus FC, AC Milan e FC Internazionale fondamentale per permettere un interscambio di idee ed informazioni con i preparatori atletici della prima squadra e del settore giovanile, finalizzato al continuo miglioramento della funzionalità delle attrezzature tecniche per l'allenamento.

I prodotti Barret, infatti, vengono utilizzati quotidianamente sui campi di allenamento de La Continassa, di Milanello e di Appiano Gentile per coadiuvare la preparazione fisica e tecnica di alcuni tra i migliori giocatori di calcio del mondo.

Sarebbe impresa ardua ricordare tutti i Club nazionali ed internazionali e le Federazioni che hanno scelto più volte di acquistare le nostre attrezzature attraverso la rete distributiva italiana ed estera.

Cogliamo l'occasione per ringraziare i preparatori atletici ed i responsabili acquisti di Milan, Inter, Juventus, Roma, Lazio, Napoli, Sampdoria, Fiorentina, Udinese, Palermo, Torino, Empoli, Cagliari, Bologna, Sassuolo, Spal, Barcellona, Real Madrid, Bayern Monaco, PSG, Arsenal, Chelsea, Manchester City, Zenit e delle Nazionali di Calcio di Italia, Germania, Inghilterra, Francia, Spagna, Portogallo e Russia.

Company Profile

Founded in 1989, Barret Srl gained a foothold in the international football training equipment market by creating innovative tools which have become more and more essential during training sessions of pro athletes worldwide.

Barret manufactures products such as mannequins, hurdles, markers, cones, slalom poles, shooting arcs, soccer-tennis kits, heading trellises, all kinds of fiberglass and net rebounders, sledges, vaulting boxes, equilibrium boards, any size goals and mini goals.

The quality and variety of products introduced over the years make Barret the go-to company when a training camp is about to start.

Barret has a long history of working together with Juventus FC, AC Milan and FC Internazionale, three of the most prestigious clubs in football history: all the inputs and feedbacks received by their coaches always pushes Barret to shape and improve new products.

As a matter of fact Barret tools are used everyday at La Continassa, Milanello and Appiano Gentile Training Centers in order to constantly enhance some of the best world football players' athletic and technical performances.

It would be nearly impossible to name all professional Football Clubs and National Teams that have chosen to purchase Barret products through our distribution network.

However we would like to take this opportunity to thank clubs such as Milan, Inter, Juventus, Roma, Lazio, Napoli, Sampdoria, Fiorentina, Udinese, Palermo, Torino, Empoli, Cagliari, Bologna, Sassuolo, Spal, Barcellona, Real Madrid, Bayern Monaco, PSG, Arsenal, Chelsea, Manchester City, Zenit and the Italian, English, German, Spanish, Portuguese, French and Russian National Teams.

BARRET®

Le materie prime (i vari preparati plastici ed i profilati in polipropilene copolimero ed in PVC nei vari diametri, spessori e colori) utilizzate da BARRET per lo stampaggio e l'assemblaggio degli articoli in materiale plastico sono certificate dai nostri fornitori nel rispetto delle normative vigenti che impediscono l'utilizzo di sostanze ritenute tossiche per la salute dell'uomo e dell'ambiente.

Barret manufactures plastic products in PVC and polypropylene such as dummies, cones, markers, hurdles, slalom poles etc. using only certified non toxic raw materials not dangerous for human beings and the environment.



BARRET srl
dal 1989
since 1989



BARRET
Attrezzature per l'allenamento dei campioni
Training Tools for champions

BARRET s.r.l.
Via Monte Carlo, 6/8
Zona Ind. S. Pietro in Palazzi
37023 CICERGA (VI) Italy
Telefono (+39) 0544.641213
Fax (+39) 0544.641217
E-mail: info@barrept.com
www.barrept.com

BARRET
ATTREZZATURE PER L'ALLENAMENTO DEI CAMPIONI
TRAINING TOOLS FOR CHAMPIONS

F.C. INTERNAZIONALE
APPIANO GENTILE

BARRET s.r.l.
Via Monte Carlo, 6/8
Zona Ind. S. Pietro in Palazzi
37023 CICERGA (VI) Italy
Telefono (+39) 0544.641213
Fax (+39) 0544.641217
E-mail: info@barrept.com
www.barrept.com

BARRET
ATTREZZATURE PER L'ALLENAMENTO DEI CAMPIONI
TRAINING TOOLS FOR CHAMPIONS

F.C. INTERNAZIONALE
CAMPO DI ALLENAMENTO APPIANO GENTILE
F.C. INTERNAZIONALE TRAINING CENTRE

BARRET s.r.l.
Via Monte Carlo, 6/8
Zona Ind. S. Pietro in Palazzi
37023 CICERGA (VI) Italy
Telefono (+39) 0544.641213
Fax (+39) 0544.641217
E-mail: info@barrept.com
www.barrept.com

Catálogo 2009-2010
2009-2010 Brochure

BARRET
ATTREZZATURE PER L'ALLENAMENTO DEI CAMPIONI
TRAINING TOOLS FOR CHAMPIONS

In ogni attività la posizione migliore è quella della difficoltà

F.C. Internazionale
Centro sportivo Angelo Moratti
Appiano Gentile

A.C. Milan
Centro Sportivo Milanello

BARRET s.r.l.
Via Monte Carlo, 6/8
Zona Ind. S. Pietro in Palazzi
37023 CICERGA (VI) Italy
Telefono (+39) 0544.641213
Fax (+39) 0544.641217
E-mail: info@barrept.com
www.barrept.com

Catálogo 2010-2011
2010-2011 Brochure

BARRET
ATTREZZATURE PER L'ALLENAMENTO DEI CAMPIONI
TRAINING TOOLS FOR CHAMPIONS

BARRET s.r.l.
Via Monte Carlo, 6/8
Zona Ind. S. Pietro in Palazzi
37023 CICERGA (VI) Italy
Telefono (+39) 0544.641213
Fax (+39) 0544.641217
E-mail: info@barrept.com
www.barrept.com

Catálogo 2013-2014
2013-2014 Brochure

BARRET
ATTREZZATURE PER L'ALLENAMENTO DEI CAMPIONI
TRAINING TOOLS FOR CHAMPIONS

BARRET s.r.l.
Via Monte Carlo, 6/8
Zona Ind. S. Pietro in Palazzi
37023 CICERGA (VI) Italy
Telefono (+39) 0544.641213
Fax (+39) 0544.641217
E-mail: info@barrept.com
www.barrept.com

BARRET
ATTREZZATURE PER L'ALLENAMENTO DEI CAMPIONI
TRAINING TOOLS FOR CHAMPIONS





FC. INTERNAZIONALE
CAMPO DI ALLENAMENTO APPIANO GENTILE
F.C. INTERNAZIONALE TRAINING CENTER



BARRET s.r.l.
Via Maria Curie, 6/8
37023 Zane (VI) - P.leo in Palazzo
CICHA 03 - Italy
Telefono: 0286.661215
Fax: 0286.662417
E-mail: info@barretsport.com
www.barretsport.com

BARRET
ATTREZZATURE PER L'ALLENAMENTO DEI CAMPIONI
TRAINING TOOLS FOR CHAMPIONS







Juventus Football Club - Torino
centro di allenamento
Training Center



BARRET s.r.l.
Via Maria Curie, 6/8
37023 Zane (VI) - P.leo in Palazzo
CICHA 03 - Italy
Telefono: 0286.661215
Fax: 0286.662417
E-mail: info@barretsport.com
www.barretsport.com

BARRET
ATTREZZATURE PER L'ALLENAMENTO DEI CAMPIONI
TRAINING TOOLS FOR CHAMPIONS

BARRET s.r.l.
Via Maria Curie, 6/8
37023 Zane (VI) - P.leo in Palazzo
CICHA 03 - Italy
Telefono: 0286.661215
Fax: 0286.662417
E-mail: info@barretsport.com
www.barretsport.com



Juventus Training Center - Vinova (TO)

BARRET
ATTREZZATURE PER L'ALLENAMENTO DEI CAMPIONI
TRAINING TOOLS FOR CHAMPIONS



BARRET s.r.l.
Via Maria Curie, 6/8
37023 Zane (VI) - P.leo in Palazzo
CICHA 03 - Italy
Telefono: 0286.661215
Fax: 0286.662417
E-mail: info@barretsport.com
www.barretsport.com

BARRET
ATTREZZATURE PER L'ALLENAMENTO DEI CAMPIONI
TRAINING TOOLS FOR CHAMPIONS

BARRET s.r.l.
Via Maria Curie, 6/8
37023 Zane (VI) - P.leo in Palazzo
CICHA 03 - Italy
Telefono: 0286.661215
Fax: 0286.662417
E-mail: info@barretsport.com
www.barretsport.com

BARRET
ATTREZZATURE PER L'ALLENAMENTO DEI CAMPIONI
TRAINING TOOLS FOR CHAMPIONS



BARRET s.r.l.
Via Maria Curie, 6/8
37023 Zane (VI) - P.leo in Palazzo
CICHA 03 - Italy
Telefono: 0286.661215
Fax: 0286.662417
E-mail: info@barretsport.com
www.barretsport.com

BARRET srl
dal 1989
since 1989

NUOVI PRODOTTI - NEW PRODUCTS



CON STRUTTURA
POSTERIORE PIEGHEVOLE
WITH FOLDABLE REAR STRUCTURE

Art. ML1208

PORTE MINICALCIO m. 1,2 x 0,8 in alluminio tubo sezione mm.80, complete di reti
Pair of aluminium mini football goals 1,2 x 0,8 m. nets and pegs included

pag. 146



Art. ML151

PORTE MINICALCIO m. 1,5 x 1 in alluminio tubo sezione mm.80, complete di reti
Pair of aluminium mini football goals 1,5 x 1 m. nets and pegs included

pag. 146

CON STRUTTURA
POSTERIORE PIEGHEVOLE
WITH FOLDABLE REAR STRUCTURE

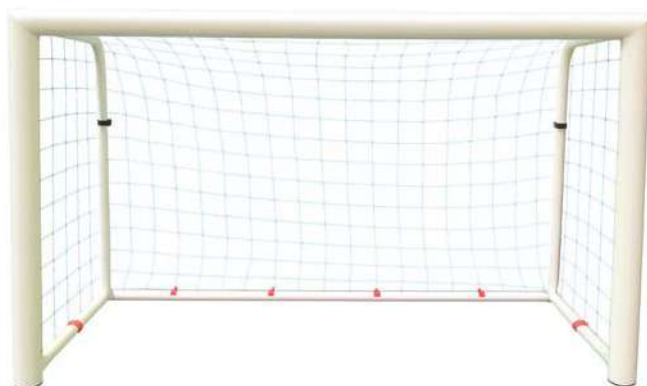

Art. ML1812

PORTE MINICALCIO m. 1,8 x 1,2 in alluminio tubo sezione mm.80, complete di reti
Pair of aluminium mini football goals 1,8 x 1,2 m. nets and pegs included

pag. 146



pag. 58



Art. RBA75

**Telaio con rete bifacciale dim. cm.75x75
in ferro verniciato ad inclinazione regolabile - peso kg.5,3**
Double side painted iron frame with net size 75x75 cm.
adjustable inclination - 5,3 kg.



Art. TRXM

**TRX® MOVE - suspension trainer della gamma TRX® ottimo
per gli allenamenti di tutti i livelli. Costruito con materiale
resistente e con moschettone testato per più di 320 Kg, aiuta
a bruciare i grassi e a migliorare la forza muscolare**
Suspension trainer from the TRX® range excellent for training of
all levels. Built with resistant material and with a carabiner tested
for more than 320 kg, it helps burn fat and improve
muscle strength



Art. MAT160
Materassino arrotolabile blu
cm. 160x50x0,8 con maniglia
per il trasporto
Rolled foam Mat
160x50x0,8 cm. with handle
for transport

pag. 109



Art. TE52030

Spazzolone cm. 200
per campi in erba sintetica
con 4 spazzole da cm. 50,
contrappesi laterali antivibrazione,
manico in alluminio, setole in plastica dura,
larghezza cm. 10
200 cm. Brush
for synthetic grass fields
with 4 brushes 50 cm.
anti-vibration lateral counterweights,
aluminum handle, hard plastic bristles,
width 10 cm.

pag. 164



pg.1

**NUOVO MATERIALE PIÙ FLESSIBILE
NEW MORE ELASTIC PLASTIC MATERIAL**



Art. 001
Sagoma Barret brevettata
cm. 180 Kg. 3,5
Patented Barret Mannequin
cm. 180 Kg. 3,5

Art. 002
Sagoma Barret brevettata
cm. 160 Kg. 3
Patented Barret Mannequin
cm. 160 Kg. 3

Colori:
Rosso, Blu e Giallo
Colors:
Red, Blue and Yellow

SAGOME BARRET BREVETTATE
leggere, flessibili, super-resistenti,
antinfortunistiche!

PATENTED BARRET MANNEQUINS
light, flexible, strong, safe!

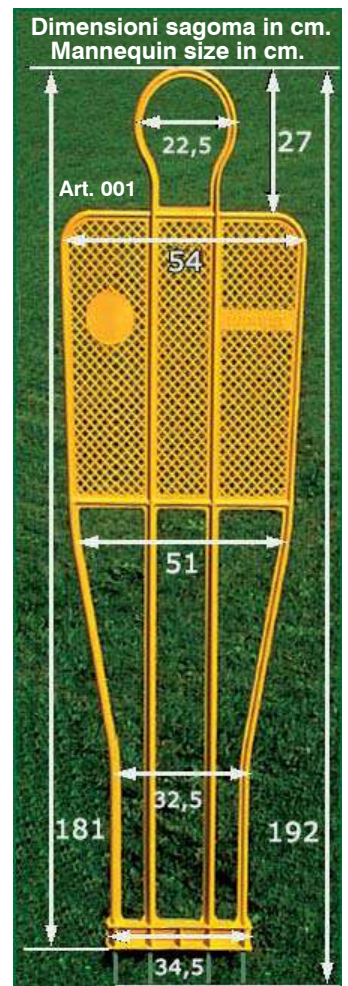

SAGOME E BARRIERE - Barriers



Art. 003 Carrello porta 5 sagome in acciaio zincato con ruote
Trolley for carrying 5 mannequins in galvanized steel, with wheels

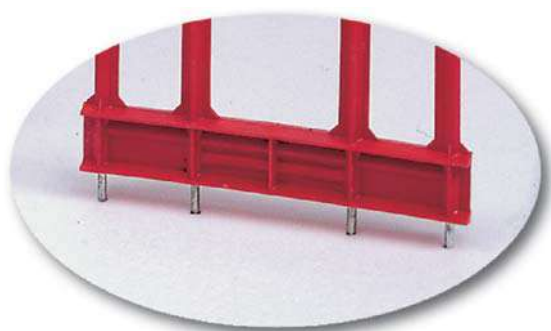

pg.1

**4 puntali in acciaio zincato alla base
per posizionamento su
terreno naturale
o su carrello porta sagome**
4 galvanized steel spikes at the base,
for easy positioning on natural grass
or upon Barret trolley



3 x Art. 001 + 2 x Art. 002 + Art. 003



Art. NCP3S
Carrello porta 3 sagome in acciaio zincato con ruote
Trolley for carrying 3 mannequins in galvanized steel, with wheels



3 x Art. 001 + Art. NCP3S

Video dimostrativo disponibile su www.barretsport.com
Video available on www.barretsport.com

pg.1



Il carrello regolabile in altezza permette di simulare la presenza di giocatori in barriera che saltano al momento del calcio di punizione

This trolley allows free kick practicing by simulating jumping defenders

3 x Art. 001 + 2 x Art. 002 + Art. 003RG

Art. 003RG

Carrello porta 5 sagome in acciaio zincato con ruote - regolabile a 4 altezze (la sagoma Art. 001 può arrivare ad un'altezza massima da terra di cm.225)
Trolley for carrying 5 mannequins in galvanized steel, with wheels - 4 adjustable heights (Art. 001 can reach up to 225 cm. height)



Art. 001R
 Rivestimento per
 sagoma cm. 180
 in nylon impermeabile
 antistrappo con cerniera
Colori: rosso, blu, giallo
 Nylon Cover for cm. 180
 mannequin with zip
 Colors: red, blue, yellow

Art. 002R
 Rivestimento per sagoma
 cm. 160 in nylon impermeabile
 antistrappo con cerniera
Colori: rosso, blu, giallo
 Nylon Cover for cm. 160
 mannequin with zip
 Colors: red, blue, yellow



5 x Art. 001 + 5 x Art. 001R



5 x Art. 001 + 5 x Art. 001R
 + Art. 003RG

pg.1



Art. BPS001
 Borsa porta 5 sagome in nylon
 impermeabile con tracolla e
 maniglie, rinforzi laterali
 in polipropilene rigido
 Nylon carrying bag for 5
 mannequins with shoulder belt
 and handles, waterproof,
 reinforced on both sides

pg.1

SAGOME BARRET BREVETTATE
 indispensabili per:
*calci di punizione, slalom, dribbling,
 esercizi di anticipo, uscite aeree,
 schemi tattici ...*



PATENTED BARRET MANNEQUINS
 very useful for:
*free kicks, slalom, dribbling, tackles,
 headers, goalkeeper exercises, tactics ...*





**Art. 001
+ Art. 003S**

Art. 003S Carrello porta sagoma in acciaio zincato con ruote, con molle antibaltamento
Trolley for single mannequin in galvanized steel with springs, on wheels

pg.1

Grazie alle molle il carrello Art. 003S impedisce alla sagoma di cadere a terra se colpita dalla palla
Thanks to the springs trolley Art. 003S allows mannequin to come back straight up when hit by the ball



Art. 003S



Art. 001B



**Art. 001
+ Art. 001B**

Art. 001B
Base per sagoma zavorrabile in acciaio zincato, per posizionamento su terreni sintetici
Peso: kg. 10 vuota, kg. 20 riempita con sabbia

Galvanized steel base to be filled with sand for mannequin positioning on artificial grass
Weight: 10 kg. empty 20 kg. filled with sand



Art. SF3454

Base zavorrata in caucciù per posizionamento sagoma su terreni sintetici - peso kg. 13

Rubber base for mannequin positioning on artificial grass - weight 13 kg.

pg.1

**Art. 001
+ Art. SF3454**





Art. 001FE

Art. 001FE
Sagoma Barret
in acciaio zincato
con 4 puntali
altezza cm.180
peso kg.5
 Barret mannequin
 180 cm. height
 in galvanized steel
 with 4 spikes
 weight 5 Kg.



Art. 001FE
 + Art. 001B



Art. 001FE
 + Art. 001R
 + Art. 001B

pg.1

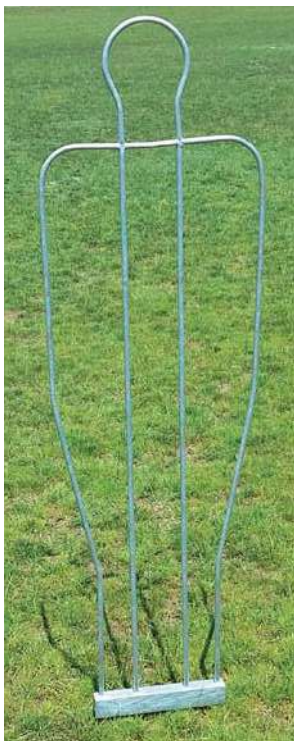

Art. 002FE

Art. 002FE
Sagoma Barret in acciaio
zincato con 4 puntali
altezza cm.160
peso kg.4,5

Barret mannequin
 160 cm.
 height in galvanized steel
 with 4 spikes weight 4,5 Kg.



3 x Art. 001FE + 2 x Art. 001R
 2 x Art. 002FE + 2 x Art. 002R
 + Art. 003



Art. 001TD Rivestimento tridimensionale per sagoma Art. 001
h. cm. 180 spessore cm. 20
in PVC bispalmato 600 gr/mq
imbottitura in gommapiuma d. 16 kg/mc
3D Cover 20 cm. thick
for mannequin Art. 001
180 cm. height

I rivestimenti tridimensionali simulano perfettamente il volume del corpo dei giocatori permettendo una serie di esercizi tecnici e tattici con e senza palla ancora più realistici e sicuri. L'imbottitura è inoltre utile per proteggere la sagoma dagli urti della palla calciata ad alta velocità durante l'allenamento ai calci piazzati di potenza



3D Covers perfectly resemble players' bodies allowing even more realistic and safe technical and tactical exercises with and without ball.

The soft sandwich protections also avoid possible damages caused by high power free kick practising



pg.1

Art. 002TD Rivestimento tridimensionale per sagoma Art. 002
h. cm. 160
spessore cm. 20
in PVC bispalmato
600 gr/mq
imbottitura in gommapiuma
d. 16 kg/mc
3D Cover 20 cm. thick
for mannequin Art. 002
160 cm. height



Art. GP170

Sagoma in gommapiuma
 h. cm. 170 - rivestimento in PVC
 con decorazione digitale
 fronte-retro del giocatore,
 zavorrata alla base con sabbia
 con maniglie per il trasporto
 colori disponibili: rosso, blu,
 giallo, arancio, bianco
 Ø base cm. 59 - peso kg. 31
 Foam rubber Dummy
 170 cm. height with PVC Cover
 with player's sketch
 weighted base with sand
 with handles
 available colors: red, blue,
 yellow, orange, white
 base Ø 59 cm. - weight 31 kg.

**Nessun problema di
 forature, perdite d'aria
 o lacerazioni**
 No problems with
 punctures, deflation or
 lacerations

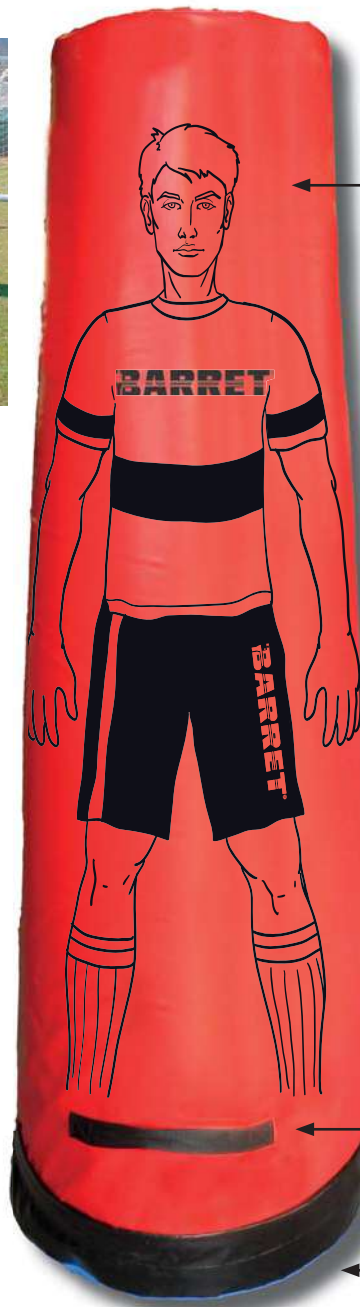

Rivestimento in PVC
 PVC cover outside

**Imbottitura in
 poliuretano espanso**
 Foam rubber inside

pg.1

Art. GP205

Sagoma in gommapiuma
 h. cm. 205 - rivestimento in PVC
 con decorazione digitale
 fronte-retro del giocatore,
 zavorrata alla base con sabbia
 con maniglie per il trasporto
 colori disponibili: rosso, blu,
 giallo, arancio, bianco
 Ø base cm. 59 - peso kg. 32
 Foam rubber Dummy
 205 cm. height with PVC Cover
 with player's sketch
 weighted base with sand
 with handles
 available colors: red, blue,
 yellow, orange, white
 base Ø 59 cm. - weight 32 kg.

**Maniglia
 su entrambi i lati**
 Handle on both
 sides

Base zavorrata
 Weighted base

Art. GP170SL

**Sagoma in
 gommapiuma
 come Art. GP170
 solo con logo
 BARRET (senza
 la decorazione
 del giocatore)**
 Foam rubber
 Dummy same of
 Art. GP170
 only with BARRET
 logo (without
 player's sketch)



Art. GP205SL

**Sagoma in
 gommapiuma
 come Art. GP205
 solo con logo
 BARRET (senza
 la decorazione
 del giocatore)**
 Foam rubber
 Dummy same of
 Art. GP205
 only with BARRET
 logo (without
 player's sketch)

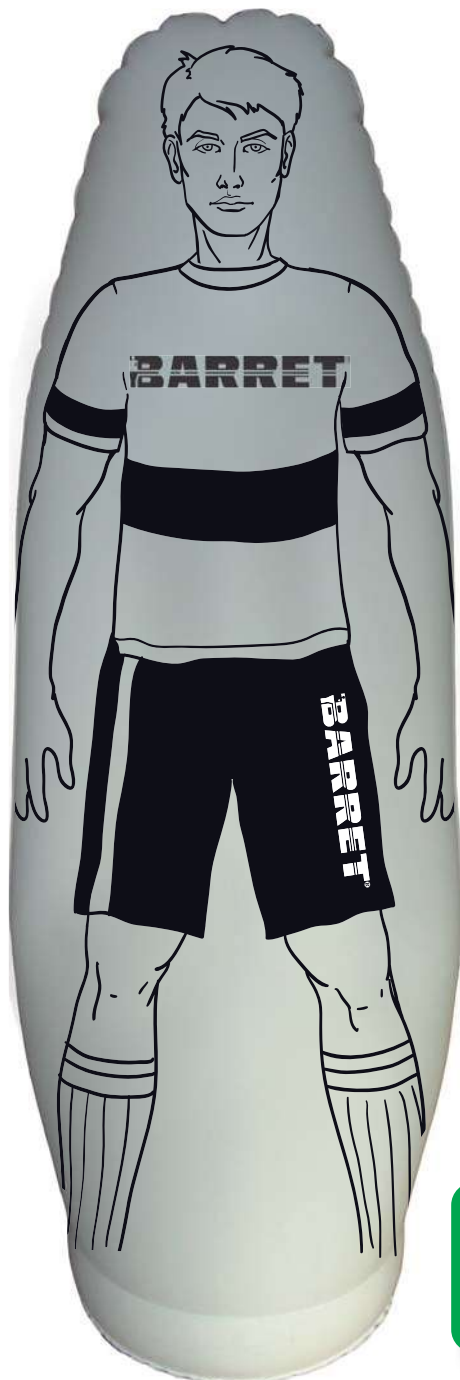

**SEMPRE IN PIEDI
POP UP DUMMIES**

pg.1



**Video dimostrativo
disponibile su
www.barretsport.com
Video available on
www.barretsport.com**

Art. SAG205

Sagoma Gonfiabile

in PVC/PU h. cm.205 colore bianco

Inflatable dummy 205 cm. height white color

Ø base cm. 56 - peso kg. 23 (pronta all'uso)

base Ø 56 cm. - weight 23 Kg.

(when ready for use)

Se colpite dalla palla o dal corpo dei giocatori durante gli esercizi, le sagome gonfiabili Barret tornano in piedi da sole

Barret inflatable dummies always pop back up when hit by ball or players' body during exercises

Nate per l'allenamento dei portieri, le sagome gonfiabili Barret possono essere utilizzate anche per i calciatori per l'effettuazione di una molteplicità di esercizi tecnici e tattici con e senza palla

Born for GK training, Barret inflatable dummies are very useful for lots of tactical and technical exercises involving players with and without ball

Art. SAG205YW

Sagoma Gonfiabile

in PVC/PU h. cm.205 colore giallo

Inflatable dummy 205 cm. height yellow color

Ø base cm. 56 - peso kg. 23 (pronta all'uso)

base Ø 56 cm. - weight 23 Kg.

(when ready for use)

Particolare della valvola superiore (rientrante) da utilizzare per la gonfiatura della sagoma e della valvola inferiore (anch'essa rientrante) da utilizzare per il riempimento della base di appoggio a terra con acqua

The upper valve to inflate the body with air, the bottom valve to fill the base with water



Video dimostrativo
disponibile su
www.barretsport.com
Video available on
www.barretsport.com



Ideale per i bambini
delle scuole calcio
Best for soccer school kids

SEMPRE IN PIEDI
POP UP DUMMIES

pg.1



Art. SAG175
Sagoma Gonfiabile
in PVC/PU h. cm.175
Inflatable dummy 175 cm. height

Ø base cm. 45 - peso kg. 11
(pronta all'uso)
base Ø 45 cm. - weight 11 Kg.
(when ready for use)

Art. SAG115
Sagoma Gonfiabile
in PVC/PU h. cm.115
Inflatable dummy 115 cm. height

Ø base cm. 40 - peso kg. 7
(pronta all'uso)
base Ø 40 cm. - weight 7 Kg.
(when ready for use)

Per un ordine minimo di 100 pezzi per misura
le sagome gonfiabili possono essere personalizzate

Inflatable dummies can be customized:
minimum order 100 pieces for each size

ISTRUZIONI PER LA GONFIATURA E L'UTILIZZO DELLE SAGOME GONFIABILI

IMPORTANTE: LA SAGOMA NON DEVE MAI ESSERE COMPLETAMENTE GONFIA. IL CORPO DEVE RIMANERE SEMPRE MORBIDO, ED I FIANCHI NON DEVONO ESSERE MARCATAMENTE SPORGENTI VERSO L'ESTERNO RISPETTO ALLA BASE

(UNA ECCESSIVA QUANTITÀ D'ARIA LOGORA LE SALDATURE ED ACCORCIA LA VITA DEL PRODOTTO)

- 1) Gonfiare la sagoma **solo moderatamente**
- 2) Tenendo la sagoma distesa a terra, inserire acqua nel serbatoio: quando la sagoma comincia ad inclinarsi verso l'alto, chiudere il tappo del serbatoio e disporla in posizione verticale
- 3) Provare a spingere la sagoma lateralmente e osservare come torna in posizione eretta
- 4) Se si vuole che la sagoma si rialzi più velocemente, aggiungere dell'acqua (a discapito del peso) e gonfiare un po'
- 5) Se si gonfia ulteriormente la sagoma, distenderla a terra e fare uscire l'aria in eccesso dal serbatoio dell'acqua (il fondo deve essere piatto, non bombato)
- 6) E' importante **utilizzare la minima quantità di acqua** che permette alla sagoma di risalire nel modo desiderato (un peso eccessivo e non giustificato può logorare inutilmente le saldature, accorciando la vita del prodotto)
- 7) Una volta trovato l'equilibrio desiderato, la sagoma può essere sgonfiata e rigonfiata (ad esempio, per trasportarla in luogo lontano) senza più svuotare il serbatoio dell'acqua
- 8) Non utilizzare le sagome se la temperatura è più bassa di 5 °C (e in ogni caso non usarle se l'acqua nel serbatoio è ghiacciata)
- 9) Non colpire le sagome con corpi appuntiti, non avvicinarle a fonti di calore, non trascinarle ma sollevarle sempre con le maniglie quando occorre spostarle, non sbatterle violentemente a terra, non lasciarle esposte al sole per giorni
- 10) Per le riparazioni utilizzare l'apposito kit o Loctite 406 (altri prodotti non hanno efficacia sul materiale) Il prodotto è garantito solo per un utilizzo diligente che rispetti le istruzioni fornite



Art. KSG
Kit di riparazione
(collante +
3 porzioni di
rivestimento)
Inflatable dummy
repairing kit



**SEMPRE IN PIEDI
POP UP DUMMIES**



USER'S INSTRUCTIONS

IMPORTANT: YOU ALWAYS HAVE TO KEEP THE BODY OF YOUR DUMMY VERY SOFT (NOT FULLY INFLATED) AND HIPS HAVE TO BE IN A STRAIGHT LINE WITH THE BASE (THEY MUST NOT BE ROUNDED)

(AN EXCESSIVE AMOUNT OF AIR WILL WEAR OUT THE WELDS AND SHORTEN THE TOOL'S LIFE)

Inflatable dummies are entirely made of soft PVC/PU: there are no rigid parts, so these products are absolutely safe. First, you have to inflate your dummy but **not completely**. Then, by keeping it lying on the floor, you have to put some water in the tank: when the dummy rises up, close the valve and place it upright.

If you want your dummy to rise up more quickly when hit, add some water and inflate the body a little more. In this case, let the dummy lie on the floor for a while and let some air out from the tank (the base must be flat, not rounded). It's important you **to use the minimum amount of water** that allows your dummy to rise the desired way (an excessive and unjustified weight will wear out the welds, shortening the tool's life).

Once the desired balance has been found, the dummy can be deflated and re-inflated without emptying the water tank (for example, when you need to transport it to a distant place).

Dummies can be used both on natural and artificial grass, on turf, gym floors etc.

Two side handles made of soft PVC are very useful to carry your dummy around: it is important to always lift your dummy when you need to move it (never pull it!) so the base doesn't get damaged.

Do not use dummies if the temperature is lower than 5 °C (and in any case do not use them if the water in the tank is frozen).

It is also available a kit for repair when inflatable dummies get damaged because used in wrong ways, in example when they are torn apart by players kicking with their studs against them.

**LATO ANTERIORE
FRONT**



**LATO POSTERIORE
BACK**

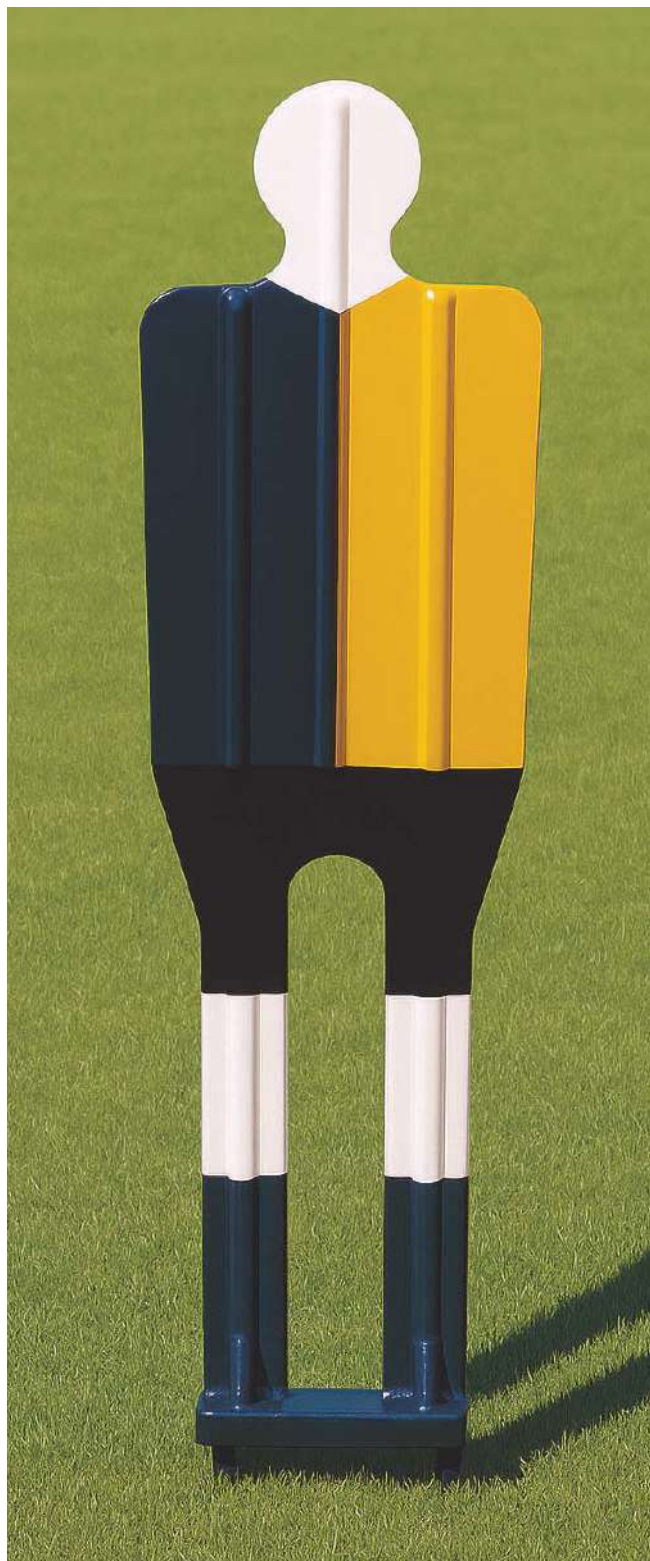

Art. 5026

Sagoma Barret in vetroresina h. cm. 185
Barret fiberglass Mannequin 185 cm. height

**4 puntali in acciaio
zincato alla base,
per posizionamento
su terreno naturale
o su carrello
portasagome**

● pg.1

4 galvanized steel
spikes at the base,
for quick positioning
on natural grass
or on trolley

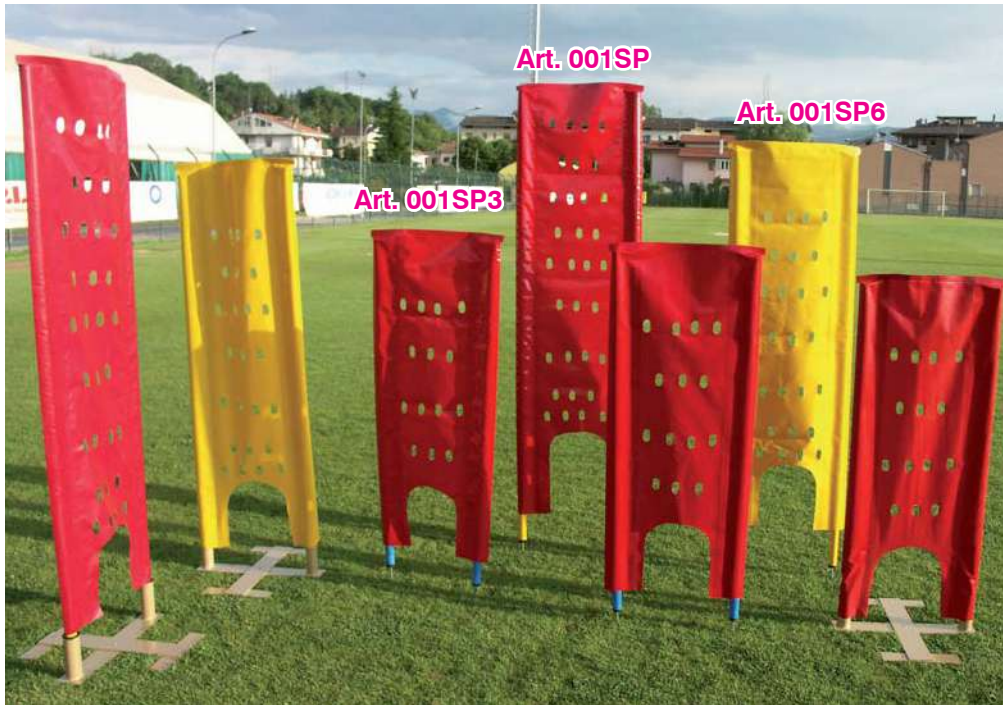

Art. 001SP

Sagoma soft con telo PVC forato antivento su 2 paletti in PVC h. cm. 170 con puntale
Soft pierced antiwind PVC Mannequin on 2 PVC poles 170 cm. high with metal spike

Art. 001SPA

Sagoma soft con telo PVC forato antivento su 2 paletti in alluminio h. cm. 170 con puntale
Soft pierced antiwind PVC Mannequin on 2 aluminium poles 170 cm. high with metal spike

Art. 001SP3

Sagoma soft con telo PVC forato antivento su 2 paletti in PVC h. cm. 130 con puntale
Soft pierced antiwind PVC Mannequin on 2 PVC poles 130 cm. high with metal spike

Art. 001SP6

Sagoma soft con telo PVC forato antivento su 2 paletti in PVC h. cm. 160 con puntale
Soft pierced antiwind PVC Mannequin on 2 PVC poles 160 cm. high with metal spike

pg.1



Art. SA001

Supporto per sagoma soft in ferro verniciato utilizzabile su terreno sintetico
Base in painted iron for positioning any soft mannequin on artificial grass

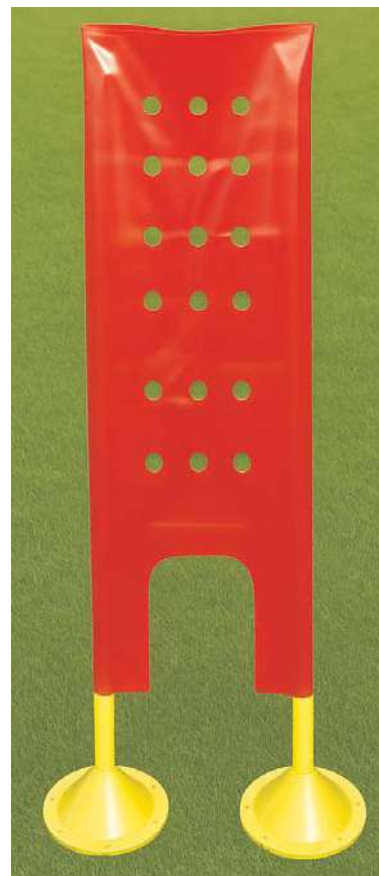

Art. BA001SP

Sagoma soft con telo in PVC h. cm.183 su 2 paletti in PVC senza puntale e 2 basi Art. SP202
Soft pierced antiwind PVC Mannequin 183 cm. height on 2 PVC poles and 2 bases Art. SP202

Art. BA001SPA

Sagoma soft con telo in PVC h. cm.183 su 2 paletti in alluminio senza puntale e 2 basi Art. SP202
Soft pierced antiwind PVC Mannequin 183 cm. height on 2 aluminium poles and 2 bases Art. SP202

PALETTI SLALOM - Slalom Poles

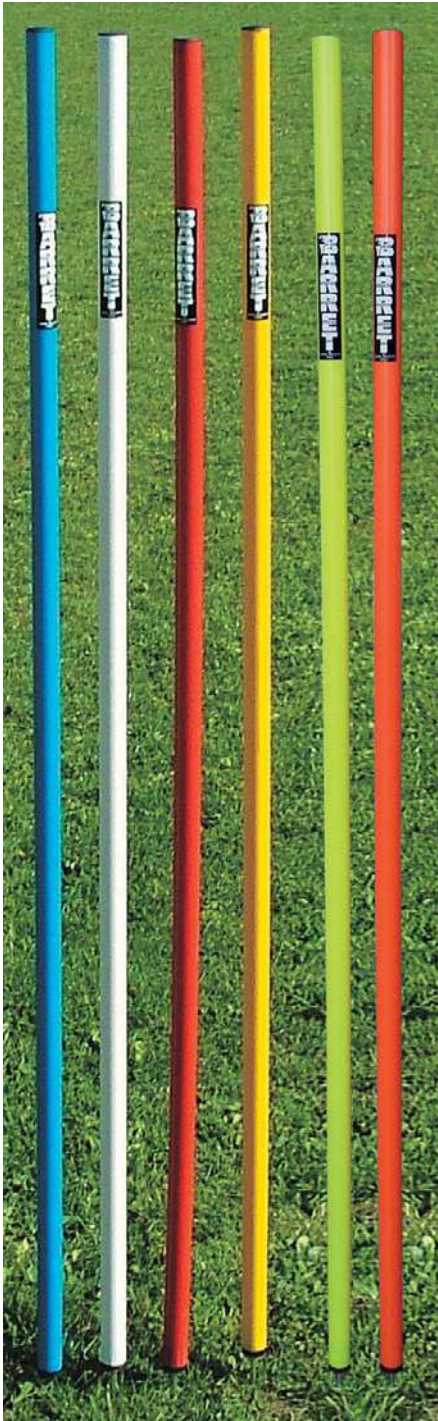

pg.2

Art. 007
Paletto cm. 170
in PVC Ø mm. 32
con puntale zincato
colore giallo, giallo fluo,
rosso, bianco, blu, arancio
Pole 170 cm. high
in PVC with
galvanized metal spike
colors: yellow, fluo yellow,
red, white, blue, orange



Art. 007.40 / 007.90 / 007.110
Paletto cm. 40 / 90 / 110
in PVC Ø mm. 32
con puntale zincato
colore giallo, giallo fluo, rosso,
bianco, blu, arancio
Pole 40 / 90 / 110 cm. high
in PVC with
galvanized metal spike
colors: yellow, fluo yellow, red,
white, blue, orange

**Altre altezze
su richiesta
Other heights
on request**



Art. BFT
Borsa porta paletti
(capacità massima
30 pezzi)
Bag containing
up to 30 poles
(poles not included)

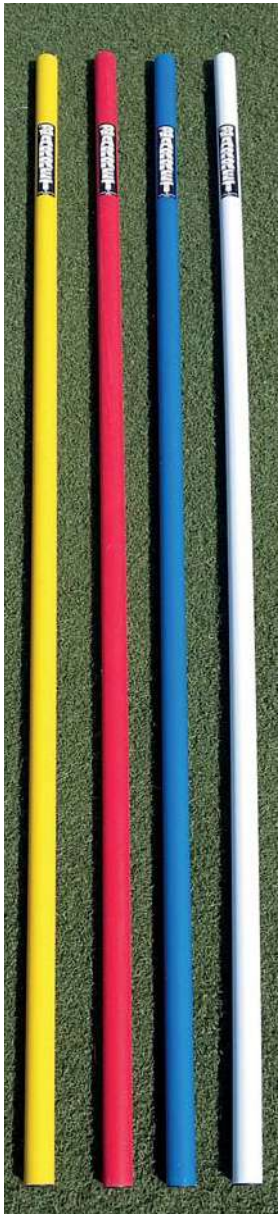

Art. 007SP
Paletto senza puntale
cm. 162
in PVC Ø mm. 32
colore giallo fluo,
rosso, bianco, blu
 Pole 162 cm. high
 in PVC
 colors: fluo yellow,
 red, white, blue

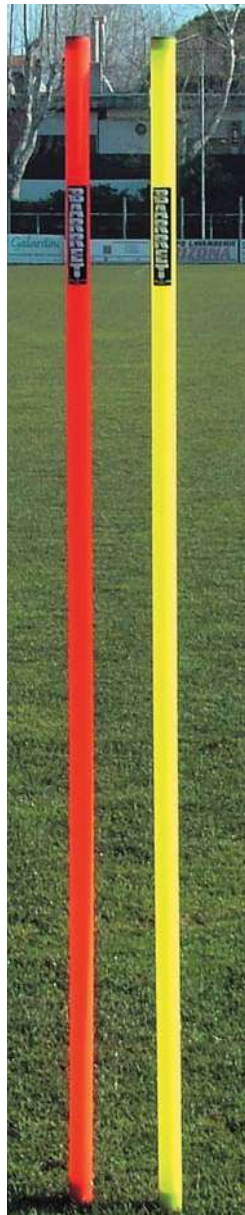

Art. 007F
Paletto cm. 163
in polipropilene
copolimero Ø mm. 32
con puntale zincato,
colore giallo fluorescente
o arancio fluorescente
 Pole 163 cm. high in
 copolymer polypropylene
 32 mm. with galvanized metal
 spike - colors: fluorescent
 yellow and fluorescent orange

pg.2



Art. P007
Paletto cm. 160
in polipropilene
Ø mm. 30 con
puntale e piattello
di appoggio,
colore giallo fluo
 Pole 160 cm. high
 in polypropylene
 with metal spike
 and ring
 color fluo yellow



Art. A007
Paletto cm. 170
in alluminio Ø mm. 32
con puntale zincato
 Pole 170 cm. high
 in aluminium with
 galvanized metal spike



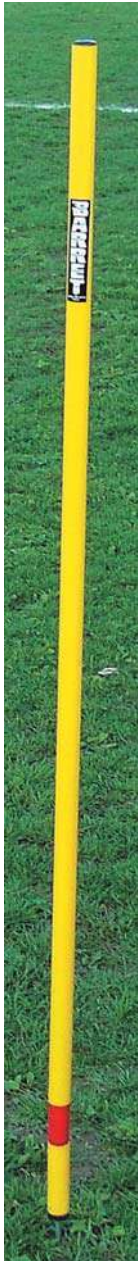

pg.2



Art. S007
Paletto flessibile
 cm. 170 in
 PVC Ø mm. 32 con
 puntale
 zincato e molla,
 colore giallo o rosso
 Pole 170 cm. high
 in PVC with
 galvanized metal
 spike and spring
 colors: yellow, red



Art. AS007
Paletto flessibile
 cm. 170 in
 alluminio Ø mm.
 32 con puntale
 zincato e molla
 Pole 170 cm. high
 in aluminium with
 galvanized metal
 spike and spring



cm. 170

cm. 90



Art. 007TL
Paletto telescopico
 cm. 170 in PVC
 Ø mm. 32
 con puntale zincato
 (l'altezza si riduce
 fino a cm.90)
 colore giallo
 Telescopic Pole 170 cm.
 high in PVC with galvanized
 metal spike
 (height can be reduced
 down to 90 cm.)
 color yellow

pg.2



Art. 007.25
Paletto
 cm. 170
 smontabile
 in PVC
 Ø mm. 25
 con puntale
 zincato svitabile
 colore giallo
 Dismountable
 Pole 170 cm.
 high in PVC
 with removable
 galvanized metal
 spike
 color yellow





Art. 018

Base ad imbuto in plastica per paletto Ø mm. 32 con o senza puntale
Funnel-shaped plastic base for pole with or without metal spike



Art. 902013

Base cilindrica in plastica riempibile con sabbia o acqua, solo per paletto Ø mm. 32 senza puntale
Cylindrical plastic base to be filled with sand or water, only for pole without metal spike

pg.2



Art. HWRB

Base in gomma appesantita per paletto Ø mm. 32 con o senza puntale
Weighted Rubber base for pole with or without metal spike



Art. SP202 Base ad imbuto in plastica riempibile con sabbia, solo per paletto Ø mm. 32 senza puntale
Funnel-shaped plastic base to be filled with sand, only for pole without metal spike



h. cm. 173

Art. 010
Kit paletto PVC Ø mm. 32 senza puntale
Art. 007SP + base Art. 018
Kit pole without metal spike + base Art. 018



h. cm. 170

Art. 010C
Kit paletto PVC Ø mm. 32 senza puntale
Art. 007SP + base Art. 902013
Kit pole without metal spike + base Art. 902013



h. cm. 176

Art. 010WR
Kit paletto PVC Ø mm. 32 senza puntale
Art. 007SP + base Art. HWRB
Kit pole without metal spike + base Art. HWRB

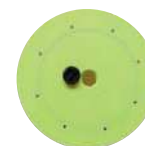

h. cm. 173

Art. S111P Kit paletto PVC Ø mm. 32 senza puntale
Art. 007SP + base Art. SP202
Kit pole without metal spike + base Art. SP202

pg.2



Art. TAH-X
Base riempibile con sabbia per paletto Ø mm. 25 e cerchio piatto o tubolare
colori: giallo, blu e rosso
 Base to be filled with sand for pole Ø 25 mm. and flat or tubular hoop
 colors: yellow, blue and red

Art. SP25
Paletto cm. 152
in PVC Ø mm. 25
colori: giallo, blu e rosso
 Pole 152 cm. high
 in PVC Ø 25 mm.
 colors: yellow, blue and red

Art. TAH25
Kit paletto in PVC Art. SP25
+ base riempibile Art. TAH-X
 Kit PVC pole Art. SP25
 + base Art. TAH-X

pg.2



Art. BC3V
Base in gomma appesantita per inserire fino a 3 paletti in PVC
Ø mm. 25 con diverse angolazioni - peso Kg. 1,3 Ø cm. 22,5
 Rubber weighted base to insert up to 3 PVC poles Ø 25 mm.
 with different angles - weight 1,3 Kg. Ø 22,5 cm.

Art. BC3V + Art. SP25

pg.2

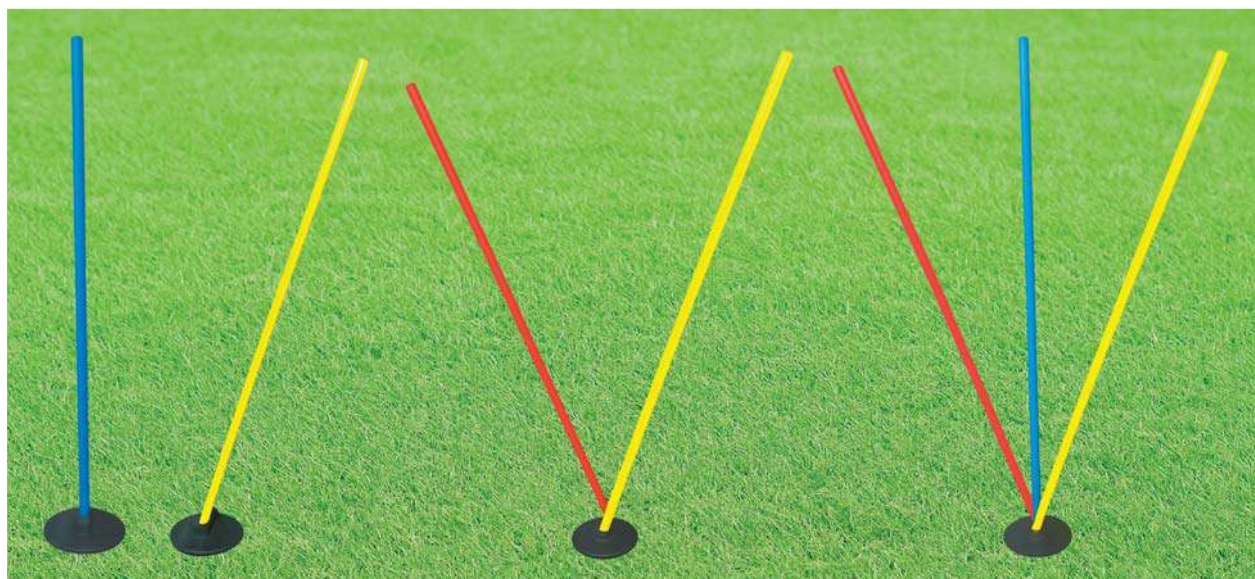

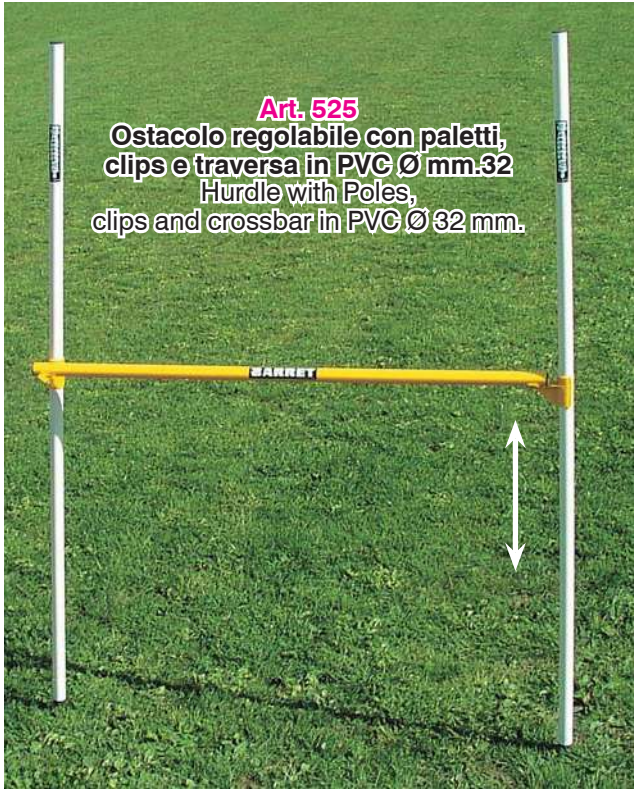

Art. 525
Ostacolo regolabile con paletti, clips e traversa in PVC Ø mm.32
 Hurdle with Poles, clips and crossbar in PVC Ø 32 mm.

pg.2

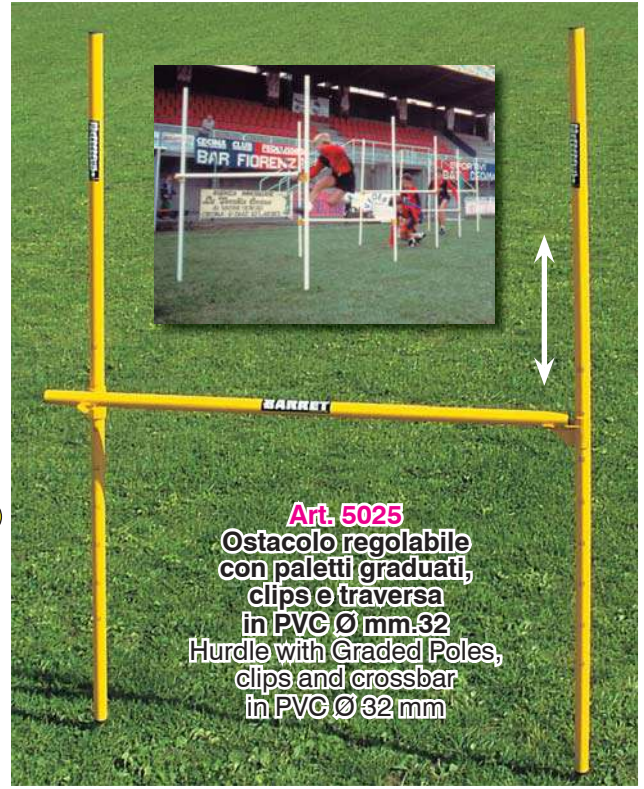

Art. 5025
Ostacolo regolabile con paletti graduati, clips e traversa in PVC Ø mm.32
 Hurdle with Graded Poles, clips and crossbar in PVC Ø 32 mm

h. cm. 10 → 160



Art. 012
Traversa in PVC cm.110 Ø mm. 32
 Crossbar 110 cm. in PVC Ø 32 mm.



Art. 012F
Traversa in polipropilene copolimero cm. 110 Ø mm.32 giallo fluo o arancio fluo
 Crossbar 110 cm. in copolymer polypropylene Ø 32 mm. in fluo yellow and fluo orange

pg.3



Art. 525F
Ostacolo regolabile con paletti h. cm. 163 con puntale, 1 traversa e 2 clips in polipropilene copolimero colore giallo fluo o arancio fluo
 Hurdle with graded poles, clips and crossbar in copolymer polypropylene Ø 32 mm. (colors: fluo yellow and fluo orange)

h. cm. 10 → 160

pg.3



Art. ELNR
ELASTICO nero con velcro lunghezza cm.135 da fissare ai paletti come traversa ad altezza regolabile
 Black band length 135 cm. with velcro to be used as adjustable height crossbar

DELIMITATORI - Markers

SPECIFICARE I COLORI RICHIESTI AL MOMENTO DELL'ORDINE

PLEASE, SPECIFY COLORS IN YOUR ORDER



**Si può richiedere il singolo kit
in colori misti**
You can request a single kit
in mixed colors



Art. 016

**Kit 48 Delimitatori h. cm.5 con rimessaggio
colori disponibili:**
giallo fluo, rosso, fucsia, arancio fluo, blu, bianco
Kit 48 Markers h. 5 cm. with holder
(colors: fluo yellow, red, fuchsia, fluo orange, blue, white)

Art. 016.B

**Kit 48 Delimitatori h. cm.8 con rimessaggio
giallo fluo, rosso, fucsia, arancio fluo, blu, bianco**
Kit 48 Markers 8 cm. height with holder
(fluo yellow, red, fuchsia, fluo orange, blue, white)

Art. 016.1

**Kit 48 Delimitatori h. cm.5 senza rimessaggio
(come Art. 016 senza rimessaggio)**
Kit 48 Markers h. 5 cm. without holder

pg.3



Art. 016.R

**Rimessaggio in ferro
per delimitatori
h. cm.8 e delimitatori
giganti Art. 016.K**
Iron Holder for 8 cm.
and giant markers



**Art. 016.R5 Rimessaggio in plastica
per delimitatori h. cm.5 e cm.7**
Plastic Holder for 5 cm. and 7 cm.
height markers



Art. 016-TDC
**Raccoglitore in plastica per delimitatori
con manico allungabile**
Adjustable length picking device for markers



Art. 016.T



Art. 016.T

**Kit 48 Delimitatori h. cm. 7
con rimessaggio
e intagli sulla sommità**
colori disponibili: giallo e rosso

Kit 48 Markers with holder 7 cm. height carved on top
(colors: red and yellow)

Art. OSPT15 Delimitatore circolare piatto Ø cm.15 spessore mm.1 colori giallo, rosso, arancio, bianco, celeste
Flat round Marker Ø 15 cm. colors: red, yellow, orange, white, blue

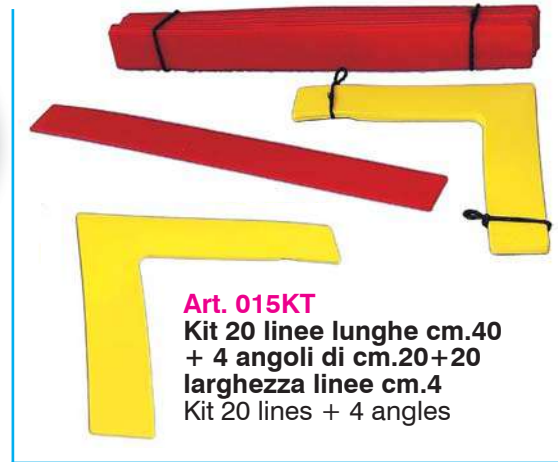
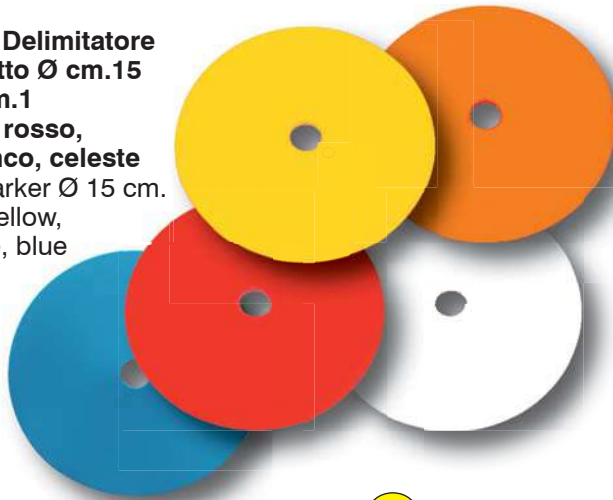

Art. 015KT
Kit 20 linee lunghe cm.40 + 4 angoli di cm.20+20 larghezza linee cm.4
Kit 20 lines + 4 angles

pg.3



Max 40 pcs

Art. 15HCR Rimessaggio in metallo per delimitatori piatti Art. OSPT15
Metal Holder for Art. OSPT15

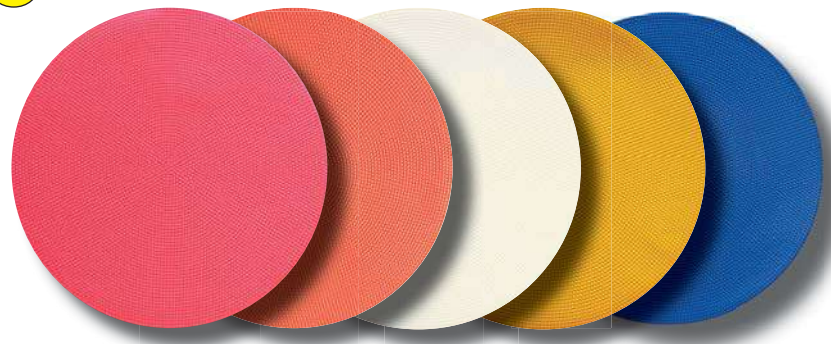

Art. DC25
Delimitatore circolare piatto Ø cm.25 spessore mm.1 colori giallo, rosso, arancio, bianco, blu
Flat round Marker Ø 25 cm. colors: red, yellow, orange, white, blue



Art. 016.K
Delimitatore gigante con scanalature base Ø cm. 30 h. cm.16,5 peso gr. 100 colori: giallo, arancio e bianco
Giant Marker 16,5 cm. height carved on top and sides colors yellow, orange and white

pg.3

Con l'uso di traverse consente di creare ostacoli di altezza cm. 5 / 10 / 15
Giant markers along with crossbars can create hurdles 5-10-15 cm. high



Art. E21



Art. E21 Traversa cm.120 in PVC Ø mm. 25 - colori giallo, rosso, blu, verde, bianco
Crossbar 120 cm. in PVC Ø 25 mm. - colors yellow, red, blue, green, white

BIRILLI - Cones

Art. 205000
Birillo calpestabile
in caucciù termoplastico
base Ø cm. 14 - h. cm. 15
colori giallo e rosso
 Soft Cone 15 cm. height
 14 cm. Ø base
 colors: red, yellow



Art. HA7
Birillo calpestabile
in caucciù
termoplastico
base Ø cm. 17
h. cm. 18
colori giallo e rosso
 Soft Cone
 18 cm. height and
 17 cm. Ø base
 colors: red, yellow

pg.3



Art. 019.1
Maxidelimitatore h. cm. 28
fornito singolarmente
colori: giallo, arancio, rosso,
royal e fucsia
 Loose Maximarker height 28 cm.
 colors: yellow, orange, red, blue
 and fuchsia



Art. 019.1



Art. 019
Kit 24 Maxidelimitatori h. cm. 28
colori: giallo, arancio, rosso, royal e fucsia
 Kit 24 Maximarkers height 28 cm.
 colors: yellow, orange, red, blue and fuchsia

Si può richiedere il singolo kit in colori misti
 You can request a single kit in mixed colors



Art. 023E
Birillo economico
senza fori h. cm. 30
colori rosso e giallo
 Light Cone
 30 cm. height
 with no holes
 colors: red,
 yellow



Art. 023N

Birillo h. cm. 38 colore rosso, giallo o blu - Cone height 38 cm. colors: red, yellow, blue
Peso gr. 200 senza foro sulla sommità - Weight 200 gr. with no hole at top



**Peso gr. 450
Weight 450 gr.**

Art. 023

Birillo giallo h. cm. 40 con foro sulla sommità
 Yellow Cone 40 cm. height with hole at the top

Art. 025

Birillo fucsia h. cm. 40 con foro sulla sommità
 Fuchsia Cone 40 cm. height with hole at the top

Art. 024

Birillo rosso h. cm. 40 con foro sulla sommità
 Red Cone 40 cm. height with hole at the top

● pg.3



**In 4 colori
In 4 colors**

Art. B312

Birillo a 8 fori h. cm. 30 con scanalatura sulla sommità
 Cone with 8 holes 30 cm. height carved on top



Art. E21 Traversa cm.120 in PVC Ø mm. 25 colori giallo, rosso, blu, verde, bianco

Crossbar 120 cm. in PVC Ø 25 mm. - colors yellow, red, blue, green, white



Art. I-111
Clip rotante
per aste
 Ø mm. 25 e 28
 Rotating clip
 for two pipes
 Ø mm. 25 and 28



Art. C21
Birillo a 16 fori
h. cm. 50
con scanalatura
sulla sommità
 Cone with 16 holes
 height 50 cm.
 carved on top

pg.3

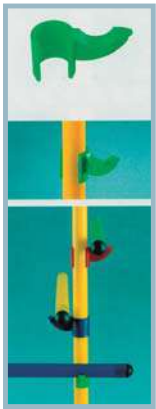

Art. I-110
Clip per montante
 Ø mm. 25 e 28
e traversa
 Clip for pipe
 Ø mm. 25 and 28
 and crossbar

pg.4

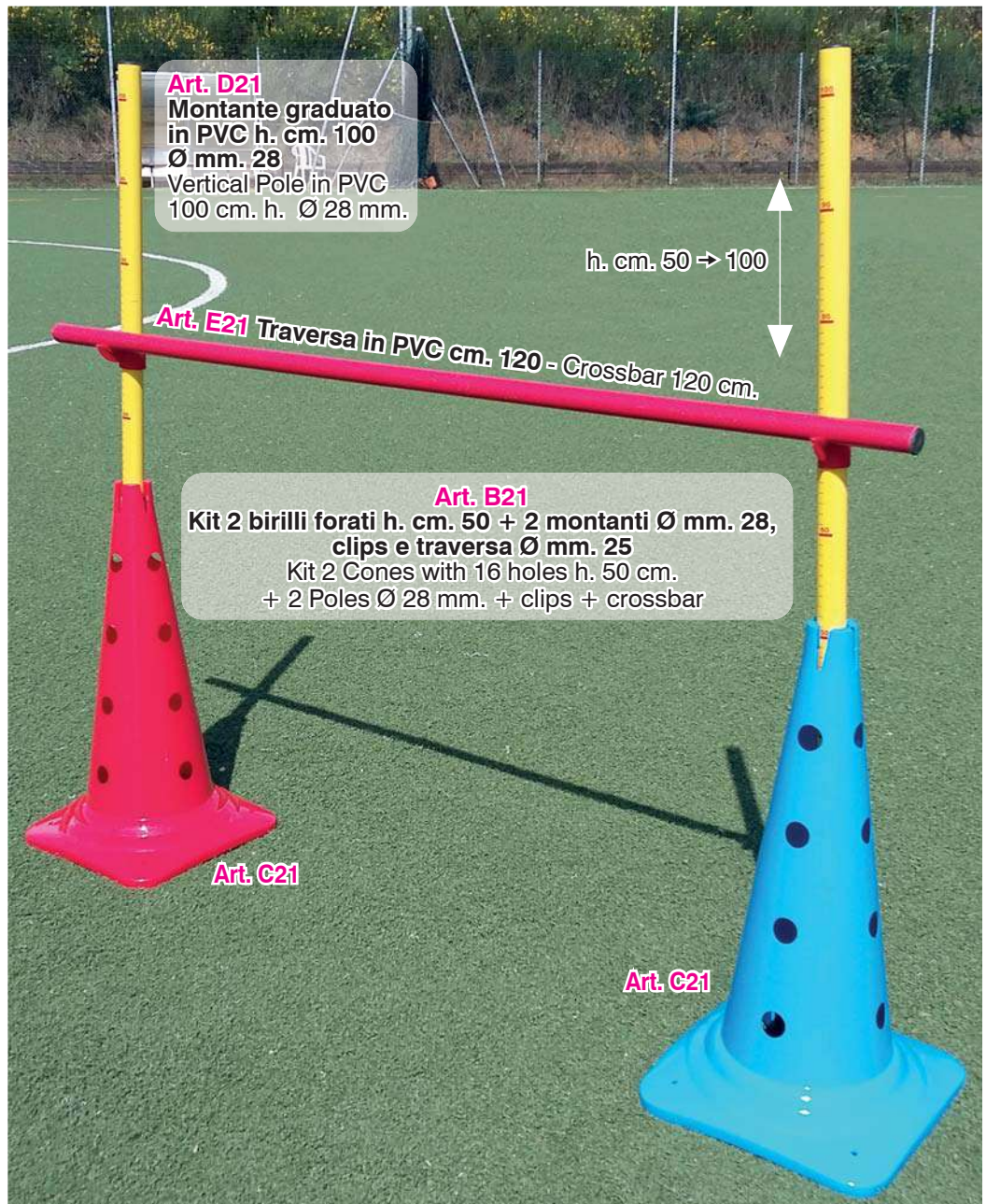

Art. D21
Montante graduato
in PVC h. cm. 100
 Ø mm. 28
 Vertical Pole in PVC
 100 cm. h. Ø 28 mm.

h. cm. 50 → 100

Art. E21 Traversa in PVC cm. 120 - Crossbar 120 cm.

Art. B21
Kit 2 birilli forati h. cm. 50 + 2 montanti Ø mm. 28,
clips e traversa Ø mm. 25
 Kit 2 Cones with 16 holes h. 50 cm.
 + 2 Poles Ø 28 mm. + clips + crossbar

Art. C21

Art. C21



Art. I-112
Clip per asta
 Ø mm. 25 e 28
e cerchio piatto
 Clip for pipe
 Ø mm. 25 and 28
 and flat hoop

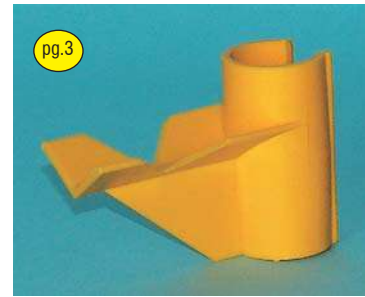

Art. 011
Clip per sostegno traversa per asta Ø mm. 32 e 28
Clip for crossbar for pipe Ø mm. 32 and 28



Art. CL17
Clip rotante per aste Ø mm. 32
Rotating clip for two pipes Ø 32 mm.

pg.2

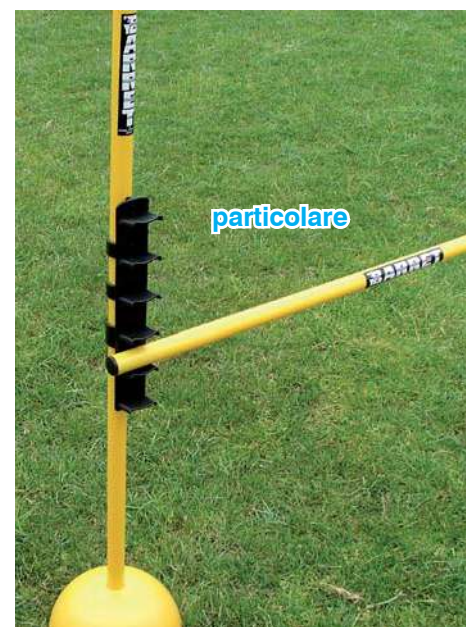

OSTACOLI - Hurdles



pg.5

Art. MH6 / MH9 / MH12
Mini-Over in PVC
altezza fissa,
cm. 15 / 23 / 30
Ideali per i bambini
delle scuole calcio

Mini-Over in PVC
fixed height,
15 / 23 / 30 cm.
Best for soccer
school kids



Tornano in posizione
dopo ogni urto
senza danneggiarsi
These hurdles come
back in position after
any hit without being
damaged

pg.4

Art. 80.12 / 80.14 / 80.16 / 80.18
80.20 / 80.30 / 80.40 / 80.50 / 80.60
Ostacolo Over in PVC
altezza fissa,
cm.12-14-16-18-20-30-40-50-60
Hurdle Over in PVC
fixed height,
12-14-16-18-20-30-40-50-60 cm.

pg.4

Art.
P031-A / P031 / P032
P033 / P034 / P035
Ostacolo Over
in PVC Ø mm. 32
altezza fissa
disponibile
da 12 a 60 cm.
Hurdle Over in PVC,
fixed height
available
from 12 to 60 cm.



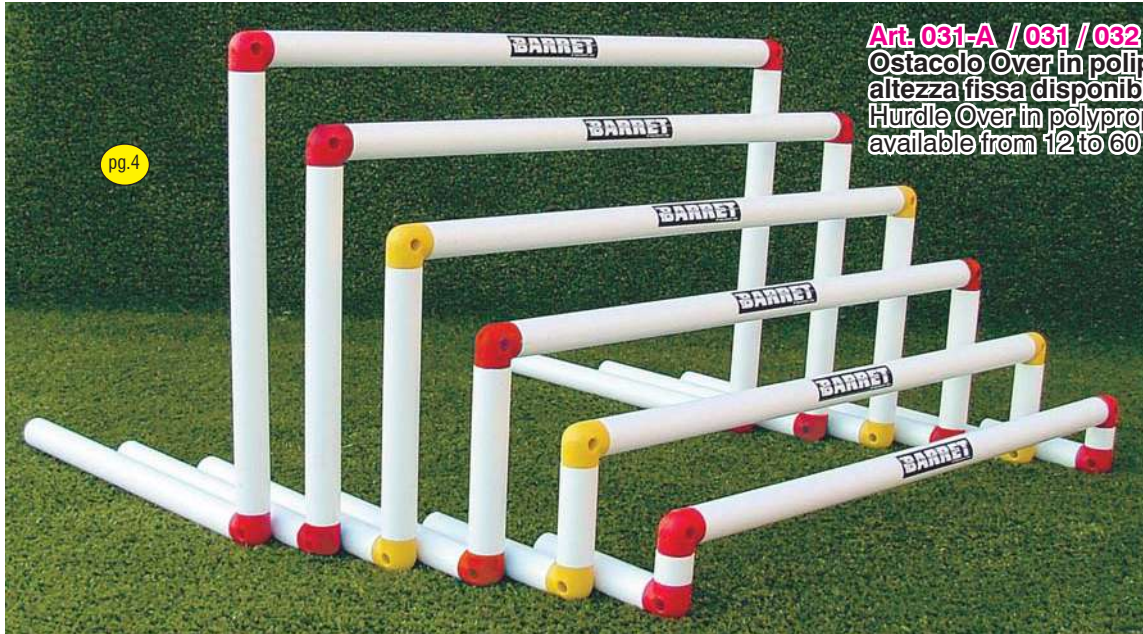

pg.4

Art. 031-A / 031 / 032 / 033 / 034 / 035
Ostacolo Over in polipropilene Ø mm. 40
altezza fissa disponibile da 12 a 60 cm.
Hurdle Over in polypropylene, fixed height
available from 12 to 60 cm.

**Polipropilene
copolimero
Ø 40 mm.
altamente
resistente e
flessibile fino a
-5 gradi!**
Polypropylene
copolymer
40 mm. highly
resistant and
elastic till minus
5 degrees!

pg.5



Art. 235-1 / 235.2 / 235.3 / 235.4 / 235.5 / 235.6
Ostacolo Over
in ferro verniciato altezza fissa
disponibile da 12 a 60 cm.
Hurdle Over in painted iron,
fixed height available
from 12 to 60 cm.



pg.5

Art. A031-A / A031 / A031-B / A032 / A033 / A034 / A035
Ostacolo Over in alluminio Ø mm. 32 altezza fissa disponibile da 12 a 60 cm.
Hurdle Over in aluminium, fixed height available from 12 to 60 cm.



pg.5

Art. 239TI

Ostacolo con traversa inclinata altezza variabile da cm. 12 a cm. 60 in ferro verniciato - larghezza mt. 2 (scomponibile) Ordinare quantità multipla di 3 pezzi
 Hurdle with inclined crossbar height from 12 cm. to 60 cm. in painted iron - width 2 meters (dismountable in 3 pieces) Please order multiple quantities of 3 pieces

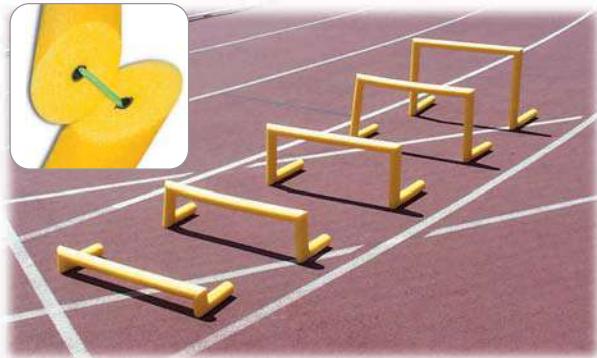

pg.5

Art. P15421

Serie 5 ostacoli Over supersoft in polietilene espanso colore giallo, leggerissimi ideali per uso indoor
 altezza cm. 10-20-30-40-50 (il set comprende un ostacolo per ciascuna altezza)
 Set of 5 Hurdles over supersoft yellow color very light, best for indoor use fixed height cm. 10-20-30-40-50

Art. 031-AF
031F / 031-BF / 032F
033F / 034F / 035F

Ostacolo Over
 altezza fissa
 cm. 12-20-30-40-50-60
 in polipropilene
 copolimero
 alta resistenza
 Ø mm. 32
 colori: giallo fluo e
 arancio fluo
 Over Hurdle 12 - 20 - 30
 40 - 50 - 60 cm. height
 polypropylene
 copolymer
 pipe Ø mm. 32
 (colors: fluo
 yellow and fluo orange)



pg.4

Polipropilene
copolimero
FLUO
 altamente
 resistente e
 flessibile fino a
 -5 gradi!
 Polypropylene
 copolymer
 fluorescent
 highly
 resistant and
 elastic till minus
 5 degrees!

Art. C031 / C032 / C033 / C034

Ostacolo
 con cerniere (richiudibile)
 in polipropilene
 copolimero Ø mm. 32
 colore giallo fluo
 o arancio fluo
 massima altezza
 cm. 20 - 30 - 40 - 50
 Hinged Hurdle
 (foldable) in polypropylene
 copolymer pipe Ø mm. 32
 fluo yellow and fluo orange
 20 - 30 - 40 - 50 cm.
 maximum height



pg.4



Art. 006
Ostacolo con cerniere (richiudibile)
altezza regolabile da 10 a 60 cm.
in PVC Ø mm. 32
Hinged Hurdle (foldable)
adjustable height
from 10 to 60 cm. in PVC



pg.5

Art. 006F
Ostacolo con cerniere (richiudibile)
altezza regolabile da 10 a 60 cm.
in polipropilene copolimero Ø mm. 32
colore giallo fluo o arancio fluo
Hinged Hurdle (foldable) adjustable height
from 10 to 60 cm. in polypropylene
copolymer pipe Ø 32 mm.
(colors: fluo yellow and fluo orange)



Art. A004 **Ostacolo con cerniere (richiudibile)**
altezza regolabile da 10 a 60 cm.
in alluminio Ø mm. 32
Hinged Hurdle (foldable) adjustable height
from 10 to 60 cm. in aluminium



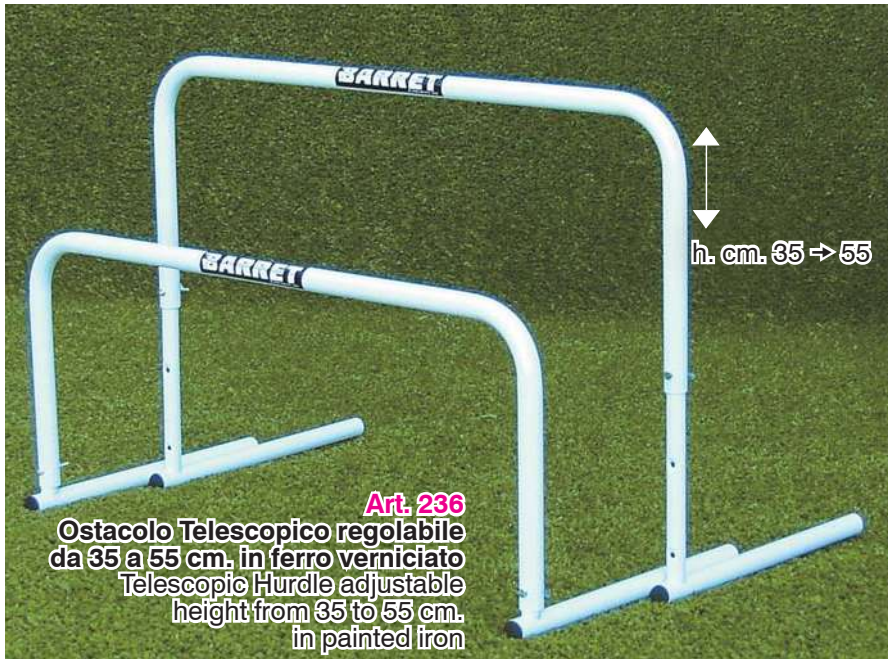

pg.5

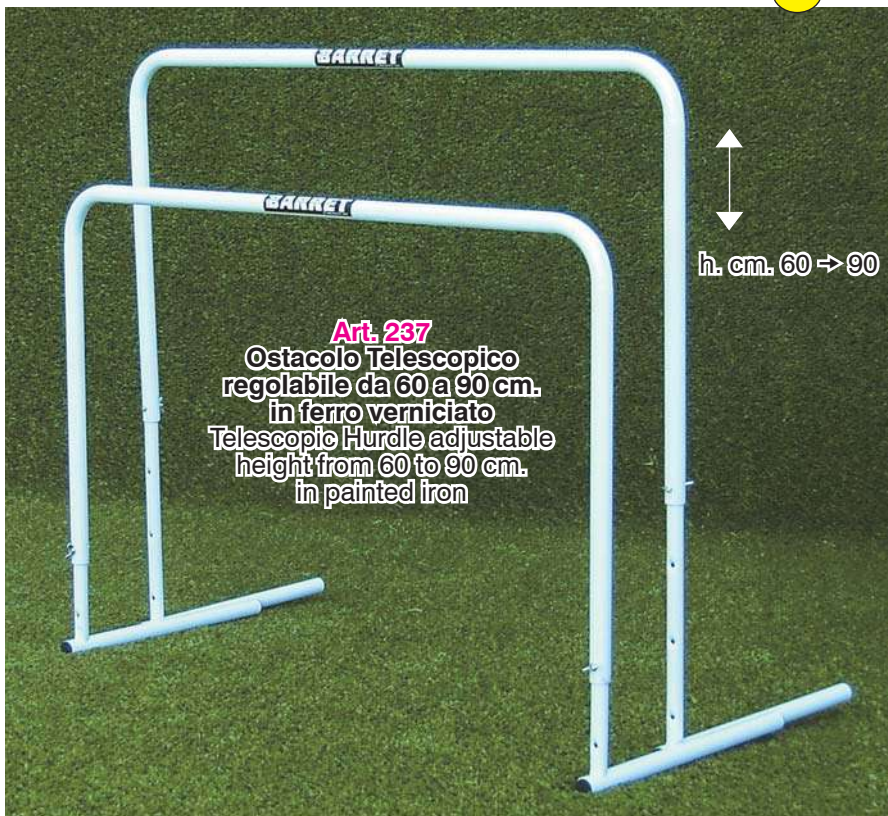

Art. H6912
Mini-Ostacolo per bambini
in plastica antiurto
larghezza traversa cm. 45
altezza regolabile a cm. 15-23-30
Mini-Hurdle
for kids in plastic
45 cm. wide
adjustable height
at 15-23-30 cm.

pg.6



Art. 036
Mini-Ostacolo
per bambini
in plastica
regolabile
da 10 a 50 cm.
Mini-Hurdle for kids
in plastic adjustable
height from 10 to 50 cm.

pg.6

IDEALI PER USO
INDOOR
E PER PALESTRE

For indoor use

Art. P0055
Ostacolo Telescopico graduato,
altezza regolabile
da 40 a 60 cm. in PVC

Telescopic Hurdle - graded - height adjustable
from 40 to 60 cm. in PVC



Art. P0055

Completamente smontabili,
minimo ingombro!
Dismountable legs,
easy to transport

pg.5

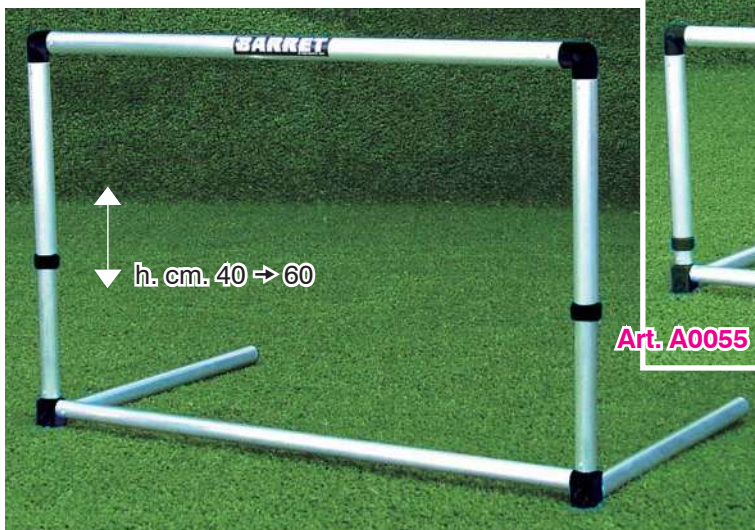

Art. A0055

Art. A0055
Ostacolo Telescopico graduato, altezza regolabile
da 40 a 60 cm. in alluminio
Telescopic Hurdle - graded - height adjustable
from 40 to 60 cm. in aluminium

Montanti graduati
in cm.
Graded in cm.

Completamente
smontabili,
minimo ingombro!
Dismountable legs,
easy to transport



Art. P005
Ostacolo Telescopico graduato,
altezza regolabile da 60 a 100 cm. in PVC
Telescopic Hurdle - graded - height adjustable
from 60 to 100 cm. in PVC

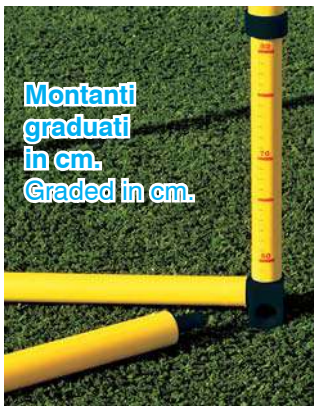
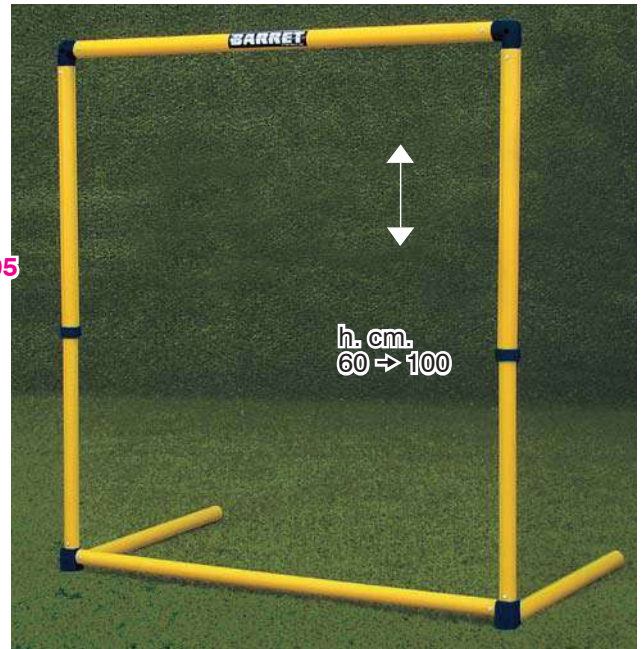
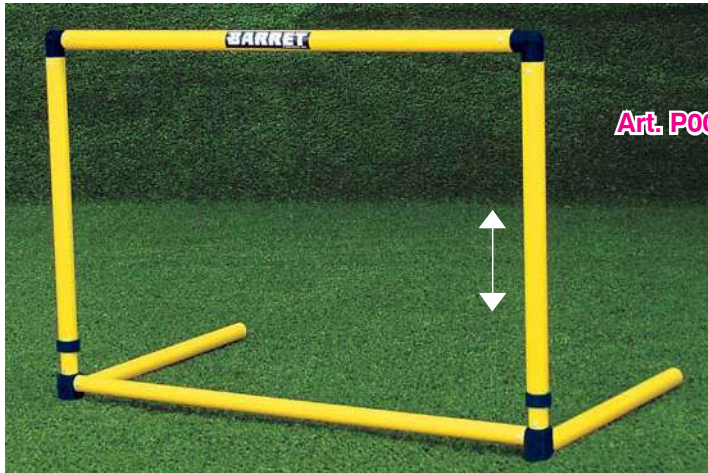

Completamente smontabili,
minimo ingombro!
Dismountable legs,
easy to transport



pg.5

Art. A005
Ostacolo Telescopico graduato,
altezza regolabile da 60 a 100 cm. in alluminio
Telescopic Hurdle - graded
height adjustable from 60 to 100 cm. in aluminium

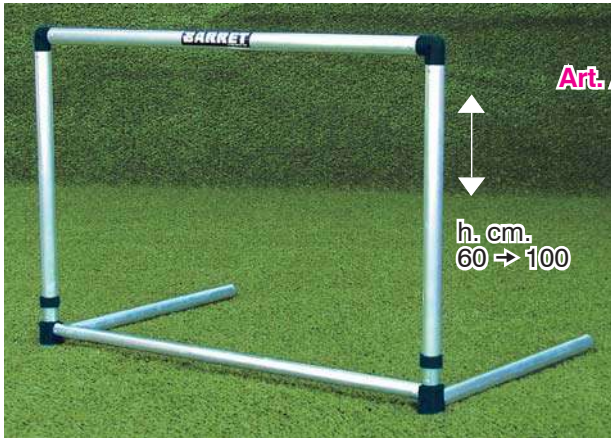

Completamente smontabili,
minimo ingombro!
Dismountable legs,
easy to transport

Montanti graduati in cm.
Graded in cm.





**SEMPRE IN PIEDI
DOPO OGNI URTO!
THEY ALWAYS COME
BACK UP AFTER
ANY HIT!**



pg.5

Art. 5020 / 5021 / 5022 / 5023
Ostacolo Basculante in PVC Ø mm. 28
altezza fissa cm. 30 / 40 / 50 / 60
Self-Straightening Hurdle in PVC fixed height,
available in 30 / 40 / 50 / 60 cm.

pg.5

Art. A5020 / A5021 / A5022 / A5023
Ostacolo Basculante in alluminio Ø mm. 28
altezza fissa cm. 30 / 40 / 50 / 60
Self-Straightening Hurdle in aluminium
fixed height, available in 30 / 40 / 50 / 60 cm.



**SEMPRE IN PIEDI
DOPO OGNI URTO!
THEY ALWAYS COME
BACK UP AFTER
ANY HIT!**



KIT CALCIO TENNIS - Soccer Tennis Kits



pg.6



Art. 013.G Kit calcio tennis pali in PVC con rete mt.10 - altezza cm.130 con tiranti, picchetti e sacca per terreni naturali
Soccer Tennis Kit PVC poles 10 meter long 130 cm. height net with ropes, steel hooks and bag for natural grass



pg.6



Art. 013.P
Kit calcio tennis con rete mt. 3 utilizzabile anche su terreni sintetici o indoor con sacca
Soccer Tennis Kit 3 meter net - with bag also for artificial grass or indoor

Art. 013.SP

**Kit calcio tennis con rete cm.
450x170
utilizzabile anche
su terreni sintetici o indoor**

con sacca

Soccer Tennis Kit 4,5x1,7 meter net
with bag, also for artificial grass
or indoor

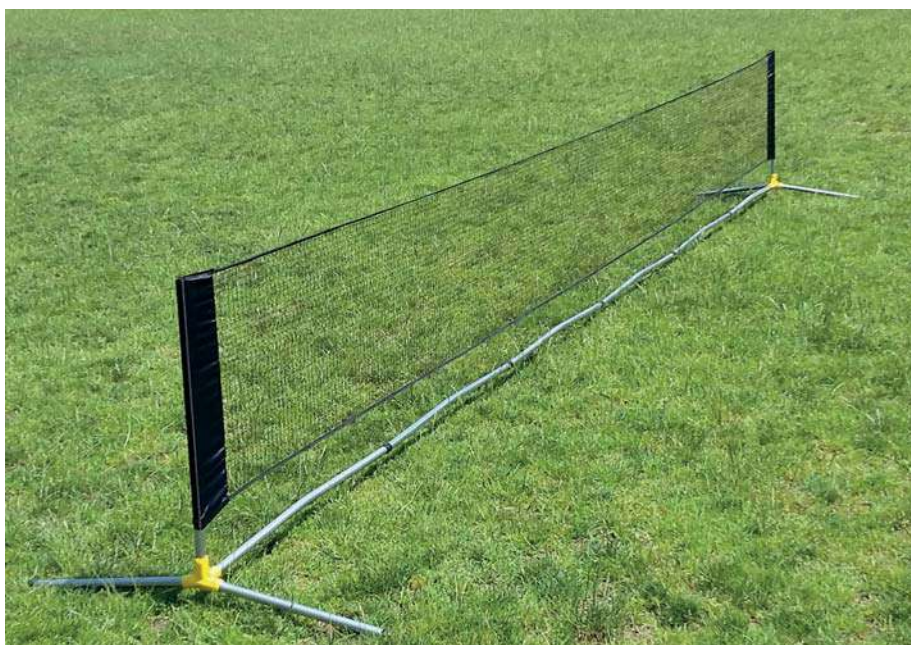

● pg.6

Art. 013.60

**Kit calcio tennis
con rete cm. 600x90
utilizzabile anche
su terreni sintetici
o indoor con sacca**

Soccer Tennis Kit
6,0x0,9 meter net
with bag, also
for artificial grass
or indoor



Art. 013.S

**Kit Calcio Tennis TATTICO
pali in polipropilene
completo di rete in PVC mt. 2,30 regolabile in
altezza, tiranti e basi in ferro verniciato
utilizzabile anche su terreni sintetici o indoor**

Soccer Tennis Kit polypropylene poles
with adjustable height PVC net 2,30 meter long,
tightening ropes and painted steel bases
also for artificial grass or indoor

**Nasconde per qualche istante la visione
del pallone, determinando risposte a livello
neuromuscolare e migliorando cinestesia e
sensibilità nel tocco di palla**

This Soccer Tennis Kit hides the ball from
player's visibility stimulating neuro muscular
reflexes and improving ball control

● pg.6



Art. 013.SB

**Borsa per Kit calcio tennis
Art. 013.S**

Bag to carry soccer tennis
kit Art. 013.S



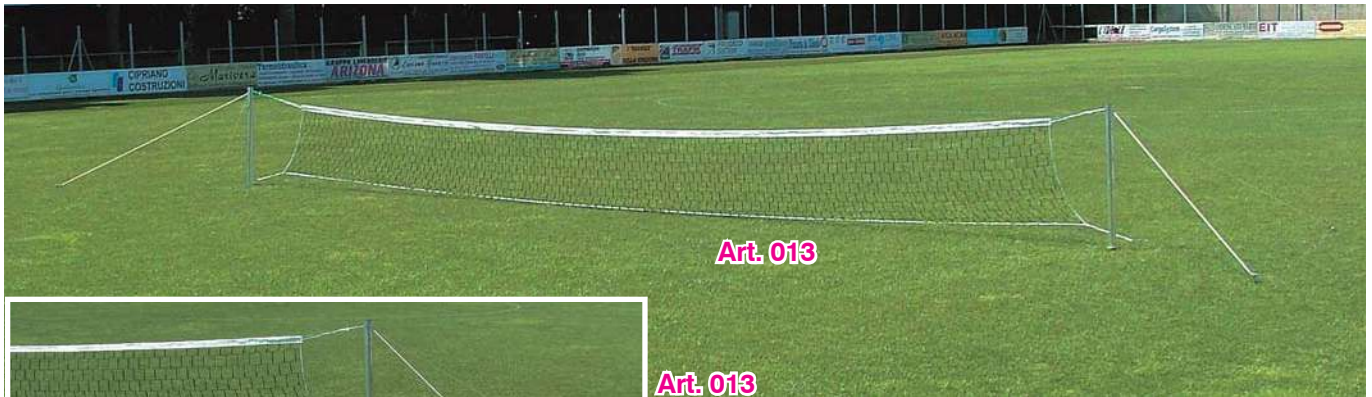

Art. 013



Art. 013

Kit Calcio Tennis pali in alluminio sezione mm. 60 completo di rete mt. 9,85 con tiranti, picchetti e nastro di delimitazione, utilizzabile solo su terreni naturali
 Soccer Tennis Kit aluminium poles 60 mm. with 9,85 meter net, tightening ropes, pegs and tape for bounds - for natural grass

pg.6



Art. 014

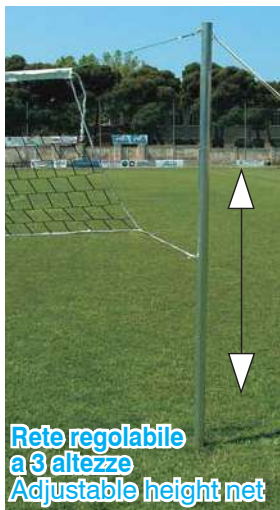

Rete regolabile a 3 altezze
Adjustable height net

Art. 014
Kit Calcio Tennis pali in alluminio sezione mm. 60 completo di rete mt. 9,85 regolabile a 3 altezze (cm. 110/170/230) con tiranti, picchetti e nastro di delimitazione, utilizzabile solo su terreni naturali
 Soccer Tennis Kit aluminium poles 60 mm. with 9,85 meter net adjustable at 3 different heights, tightening ropes, pegs and tape for bounds for natural grass

pg.6

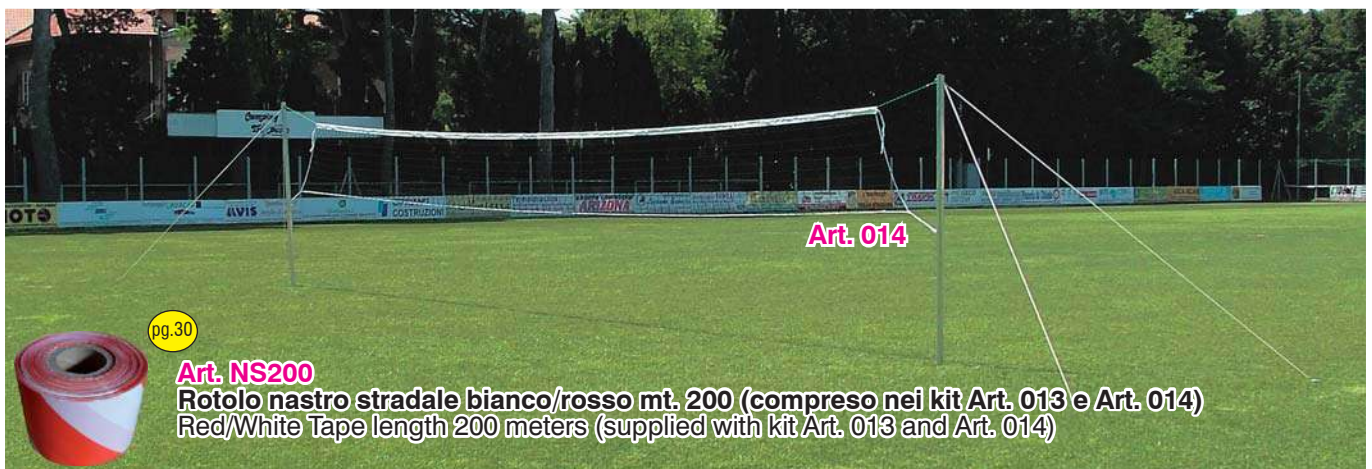

Art. 014

pg.30



Art. NS200
Rotolo nastro stradale bianco/rosso mt. 200 (compreso nei kit Art. 013 e Art. 014)
 Red/White Tape length 200 meters (supplied with kit Art. 013 and Art. 014)

FORCHE - Heading Trellises

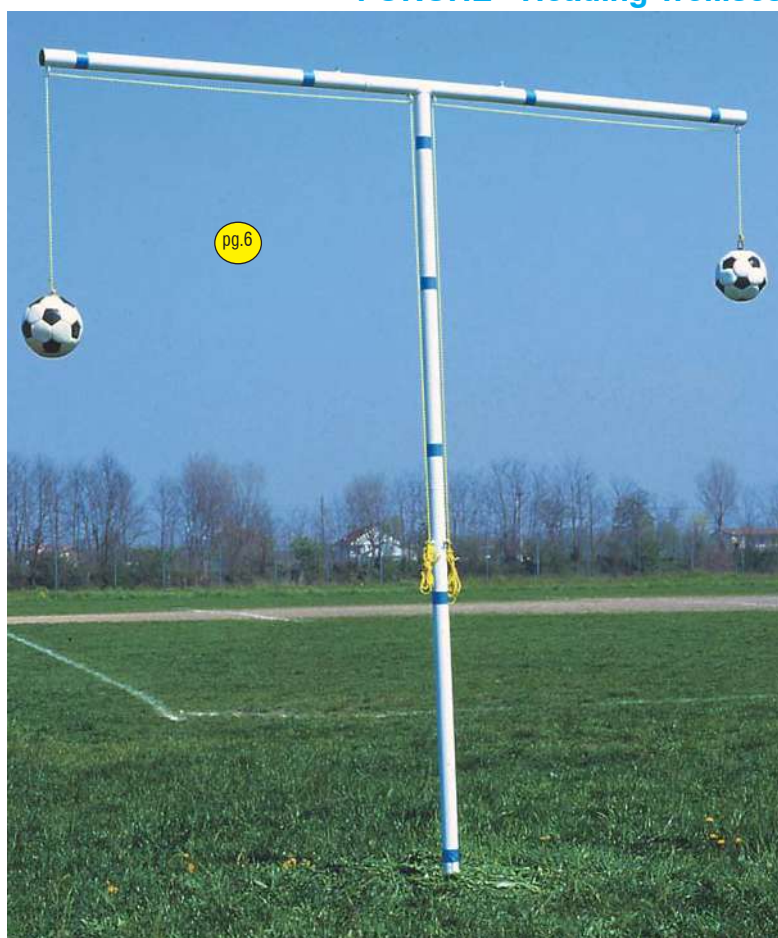

Art. F203
Forca doppia
in ferro verniciato
telescopica, smontabile
bussola inclusa
altezza da terra cm. 300
(palloni esclusi)

Double Heading Trellis
in painted iron
telescopic, dismountable,
underground socket included,
height 300 cm. off ground
(balls not included)



Art. FAC242
Forca singola in acciaio
verniciato metallizzato Ø mm. 80
su base in plastica riempibile
da lt. 105 con ruote
lunghezza braccio orizzontale cm. 150
(pallone escluso)
Single Heading Trellis in painted steel
pipe Ø 80 mm.
105 lt. plastic base on wheels
to be filled with water or sand
horizontal length 150 cm.
(ball not included)



Art. F243
Carrello con ruote pneumatiche per
spostamento Art. FAC242 su terreni erbosi
Trolley with pneumatic wheels for moving
Art. FAC242 on grass



Art. 038
Forca doppia
in alluminio
tubo sezione 60 mm.
altezza da terra cm.300
(palloni esclusi)
 Double Heading Trellis
 in aluminium
 pipe section 60 mm.
 300 cm. height off ground
 (balls not included)

Art. B038
Bussola per forca
Art. 038 (optional)
 Underground socket
 for Art. 038 (optional)



Art. ACTP40
Attrezzo per l'allenamento
al colpo di testa
applicabile a porte di qualsiasi tipo
per mezzo di fettucce elastiche,
in PVC Ø mm. 40
(pallone escluso)
 Header training tool
 to be easily applied to goals of any type
 by means of elastic tapes,
 PVC pipe Ø 40 mm.
 (ball not included)

pg.6



Art. 039.4
Pallone per
forca in pelle
 sintetica
 disponibile
 mis. 4
 Ball for
 Heading Trellis,
 in synthetic
 leather
 available
 size 4



Art. ULTVE5
Pallone per forca Trial n. 5 in gomma
 doppio strato gr. 420 Ø cm. 21,5
 Trial rubber Ball for Heading trellis
 size 5 double stratum

Art. ULTVE4
Pallone per forca Trial n. 4 in gomma
 doppio strato gr. 250 Ø cm. 20
 Trial rubber Ball for Heading trellis
 size 4 double stratum



Con questo attrezzo
è possibile verificare
 giornalmente i
 miglioramenti
 nell'elevazione
 degli atleti
 This instrument tests
 players' daily jump
 improvements



pg.10

Art. HJT Head Jump Tester - strumento polivalente di misurazione ed allenamento, permette la valutazione delle qualità muscolari degli arti inferiori, dell'elevazione dei giocatori, del loro modo di colpire la palla di testa e dell'ampiezza del tuffo del portiere
 Instrument that allows the training and measurement of jump ability of players and goalkeepers

ARCHI DI PRECISIONE - Precision passing arcs

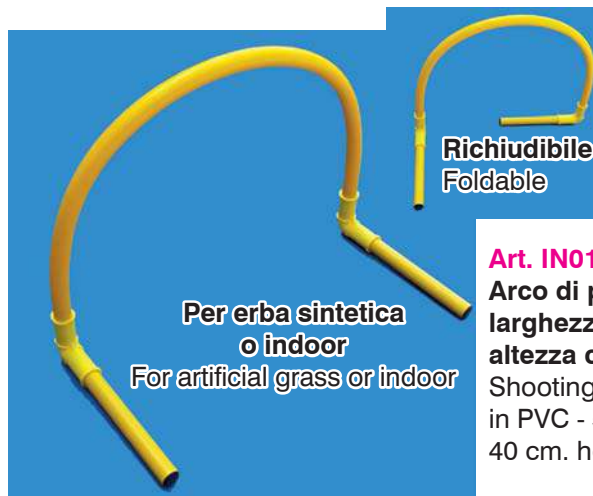

pg.6

Art. IN01
Arco di precisione in PVC
larghezza cm.50
altezza cm.40
Shooting/Passing Arc
in PVC - 50 cm. width
40 cm. height

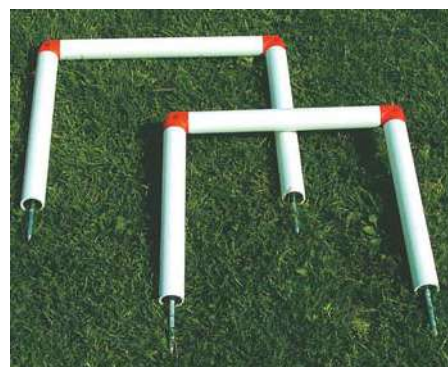

Art. 020 / 021 / 022
Arco di precisione in polipropilene
Ø 40 mm. cm. 45x45 / 40x40 / 35x35
Shooting/Passing Arc
in polypropylene Ø 40 mm.
dim. 45x45 / 40x40 / 35x35 cm.

pg.6



Art. A020 / A021 / A022
Arco di precisione
in alluminio Ø 32 mm.
cm. 45x45 / 40x40 / 35x35
Shooting/Passing Arc
in aluminium Ø 32 mm.
dim. 45x45 / 40x40 / 35x35 cm.

pg.6



BARRIERE SPECIALI - GK TRAINING

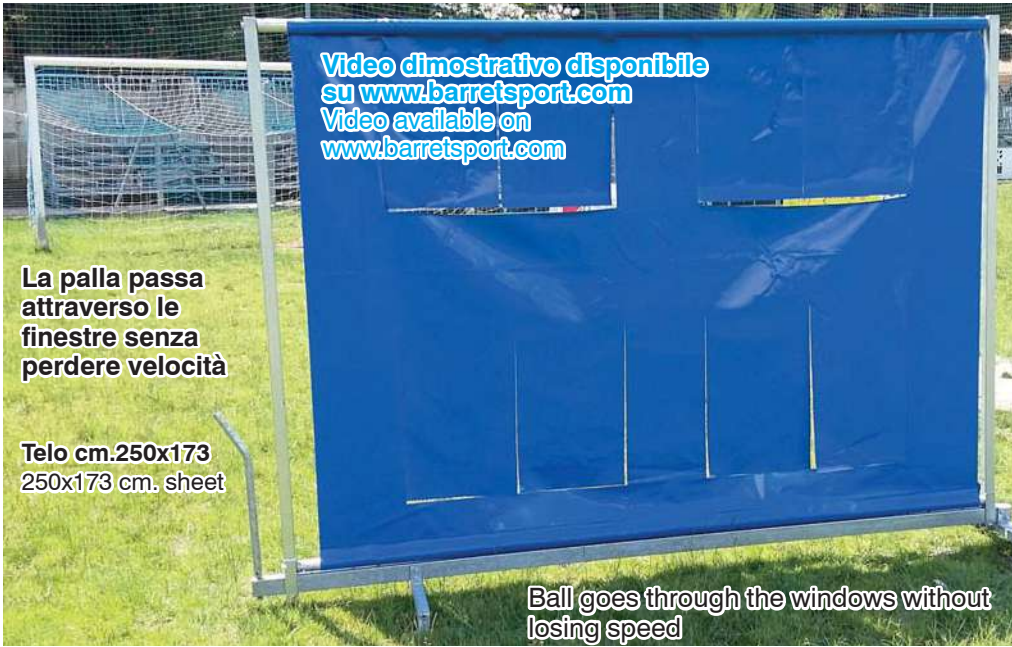

Art. 003WB
BARRIERA CON FINESTRE
 per l'allenamento ai calci di punizione e per il miglioramento dei tempi di reazione del portiere in caso di tiri improvvisi
kit completo
 WINDOW BARRIER for free kicks and Goalkeeper training to fast and sudden shots complete kit

pg.1

Art. 003WBS
STRUTTURA SUPERIORE
 barriera con finestre, applicabile al carrello porta sagome Art. 003
 Window Barrier UPPER PART to be fixed upon trolley Art. 003



Art. 003RX
BARRIERA FILTRANTE REFLEX kit completo
 REFLEX FILTERING BARRIER on wheels - complete kit

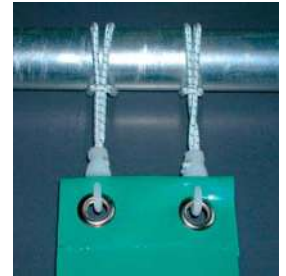

Nuovo sistema di fissaggio
 New more resistant elastics and hooks

pg.1

Art. 003RXS
STRUTTURA SUPERIORE barriera filtrante REFLEX, applicabile al carrello porta sagome Art. 003
 Reflex Filtering Barrier UPPER PART to be fixed upon trolley Art. 003



INNOVATIVO ATTREZZO FONDAMENTALE PER L'ALLENAMENTO DEI RIFLESSI DEL PORTIERE. LA PALLA (PRESSOCHÉ INVISIBILE PER IL PORTIERE AL MOMENTO DEL CALCIO) FILTRA ATTRAVERSO LE STRISCE ED ARRIVA IN PORTA ALL'IMPROVVISO ASSUMENDO TALVOLTA TRAIETTORIE IMPREVEDIBILI. ATTREZZO DA POSIZIONARE IN PROSSIMITÀ DELL'AREA PICCOLA
A revolutionary device for goalkeeper's reflex training. The goalkeeper hardly can see the ball until it passes through the stripes. The direction of the ball is often unpredictable! To be placed not too far from goalkeeper's area



L'ATTREZZO PUO' INOLTRE ESSERE UTILIZZATO COME UNA COMUNE BARRIERA PER L'ALLENAMENTO DEI CALCI DI PUNIZIONE
It is also very useful for free kick practising for both kicker and goalkeeper!



MURI - TELAI CON RETE - Rebounders - Iron frames with net



Vista frontale
Front view



Vista laterale
Side view

Video dimostrativo
disponibile
su www.barretsport.com
Video available on
www.barretsport.com

Art. 5011

**Muro per allenamento portieri in vetroresina
montato su telaio con 4 ruote**
Fiberglass Goalkeeper Rebounder
mounted on frame with
4 wheels

pg.6

Dimensioni:
altezza cm.200
larghezza cm.130
profondità cm.80
peso Kg.100

Dimensions:
height 200 cm.
width 130 cm.
depth 80 cm.
weight 100 Kg.

**Calciando o lanciando la palla
verso il muro, essa assumerà
traiettorie di rimbalzo
imprevedibili favorendo
l'allenamento dei riflessi
del portiere**

By kicking or throwing the ball
against the wall it will rebound in
different directions,
testing and training GK's reflexes



Vista posteriore
Back view

**Zavorra
in cemento
inclusa**
Concrete
ballast
included

**Consente l'allenamento con
o senza il preparatore atletico**
Goalkeeper can exercise
by himself as well



**Con superficie superiore a semisfere
e superficie inferiore piana**
Upper side with hemispheres
and flat lower side





pg.6



Art. 5012SC
Muro per allenamento portieri in vetroresina cm. 200x130
installato su carrello in acciaio zincato con ruote Art. NCP3S
 Fiberglass Goalkeeper rebounder 200x130 cm. installed on a
 galvanized steel trolley with wheels Art. NCP3S

pg.6

Art. KMC3S
Kit superiore muro allenamento
portieri per adattamento a carrello
Art. NCP3S oppure Art. 003
 Rebounder kit upper part to be fixed
 upon trolley Art. NCP3S or Art. 003

Rimuovendo il pannello in vetroresina
ed eventualmente il telaio di sostegno,
si può utilizzare il carrello porta 3
sagome Art. NCP3S

By removing the fiberglass panel and the
 support frame, you can use the trolley for
 carrying 3 mannequins Art. NCP3S



Art. PVLSC
Pannello in vetroresina con superficie superiore a semisfere e superficie inferiore liscia, munito di ganci e
staffa per ancoraggio - dimensioni cm. 200x130
Può essere acquistato separatamente ed installato facilmente sulla Barriera Filtrante Reflex Art. 003RX
oppure sulla Barriera con Finestre Art. 003WB
 Fiberglass panel with upper hemisphere surface and lower smooth surface, equipped with hooks and anchor
 bracket - size 200x130 cm. It can be purchased separately and easily installed both on the Reflex Filtering Barrier
 Art. 003RX and on the Window Barrier Art. 003WB



Dimensioni:
m. 1,3 larghezza x m. 1,1 altezza
ciascuna faccia
peso Kg. 50
Dimensions:
1,3 m. width x 1,1 m. height
every side
weight 50 Kg.

● pg.7

Art. R1150

Muro per allenamento giocatori e portieri a 2 facce di cui una piana ad inclinazione regolabile ed una con emisfere, interamente in vetroresina montato su telaio con 4 ruote
2 side Fiberglass Players and Goalkeepers' Rebounder mounted on frame with 4 wheels
the flat side can be inclined, the fixed side with hemispheres



Attraverso l'utilizzo della parete ad inclinazione regolabile è possibile determinare traiettorie di risposta della palla verso l'alto al fine di sollecitare il tiro al volo, il colpo di testa ed il controllo di palla
Calciando o lanciando la palla verso la parete con emisfere, essa assumerà traiettorie di rimbalzo imprevedibili favorendo l'allenamento dei riflessi del portiere e dei giocatori
Thanks to the adjustable inclination of the flat side you can get an upward ball rebound and train acrobatic shooting, headers and ball control
Through the use of the side with hemispheres you can get unpredictable trajectories for training goalkeepers' reflexes and players' reactivity



Art. 5050

Muro per allenamento giocatori a 2 facce di cui una ad inclinazione regolabile, interamente in vetroresina montato su telaio con 4 ruote
 2 side Fiberglass Players' Rebounder mounted on frame with 4 wheels
 one side can be inclined

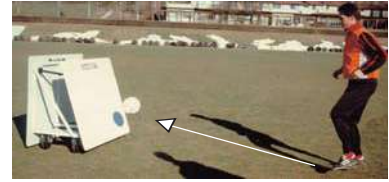

Kg. 50

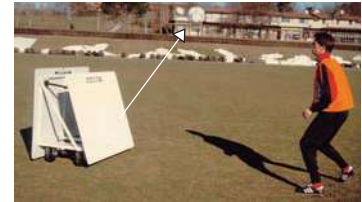

● pg.7



Dimensioni:
 m. 1,3 larghezza x m. 1,1 altezza
 ciascuna faccia
peso Kg. 50
 Dimensions:
 1,3 m. width x 1,1 m. height
 every side
 weight 50 Kg.

Attraverso l'utilizzo della parete ad inclinazione regolabile è possibile determinare traiettorie di risposta della palla verso l'alto al fine di sollecitare il tiro al volo, il colpo di testa ed il controllo di palla
 Thanks to the adjustable inclination you can get an upward ball rebound and train acrobatic shooting, headers and ball control



Kg. 50

● pg.7



Art. 5010

Muro per allenamento giocatori a 3 facce in vetroresina montato su telaio con 3 ruote
 3 side Fiberglass Players' Rebounder mounted on frame with 3 wheels
 Dimensions: 1,3 m. width x 1,1 m. height
 every side
 weight 50 Kg.



Art. MP501N

**Muro prismatico in vetroresina a 3 facce piane di dimensioni
cm.107x140 - cm.107x120 - cm.107x108 - peso Kg.48 - con asole per il trasporto
utilizzabile contemporaneamente da 2 lati ed in 4 diverse posizioni**

3 side Fiberglass Players' Rebounder with side dimensions
107x140 cm. - 107x120 cm. - 107x108 cm. weight 48 Kg. with slots for transport
****allows 4 different training positions on both sides simultaneously****

pg.7



Permette di ottenere la più ampia varietà di rimbalzi e traiettorie, utili per il miglioramento del controllo di palla, del passaggio, del tiro al volo e del colpo di testa

1

Posizione "in piedi" con 3 facce perpendicolari al terreno di gioco
Standing position with all sides perpendicular to the ground



2

Posizione con base a terra cm.107x108
Allenamento con superfici di rimbalzo ad inclinazione alta e medio-alta
Position with 107x108 cm. base
Training with high and medium inclination rebounding sides



Allows the widest variety of rebounds in order to improve ball control, passing and shooting



3

Posizione con base a terra cm.107x120
Allenamento con superfici di rimbalzo ad inclinazione alta e bassa
Position with 107x120 cm. base
Training with high and low inclination rebounding sides



4

Posizione con base a terra cm.107x140
Allenamento con superfici di rimbalzo ad inclinazione medio-bassa e bassa
Position with 107x140 cm. base
Training with medium-low and low inclination rebounding sides

Rinforzo interno per l'ottimizzazione del rimbalzo
Internal reinforcement for rebound improvement

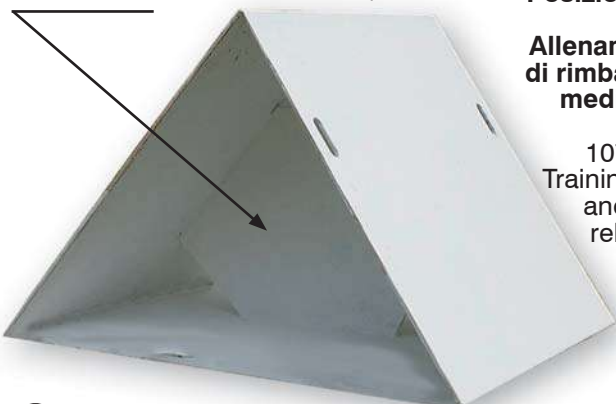

Art. PLRB16

Muro prismatico PROFESSIONALE
in vetroresina a 3 facce piane
lunghezza cm.130 - altezza massima cm.65
con asole per il trasporto - peso kg.18
****utilizzabile contemporaneamente da 2 lati**
ed in 3 diverse posizioni**

PROFESSIONAL 3 side Fiberglass Players' Rebounder width 130 cm. - maximum height 65 cm. with slots for transport - 18 kg. weight
****allows 3 different training positions on both sides simultaneously****

pg.7

Art. PLRB23

Muro prismatico in legno multistrato marino
a 3 facce piane lunghezza cm.122
altezza massima cm.65
con asole per il trasporto - peso kg.20
****utilizzabile contemporaneamente da 2 lati**
ed in 3 diverse posizioni**

3 side marine plywood Players' Rebounder width 122 cm. - maximum height 65 cm. with slots for transport - 20 kg. weight
****allows 3 different training positions on both sides simultaneously****

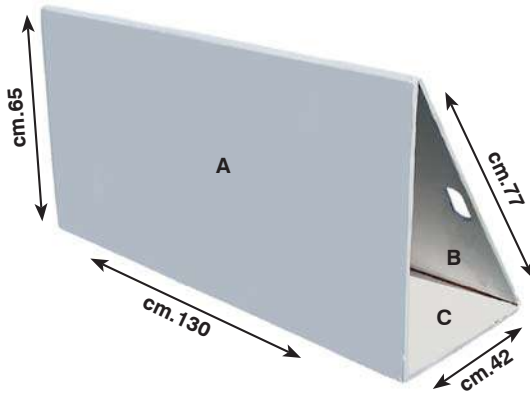

1

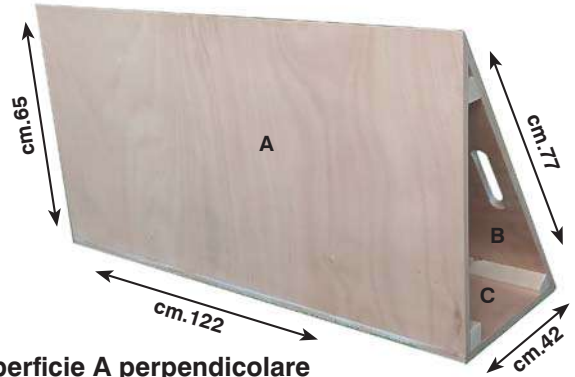

Posizione con superficie A perpendicolare al terreno e superficie B molto inclinata
 Position with 90 degrees A side and high inclination B side

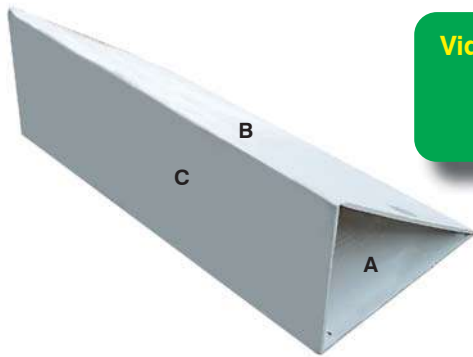

Video dimostrativo disponibile su www.barretsport.com
 Video available on www.barretsport.com

2

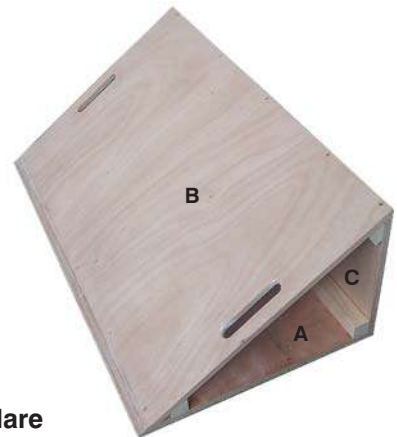

Posizione con superficie C perpendicolare al terreno e superficie B inclinata
 Position with 90 degrees C side and low inclination B side

Prodotto professionale in vetroresina con rinforzo interno per l'ottimizzazione del rimbalzo
 Professional in fiberglass with internal reinforcement for rebound improvement

Si consiglia di utilizzare una zavorra all'interno dell'attrezzo per conferire maggiore stabilità
 It is recommended to place a weight inside for great stability

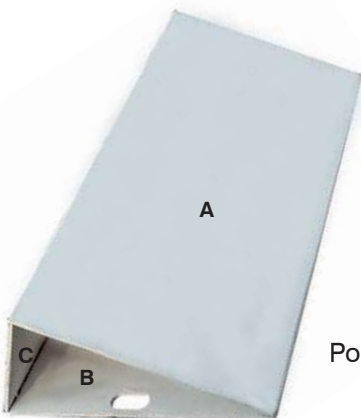

3

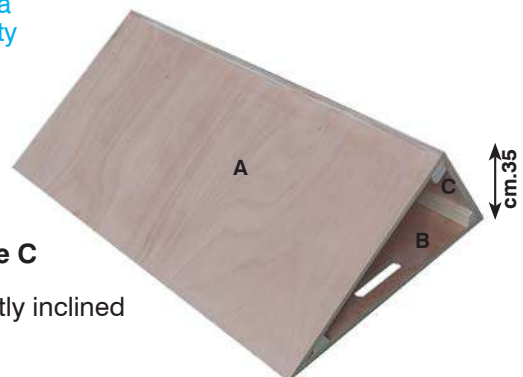

Posizione con superfici A e C a diverse inclinazioni
 Position with A and C sides differently inclined

Permettono di ottenere la più ampia varietà di rimbalzi e traiettorie, utili per il miglioramento del controllo di palla, del passaggio, del tiro al volo e del colpo di testa

They allow the widest variety of rebounds in order to improve ball control, passing and shooting

Art. PAR180
PLANCHE À REBONDS
Parete rimbalzante realizzata in PE
(all'esterno) e PU (all'interno)
ideale per l'effettuazione
di esercizi individuali e di
gruppo volti al miglioramento
della coordinazione motoria,
del controllo di palla,
del passaggio e del tiro
Rebound board made of PE (outside)
and PU (inside)
very useful for individual and
group exercises aimed to improve
coordination, ball control,
passing and shooting

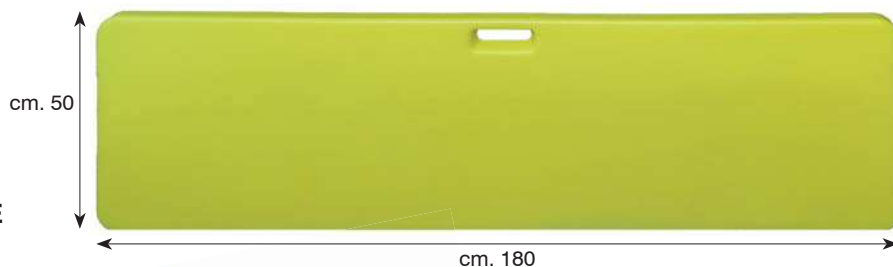

Dimensioni: lunghezza cm. 180
altezza cm. 50
profondità cm. 34
peso kg. 23

Dimensions: length 180 cm.
height 50 cm.
depth 34 cm.
weight 23 kg.

● pg.7

La distribuzione dei volumi appesantiti consente ottima stabilità e perfetto bilanciamento anche negli impatti più potenti.
Tuttavia, se lo si ritiene necessario, è possibile aggiungere peso mediante sabbia o acqua
The distribution of the weighted volumes allows excellent stability and perfect balance even with the most powerful shots.
However, if necessary, sand or water can be added



● pg.7

Art. TM002
Muro triangolare in legno multistrato marino con asole
per il trasporto, dimensioni lato cm.150x50
Attraverso l'uso in posizione verticale è possibile
determinare traiettorie di risposta della palla verso
l'alto al fine di sollecitare il tiro a volo, il colpo di testa
e lo stop
Triangular rebounder made of marine plywood with slots
for transport, side size 150x50 cm.
By placing it in vertical position you will receive an upward
ball rebound to train acrobatic shooting, header and ball
control

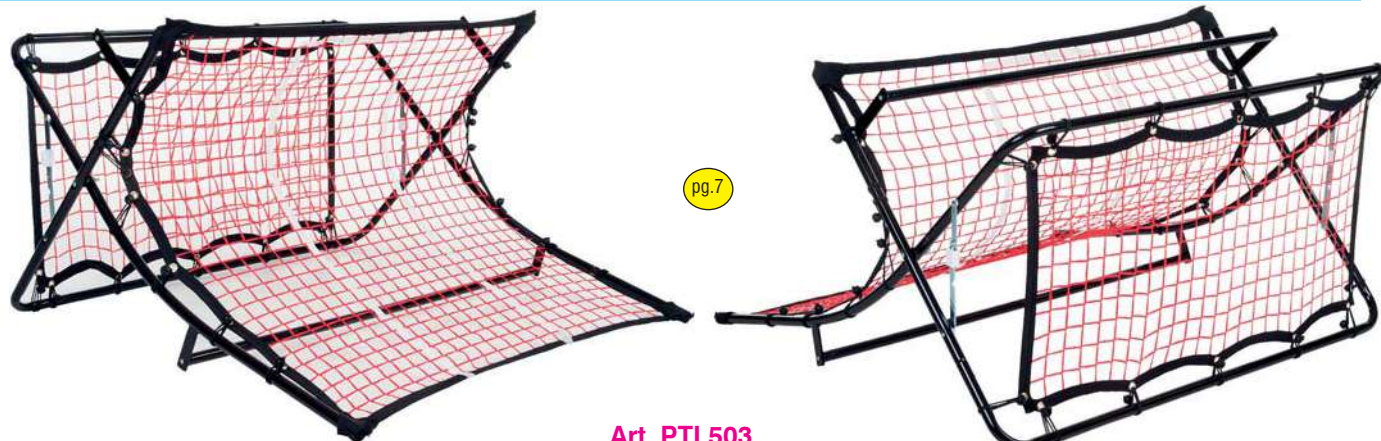

● pg.7

Art. PTI.503
Telaio con rete in acciaio verniciato, bifacciale ricurvo su un lato - inclinazione regolabile dim. cm. 111x105x63
2 face adjustable inclination iron frame with net for goalkeepers and players size 111x105x63 cm.



Art. SCVR16

Disco in vetroresina con maniglie per l'allenamento della reattività del portiere sulle deviazioni da tiro o colpo di testa ravvicinato diametro cm.47 peso kg.2
Fiberglass Discus with handles for close shot and deflection GK training diameter 47 cm. weight 2 kg.

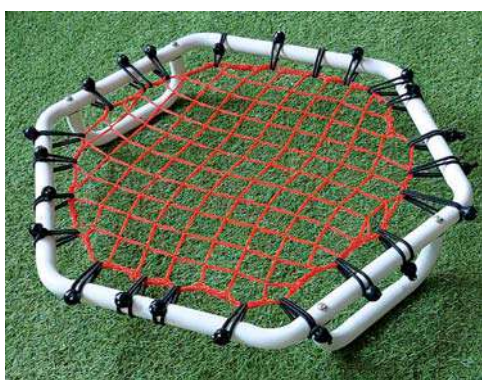

Art. PTI.5858

Telaio con rete esagonale in metallo verniciato dim. cm.65x58 con maniglie impugnabili dal preparatore. Consente la simulazione di colpi di testa e tiri acrobatici per un allenamento alternativo del portiere
Hexagonal metal frame with net size 65x58 cm. with handles for trainer to simulate headers and acrobatic shooting trajectories for new GK exercises

pg.7



Art. 5030.T

Telaio con rete in alluminio dim. cm.90x70 ad inclinazione regolabile con maniglie impugnabili dal preparatore. Consente la simulazione di colpi di testa e tiri acrobatici per un allenamento alternativo del portiere
Aluminium frame with net size 90x70 cm. adjustable inclination with handles for trainer to simulate headers and acrobatic shooting trajectories for new GK exercises



New!



Art. RBA75

Telaio con rete bifacciale dim. cm.75x75 in ferro verniciato ad inclinazione regolabile - peso kg.5,3
Double side painted iron frame with net size 75x75 cm. adjustable inclination - 5,3 kg.



Art. 5030

Telaio con rete cm. 130 x 130 in ferro verniciato ad inclinazione regolabile
Painted iron frame with net, dimensions 130 x 130 cm. adjustable inclination



Art. 503.BF

Telaio con rete in ferro verniciato, bifacciale a doppia inclinazione, altezza cm.150 larghezza cm.100 con picchetti per fissaggio a terra, per allenamento portieri e giocatori
Iron frame with net, in painted iron 2 sides double inclination height 150 cm. width 100 cm. with anchoring hooks for goalkeepers and players

pg.7

Art. 5035G Telaio con rete **cm.105 x 105** in ferro cromato ad inclinazione regolabile, per allenamento portieri e giocatori
Iron frame with net in chromed iron dimensions 105 x 105 cm. adjustable inclination for goalkeepers and players

Prodotto professionale in ferro cromato
Professional in chromed iron



Prodotto professionale in ferro zincato
Professional in galvanized iron

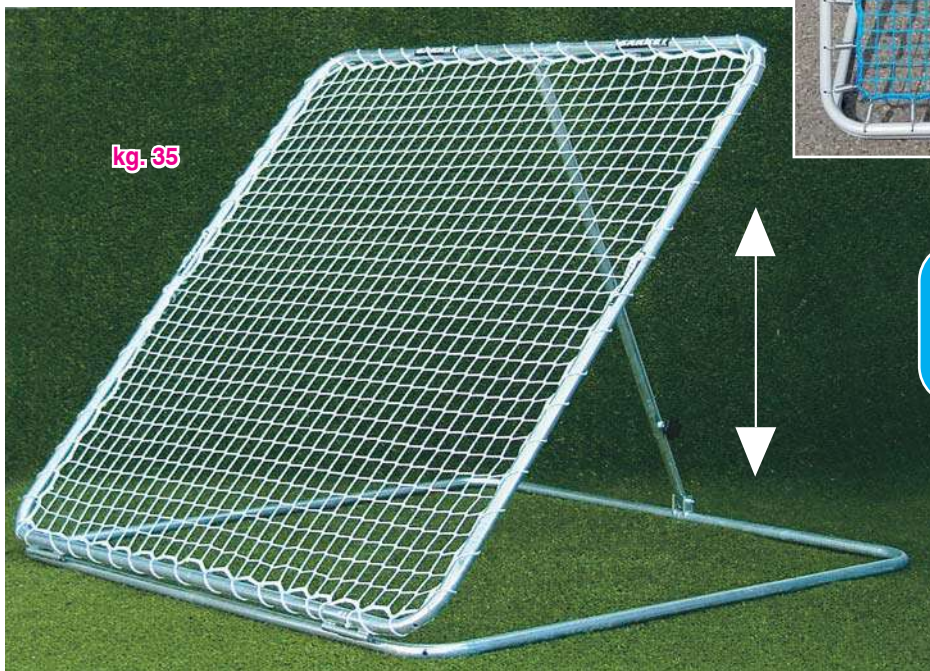

Art. 5040

Telaio con rete cm. 140 x 140 in ferro zincato ad inclinazione regolabile, per allenamento portieri e giocatori
Iron frame with net in galvanized iron dimensions 140 x 140 cm. adjustable inclination for goalkeepers and players

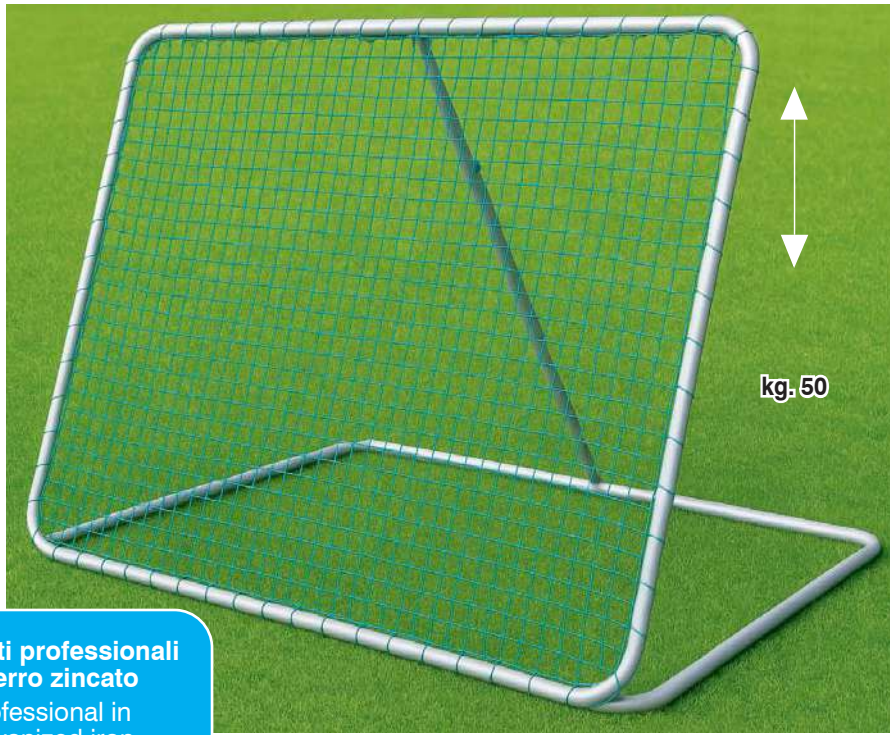

Art. 50.220
Telaio con rete
cm. 220 x 180
in ferro zincato
ad inclinazione regolabile,
per allenamento
portieri e giocatori
 Iron frame with net in
 galvanized iron dimensions
 220 x 180 cm.
 adjustable inclination
 for goalkeepers and players

kg. 50



Art. ST221
Set 4 ruote con staffa per un
agevole trasporto del telaio
Art. 50.220 (optional)
 Set of 4 wheels with bracket
 for Art. 50.220 (optional)

Prodotti professionali
in ferro zincato
 Professional in
 galvanized iron



Art. 5041
Telaio con rete cm. 315 x 230
in ferro zincato ad inclinazione regolabile,
per allenamento portieri e giocatori
 Iron frame with net, in galvanized iron
 dimensions 315 x 230 cm.
 adjustable inclination
 for goalkeepers and players

kg. 75

pg.7



Art. ST441
Set 4 ruote con staffa per un agevole
trasporto del telaio Art. 5041 (optional)
 Set of 4 wheels with bracket for Art. 5041 (optional)



Video dimostrativo disponibile su www.barretsport.com
 Video available on www.barretsport.com

Art. DT01
Deviatore di traiettoria in alluminio con cerniere e piedini di stabilità. Coadiuvava l'allenamento quotidiano del portiere ed il suo eventuale recupero post-traumatico
 Shot deviator in aluminium with hinges and stability pegs - very useful to improve GK reactivity and to accelerate injury recovery

Brevettato Patented

pg.6

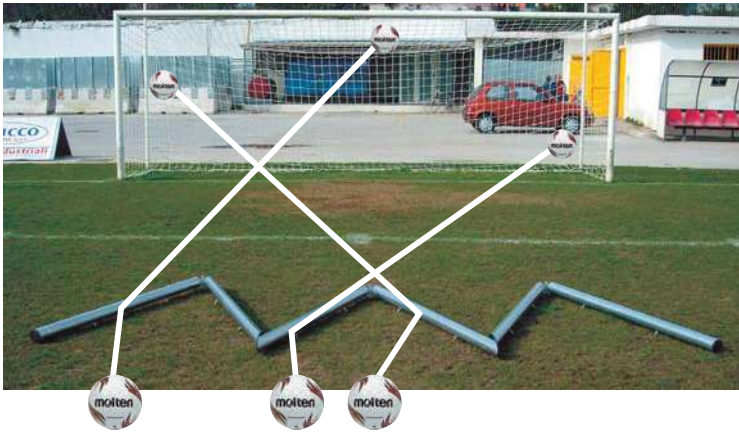

Borsa per il trasporto inclusa
 Bag included

Si consiglia di inumidire l'erba di fronte all'attrezzo per incrementare la velocità della palla calciata rasoterra prima dell'impatto con il deviatore
 We recommend to wet the grass in front of the training device in order to let the ball hit the deviator at a higher speed



Art. BP63
BALL PLAYNING Modello Mundial - telo in PVC con rilievi gonfiabili e riempiibili con acqua per l'allenamento dei riflessi del portiere, metri 6x2,5 completo di borsa, pompa per la gonfiatura e sacca per il trasporto dell'acqua
 Ball Playning Mundial for GK training in PVC size 6x2,5 meters with air and water bubbles, complete with pump and bag

pg.6

Video dimostrativo disponibile su www.barretsport.com
 Video available on www.barretsport.com



Bagna il Ball Playning prima dell'uso per incrementare la velocità della palla!
 Always wet your Ball Playning to increase ball speed!





Art. CGG24

Cuscino gonfiabile con maniglie cm.70x50 per contrasto alle uscite alte del portiere
Inflatable cushion 70x50 cm. with handles for football goalkeeper exit training

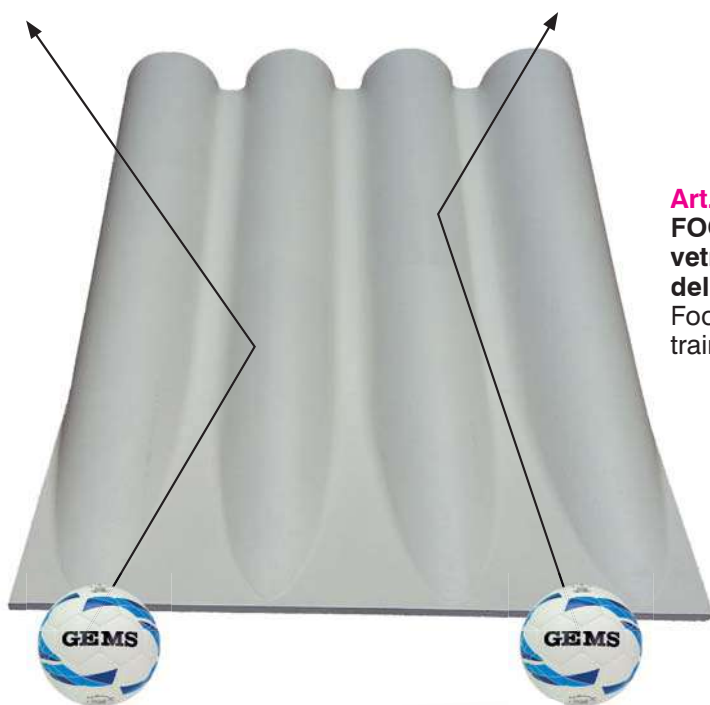

Art. FRM16
FOOTBALL RAMP - attrezzo in vetroresina per l'allenamento dei riflessi del portiere sui tiri ravvicinati e deviati
Football Ramp - fiberglass deviator for GK training to close highly deflected shots

pg.7

Bagna il Football Ramp prima dell'uso per incrementare la velocità della palla!

Always wet your Football Ramp to increase ball speed!



Dimensioni: cm.150x110 ad inclinazione regolabile per mezzo di due piedi telescopici
Dimensions: 150x110 cm. adjustable inclination by means of two telescopic feet

Video dimostrativo disponibile su www.barretsport.com
Video available on www.barretsport.com

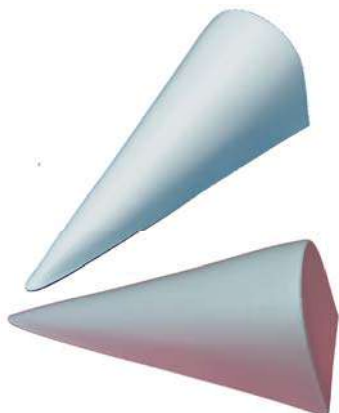

Art. BDV15
Cuspide in vetroresina appesantita con cemento, dimensioni cm.56x21x21h per l'allenamento dei riflessi del portiere

Fiberglass cusp with concrete filling
dimensions 56x21xh21 cm. for GK training

Posizionando una serie di cuspidi nell'area piccola si ottengono deviazioni della palla improvvise, utili per l'allenamento dei riflessi e della reattività del portiere

Train goalkeeper's reactivity to sudden and close deflections by placing a number of cusps near the GK's area

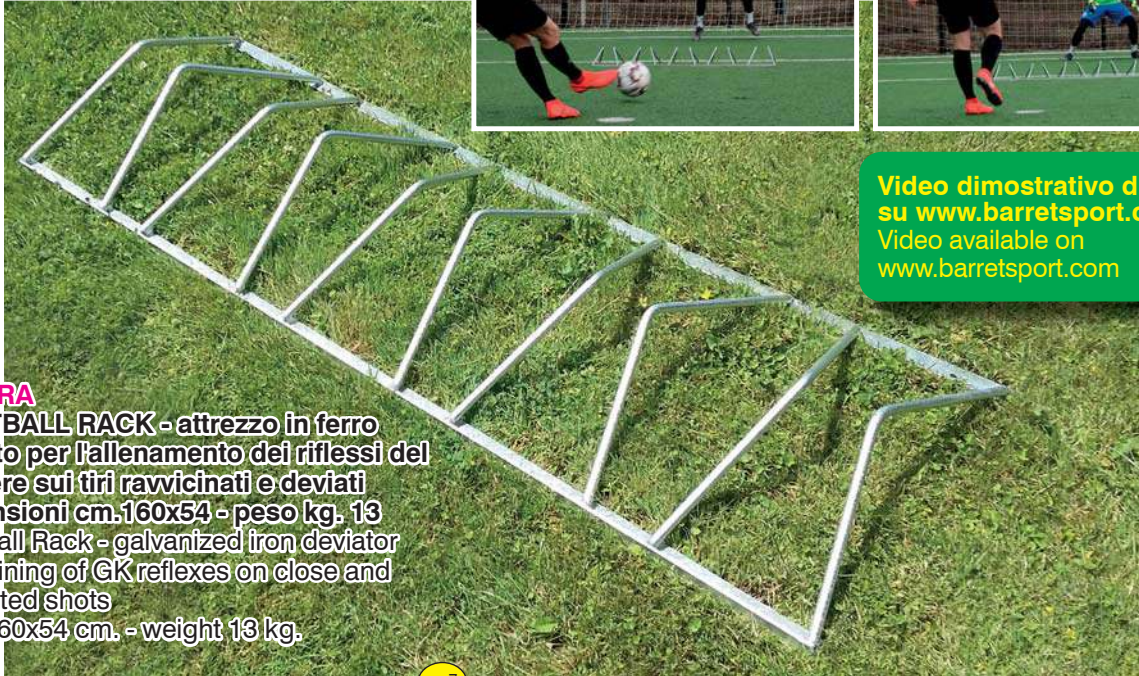

Video dimostrativo disponibile su www.barretsport.com
 Video available on www.barretsport.com

Art. FRA
FOOTBALL RACK - attrezzo in ferro zincato per l'allenamento dei riflessi del portiere sui tiri ravvicinati e deviati
 dimensioni cm.160x54 - peso kg. 13
 Football Rack - galvanized iron deviator for training of GK reflexes on close and deflected shots
 size 160x54 cm. - weight 13 kg.

pg.7



Video dimostrativo disponibile su www.barretsport.com
 Video available on www.barretsport.com



Art. FW18
FOOTBALL WAVE - attrezzo in policarbonato per l'allenamento dei riflessi del portiere sui tiri ravvicinati e deviati
 dimensioni cm. 90x60 - peso kg. 5
 Football Wave - polycarbonate deviator for training of GK reflexes on close and deflected shots
 size 90x60 cm. - weight 5 kg.

Bagna il Football Wave prima dell'uso per incrementare la velocità della palla!
 Always wet your Football Wave to increase ball speed!

Inclinazione regolabile per mezzo di due piedi telescopici
 Adjustable inclination by means of two telescopic feet

Più Football Waves possono essere posizionati contemporaneamente sul terreno per ottenere effetti imprevedibili
 You can place more than one Football Wave on the pitch to get unpredictable deflections



PROPRIOCEZIONE - Equilibrium training



Art. 168PC

Art. 168PC
Tavoletta propriocettiva in plastica su emisfera, Ø cm. 41 regolabile in altezza
Plastic Equilibrium Board with hemisphere bottom side Ø 41 cm. adjustable height



Art. 168PC

pg.7

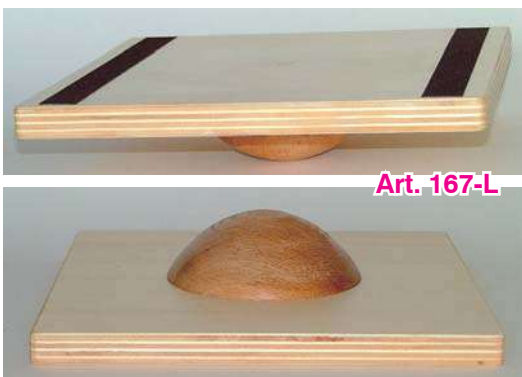

Art. 167-L

Art. 167-L Tavoletta propriocettiva in legno su emisfera, base di appoggio cm. 30x30
Wooden Equilibrium Board with hemisphere bottom side, base 30x30 cm.



Art. IS441
Tavoletta propriocettiva in legno su emisfera, con rivestimento antiscivolo Ø cm. 40
Wooden Equilibrium Board with hemisphere bottom side, Ø 40 cm. base with anti-skid surface



Art. 169-R

Art. 169-R Tavoletta propriocettiva in legno su semiluna, base di appoggio cm.60x40 con rivestimento in gomma antiscivolo
Wooden Equilibrium Board, with half moon bottom side, base dimensions cm.60x40 with anti-skid surface



Art. 167-T

Art. 167-T Tavoletta propriocettiva in legno su emisfera, Ø base di appoggio cm. 60 con rivestimento in gomma antiscivolo
Wooden Equilibrium Board with hemisphere bottom side, base Ø 60 cm. with anti-skid surface

pg.8



Art. 169-V Tavoletta propriocettiva in vetroresina su semiluna, base di appoggio cm.60x40
Fiberglass Equilibrium Board, with half moon bottom side, base dimensions 60x40 cm.



Art. 167-V Tavoletta propriocettiva in vetroresina su emisfera, Ø base di appoggio cm. 50
Fiberglass Equilibrium Board with hemisphere bottom side, base Ø 50 cm.



Art. MH9T / MH16T Semisfera gonfiabile Trial per riabilitazione e stimolazione propriocettiva diam. cm. 9 o cm. 16
Inflatable hemisphere for rehabilitation Ø 9 or 16 cm.



Art. FTN-DB
Cuscino gonfiabile puntinato Ø cm 32,5
Inflatable cylinder for rehabilitation Ø 32,5 cm.



Art. FY8911
Cuscino gonfiabile puntinato Ø cm 39
Inflatable cylinder for rehabilitation Ø 39 cm.



pg.8

Special Price



Art. C1
Pedana Cilindrica gonfiabile Trial Skimmy per riabilitazione e stimolazione propriocettiva dim. cm.32,5x6
Inflatable cylinder for rehabilitation dim. 32,5x6 cm.

Special Price



Art. C2
Pedana Cilindrica gonfiabile Trial Super Skimmy per riabilitazione e stimolazione propriocettiva, dim. cm.40x9
Inflatable cylinder for rehabilitation dim. 40x9 cm.



Resistenti ai tacchetti
Stud proof

Special Price



Art. C3
Pedana Trial Super Skimmy Professional con spalla rinforzata per riabilitazione e stimolazione propriocettiva, gonfiabile cm.40x9
Inflatable cylinder 40x9 cm. reinforced on sides





Art. C11
Pedana Rotante 1
 dim. cm 32,5x6
 kg 2,8
 (inclusa pompetta
 per la gonfiatura)
 Rotatory disk 1
 pump included



Art. C22
Pedana Rotante 2
 dim. cm 40x10
 kg 4
 (inclusa pompetta
 per la gonfiatura)
 Rotatory disk 2
 pump included



Le Pedane Rotanti Trial, grazie al particolare meccanismo rotante, consentono di creare un'infinita varietà di esercizi basati su diverse posizioni di appoggio e modalità di movimento, utili a stimolare contemporaneamente il sistema vestibolare e quello visivo sensoriale, agendo quindi su tutti i sistemi di controllo del movimento sia a livello nervoso centrale che su quello spinale medio e periferico

Rotatory Proprioceptive Disks Trial, given the particular rotating mechanism, allow a great variety of exercises based on different positions and motions, useful to simultaneously stimulate the vestibular and the sensory visual systems at both central and spinal/peripheral nervous levels

pg.8

Art. C4
Rebound Disk - diametro cm.40
altezza cm.4 - Kg.1,2 colore rosso
 40 cm. diameter - 4 cm. thick - 1,2 Kg.

Special Price

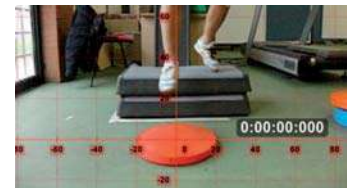

Rebound Disk Trial è una nuova pedana ideale per allenare contemporaneamente la forza muscolare e la propriocezione. È adatta sia all'uso indoor che outdoor, anche con scarpe tecniche munite di tacchetti. In particolare, con Rebound Disk è possibile sfruttare l'altezza per effettuare esercizi combinati pliometrici (cadute ed ammortizzamento con e senza rimbalzo) e propriocettivi, consentendo all'utente un'esperienza coordinativa e di potenziamento neuromuscolare notevole.

Il salto, così come la corsa, è un elemento fondamentale in moltissimi sport come calcio, pallamano, beach-handball, basket, volley, e Rebound Disk è particolarmente allenante per il salto con arresto e cambio di direzione

Rebound Disk Trial is a new tool ideal to simultaneously train muscle strength and proprioception.

It's suitable both for indoor and outdoor utilization, even with technical shoes (with studs).

In particular, with Rebound Disk it's possible to exploit one's height for plyometric exercises (fall and dampen with or without rebound) and for proprioceptive ones, and the user is enabled to experience a remarkable coordination and neuromuscular strengthening. Jumping, as well as running, is a basic element in many sports such as soccer, handball, beach-handball, basketball, volleyball, and Rebound Disk is very effective in training jump with stop and direction changes

**Art. T1 Medusa Trial - struttura instabile base Ø cm. 45
altezza cm. 23 per riabilitazione e stimolazione
dell'equilibrio, in gomma doppio strato
massima instabilità**

Medusa for rehabilitation
and equilibrium training
double stratum rubber
base Ø 45 cm.
height 23 cm.

**Resistente
ai tacchetti
Stud proof**

pg.8



**Special
Price**

**Resistente ai
tacchetti
Stud proof**

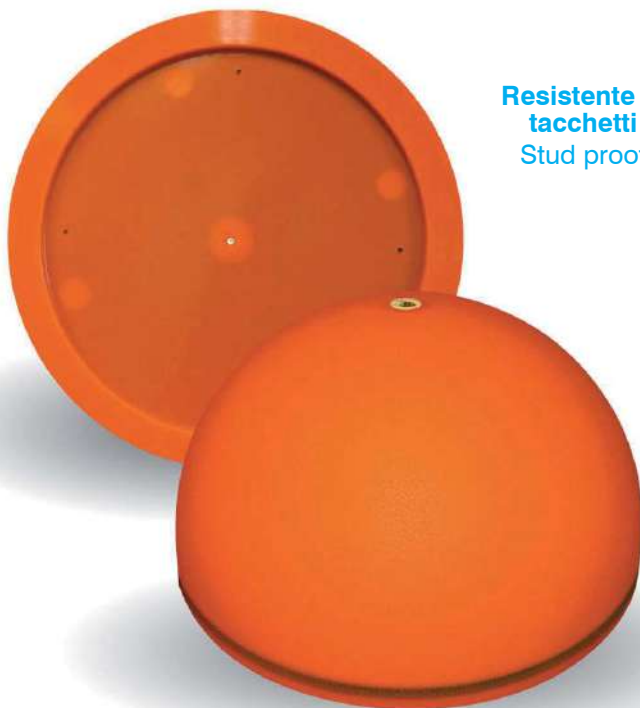

Art. T1.1

**Medusa Trial
base Ø cm.45
altezza cm. 23
con piatto rigido
sul fondo
per conferire
maggiore stabilità**

Medusa base Ø 45 cm.
height 23 cm.
with rigid bottom for better
stability

pg.8

**Special
Price**

**Resistente ai
tacchetti
Stud proof**



pg.8



Art. T3

**Pedana instabile
con base inferiore
antiscivolo Ø cm. 55
altezza cm. 15
studiata per campi sintetici,
specifica per i più giovani**

Unstable platform with
anti-skid bottom
base Ø 55 cm.
height 15 cm.
ideal for artificial grass
and young players

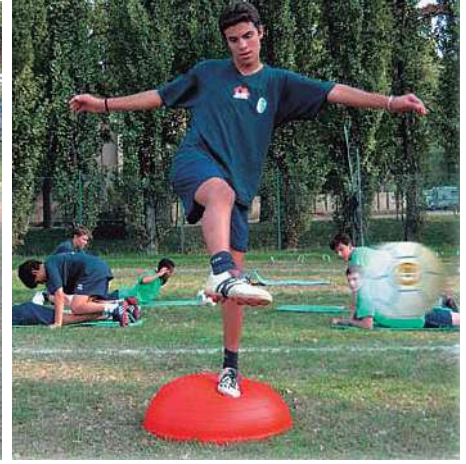
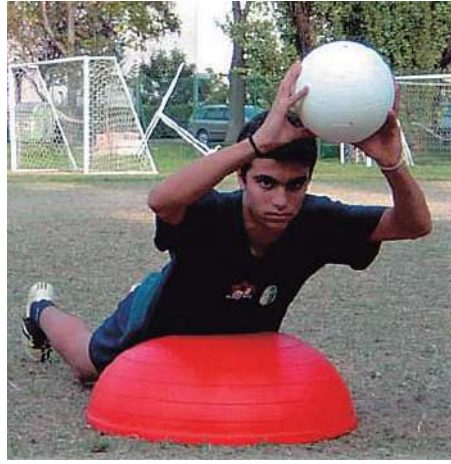

pg.8

Resistente ai tacchetti
Stud proof

Special Price



Art. T2 Tartaruga Evo Trial - struttura instabile base Ø cm. 65 altezza cm. 24 per riabilitazione e stimolazione dell'equilibrio, in gomma doppio strato
Tartaruga Evo double stratum rubber base Ø 65 cm. height 24 cm. for rehabilitation and equilibrium training



Art. AHF-170
Pedana BOSU Ø cm.63 - h. cm.22
ideale per fitness, yoga, pilates
Bosu platform Ø 63 cm. - h. 22 cm.
ideal for fitness, yoga, pilates

Art. BOS
Pedana BOSU Ø cm.59 - h. cm.26
ideale per fitness, yoga, pilates
completa di pompa
Bosu platform Ø 59 cm. - h. 26 cm.
ideal for fitness, yoga, pilates
with pump



pg.8



Art. 995212 SOMBRERO

Tavoletta per ginnastica e riabilitazione che combina l'instabilità dell'imbottitura in gommapiuma sul piano di appoggio in legno con le proprietà di una semisfera gonfiabile (ad esaurimento scorte)

Wooden Equilibrium Board with foam rubber on top and inflatable hemisphere on bottom side (until available in stock)



Art. 995243 ROLA BOLA

Tavola per l'allenamento dell'equilibrio con superficie antiscivolo - i fermi di sicurezza impediscono al cilindro di scivolare all'esterno
Wooden Equilibrium Board with anti-skid on top
The cylinder never slips out of the board thanks to the security wood pieces on bottom side



Art. 14181

Fettuccia con lunghezza 18 metri per l'allenamento dell'equilibrio. Si fissa facilmente tra due alberi ed è perfetta per giocare, allenarsi o fare riabilitazione. Kit completo con sacca e paraalberi
18 meter long tape for balance training. It is easily fixed between two trees and is perfect for playing, training or rehab. Complete kit with bag and tree protections

● pg.8



Art. TBEFS

Blocco per stretching tendineo e muscolare (flessori caviglia e coscia, dorso etc.) con appoggio soffice e sagomato a 2 inclinazioni - ideale per il defaticamento e per il recupero
Stretching block for ankle, leg, back muscles and tendons - with soft double inclination very good for after-training exercises

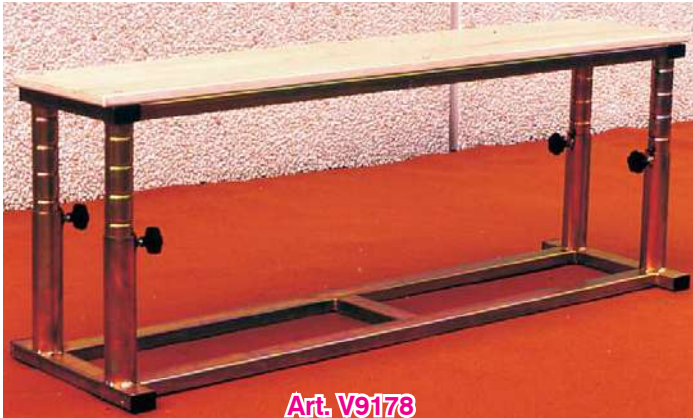

Art. V9178

Plinto per pliometria regolabile in altezza da cm. 30 a cm. 45 in tubolare di acciaio zincato piano di appoggio in legno multistrato dim. cm.150x30
 Plyometric bench adjustable heights (from 30 to 45 cm.) in galvanized steel wooden board dim. 150x30 cm.



**Art. 1PP40/2PP40/3PP40
1PP50/2PP50/3PP50**

Panca per pliometria in acciaio verniciato, lunghezze disponibili: cm. 100 / cm. 200 / cm. 300 larghezza cm. 35 altezze disponibili: cm. 40 / cm. 50 piano di appoggio in legno rivestito in gomma antiscivolo

Plyometric bench in painted steel, available length 100 / 200 / 300 cm. width 35 cm. available height 40 / 50 cm. board made of wood with anti-skid rubber cover



Art. S3PP Set 3 piattaforme pliometriche con 3 diverse altezze: cm. 30, cm. 45 e cm. 60 rivestimento antiscivolo sulla parte superiore e cuscinetti in gomma sotto ciascuna piattaforma per una maggiore sicurezza - impilabili per un pratico stoccaggio

Set of 3 plyometric platforms with 3 different heights: 30 cm., 45 cm. and 60 cm. Anti-skid coating on top and rubber pads under each platform for added safety. Stackable for practical storage



Art. AHF-140

Parallelepipedo per pliometria in legno cm. 76x61x51 utilizzabile a 3 diverse altezze
 Wooden plyometric box 76x61x51 cm. 3 different heights



Art. AHF-255

Parallelepipedo per pliometria in legno cm. 76x61x51 utilizzabile a 3 diverse altezze con finitura antiscivolo
 Wooden plyometric box 76x61x51 cm. 3 different heights anti-skid treatment



Art. AHF-164

Parallelepipedo per pliometria in legno cm. 76x61x51 utilizzabile a 3 diverse altezze con imbottitura in EVA sp. cm. 2
 Wooden plyometric box 76x61x51 cm. 3 different heights EVA padding 2 cm. thickness

● pg.10

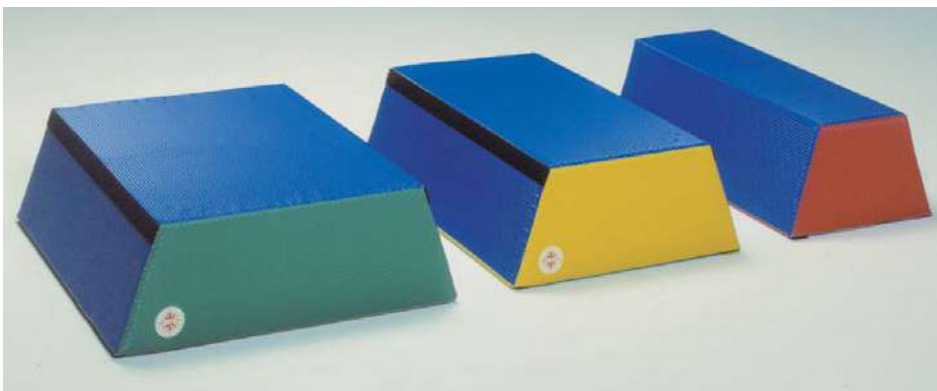

Art. PAV2 Set 3 plinti soft a basi rettangolari in gommapiuma rivestita con PVC ignifugo Cl. 1, sovrapponibili - 3 altezze ottenibili: cm. 30, cm. 60, cm. 90
 Set of 3 rectangular base soft steps - by placing them one upon the other you can get 3 different heights: 30, 60, 90 cm.



Art. VCU60 / VCU70 / VCU80
Cubo per pliometria in legno verniciato al naturale con gomma antiscivolo sui piani di appoggio lato cm. 60/70/80
 Wooden plyometric cube with anti-skid rubber 60/70/80 cm. side

TRAMPOLINI - Trampolines



Art. 166
Trampolino elastico Ø cm. 97
Trampoline Ø 97 cm.



Art. TF-03
Trampolino elastico Ø cm. 122
pieghevole - 40 molle
Trampoline Ø 122 cm.
foldable - 40 springs

pg.7

Art. V1709
Trampolino elastico
ad altezza fissa
dim. cm.125x125
Trampoline 125x125 cm.
reinforced



Art. S01154
Trampolino elastico
ad inclinazione
regolabile
completo di protezioni
dim. cm. 125x125
Trampoline
size 125x125 cm.
adjustable inclination
with soft perimetric
protection

Art. TRO-9
Trampolino da esterno Ø cm. 305
con rete di protezione perimetrale
Outdoor trampoline Ø 305 cm.
with perimetric protection net



SCALE - CERCHI - CORDE - Speed Ladders - Hoops - Jumping Ropes

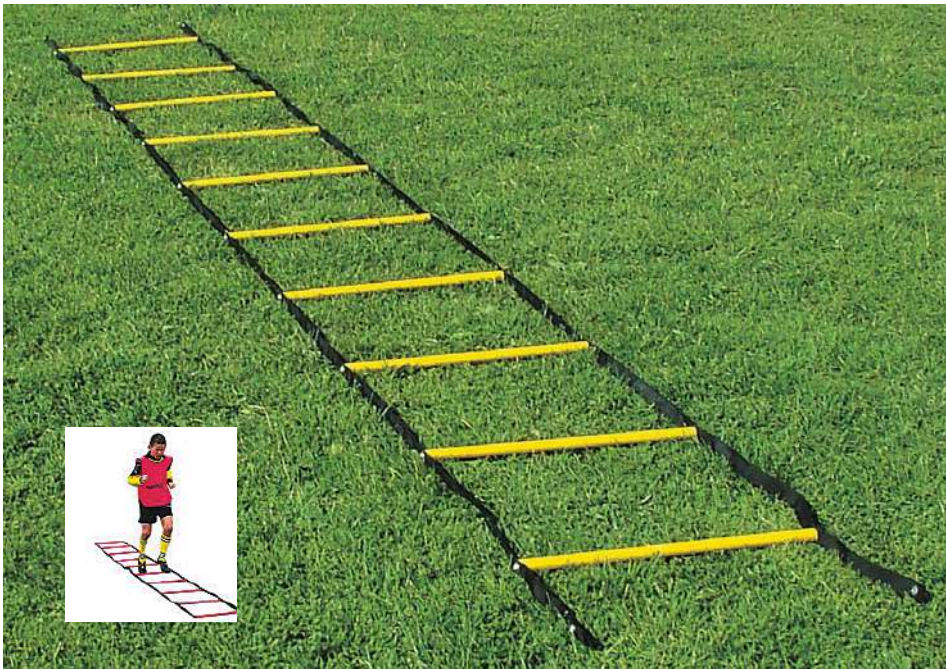

Art. SL4

Scala lunghezza m. 4 con 10 pioli rotondi per esercizi di coordinazione motoria, compresa sacca per il trasporto

Speed ladder length 4 meters with 10 tubular rungs for quick step and coordination exercises, bag included

pg.9

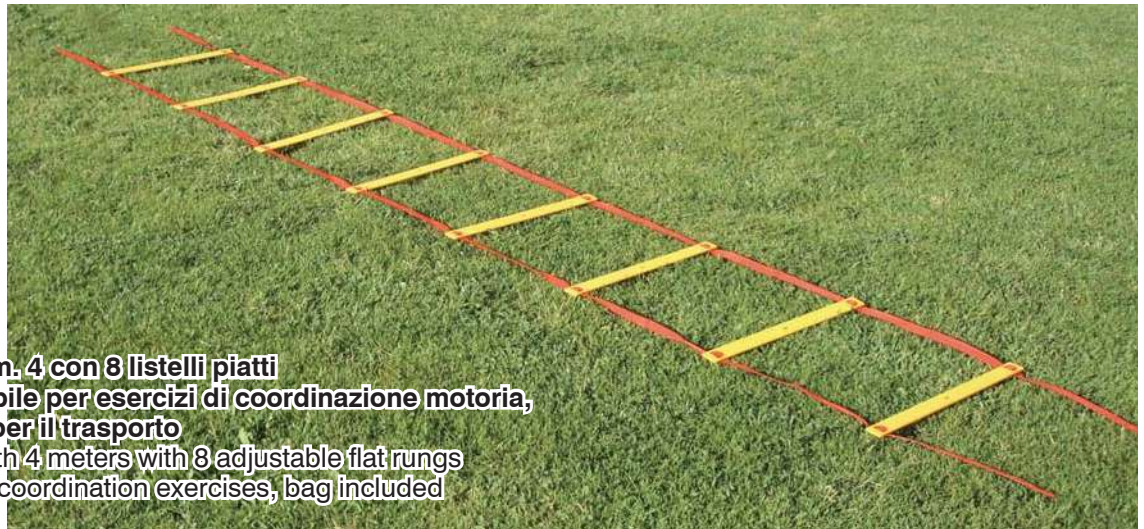

Art. SL4LP

Scala lunghezza m. 4 con 8 listelli piatti a distanza regolabile per esercizi di coordinazione motoria, compresa sacca per il trasporto

Speed ladder length 4 meters with 8 adjustable flat rungs for quick step and coordination exercises, bag included



Art. SL6

Scala lunghezza m. 6 con 12 listelli piatti a distanza regolabile, compresa sacca per il trasporto

Speed ladder length 6 meters with 12 adjustable flat rungs, bag included

Art. S4DB
Scala doppia lunghezza m. 4 con 20 listelli piatti a distanza regolabile per esercizi di coordinazione motoria, compresa sacca per il trasporto
 Double speed ladder length 4 meters with 20 adjustable flat rungs for quick step and coordination exercises, bag included



Art. SK.ELD
ELEVATION LADDER
Scaletta cm. 213 trasformabile in serie di 6 ostacoli h. cm. 10
 Switch between a flat ladder and a series of 6 hurdles h. 10 cm.

Art. B704086
Scala in plastica flessibile lunghezza m.3,80 con 10 pioli spessore cm.2,5 dimensione quadri cm.40x40 - pieghevole con rimessaggio
 Flexible speed ladder length 3,80 meters in plastic with pipes 2,5 cm. thick - foldable with holder



pg.9



Art. 701411
Minibirillo concavo altezza cm. 9 per sollevamento scala Art. B704086 (ad esaurimento)
 Cone 9 cm. height carved on top for Art. B704086 underneath support (until available)

Art. K4111
Kit scala Art. B704086 + 20 Minibirilli Art. 701411 (ad esaurimento)
 Kit Art. B704086 + 20 x Art. 701411 (until available)



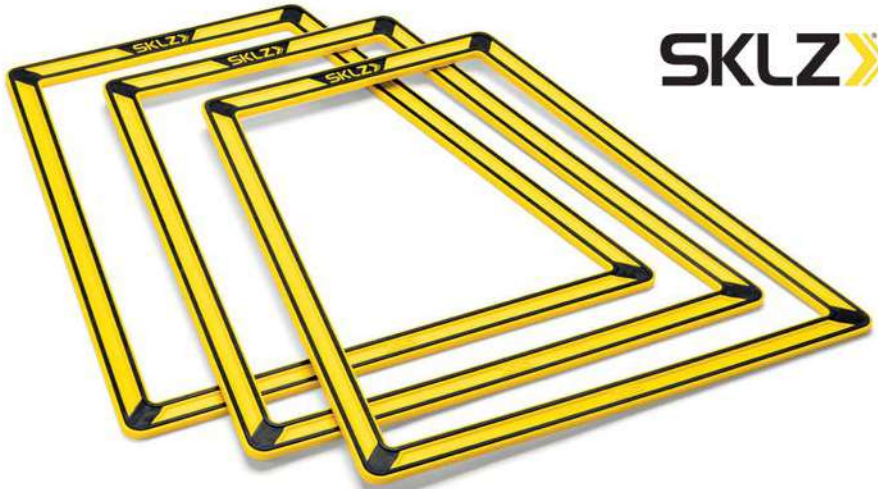

SKLZ

Esempi di combinazioni possibili
A few examples

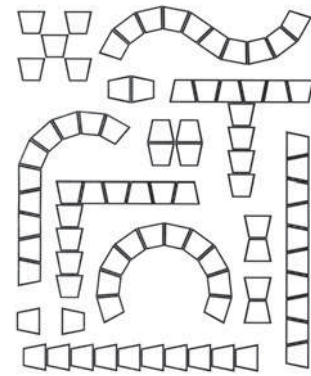

Art. SK.ATP
AGILITY TRAINER PRO - set 10 TRAPEZI componibili per allenamento agilità e coordinazione multidirezionale, e per il miglioramento della velocità e dei tempi di reazione

Agility Trainer Pro - customizable footwork and agility trainer designed for curvilinear and alternative training patterns, cuts your reaction time while adding speed in all directions. Set of 10 trapezoids with a carry handle



Con questo nuovo strumento di allenamento creativo si possono incrementare le doti di rapidità, agilità e potenza nei cambi di direzione e nelle traiettorie curvilinee che gli atleti sono chiamati ad effettuare durante la gara. Questi speciali trapezi sono molto stabili su ogni tipo di terreno, permettendo così un esercizio senza interruzioni



pg.9



Sports don't happen in a straight line, now neither does your training. The Agility Trainer Pro lets you recreate the curvilinear and broken patterns that take place in sports, helping you set up your cuts, turns and changes of direction. It lets you add the multi-directional quickness and precise footwork that can quickly change the game. The Agility Trainer Pro won't slip, slide or otherwise interrupt your training sessions

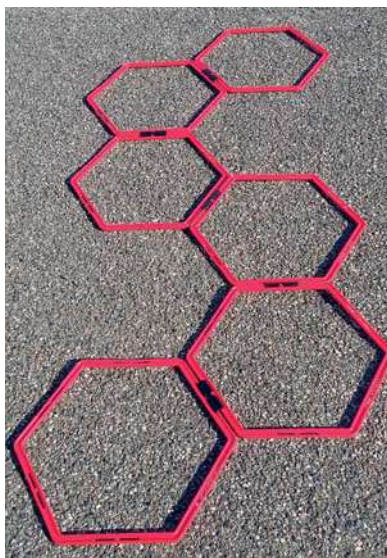

Art. HEXS6 Set 6 esagoni in plastica componibili dim. cm.45x53 (altezza, larghezza) lato cm.28, completi di clip e borsa colori: giallo, verde, rosso, azzurro

Set of 6 modular plastic hexagons 45x53 cm. (height, width) complete with clips and bag - colors: yellow, green, red, royal

pg.9

**Video dimostrativo disponibile
su www.barretsport.com**
Video available on
www.barretsport.com



Art. SQ15.NS

**Set 6 elastici con
velcro di ricambio**
Set of 6 spare elastics
with velcro

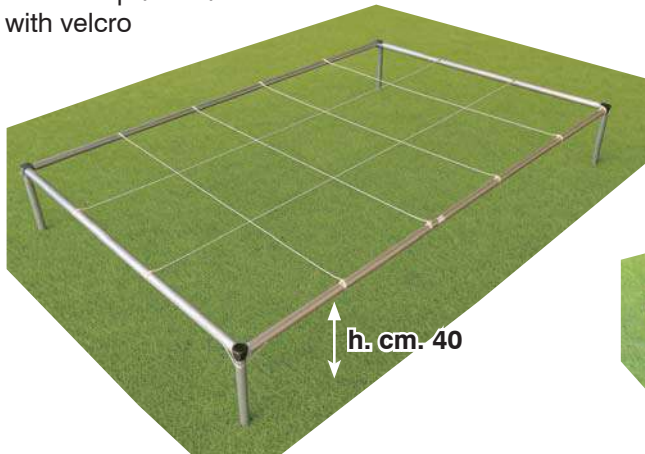

pg.10

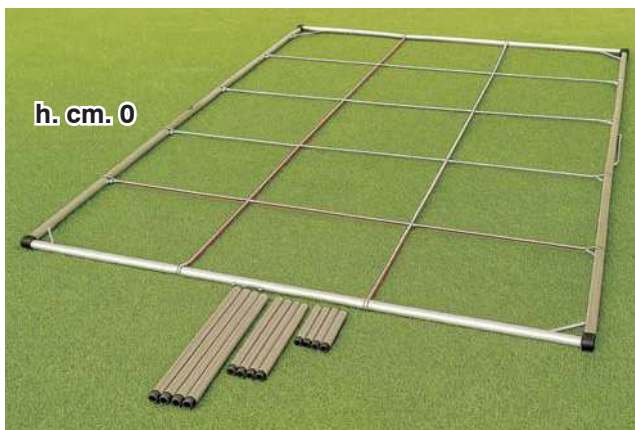
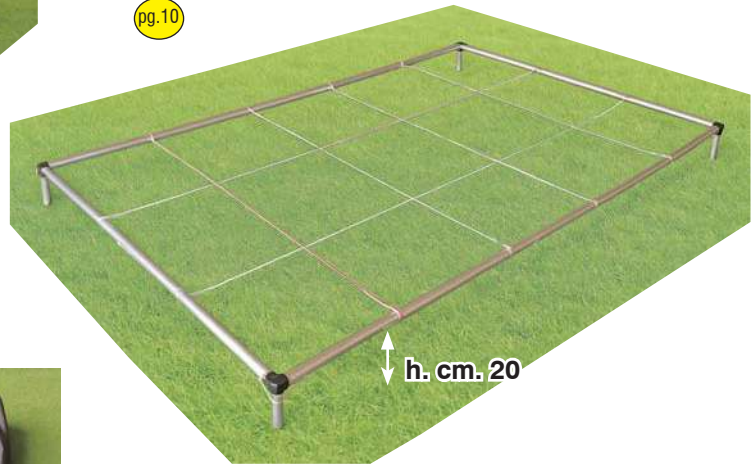

**Morbidi elastici
flessibili fino
a terra**
Soft elastic
bands
flexible down
to the ground

Art. SQ15
15 SQUARES
Telaio di cm. 300x200
in alluminio Ø mm.32
**6 elastici con velcro consentono
di formare 15 quadri per esercizi di
coordinazione, reattività, riscaldamento
e potenziamento muscolare
con piedi di sostegno intercambiabili
utilizzabile alle seguenti altezze
dal terreno: cm.0 / cm.20 / cm.40 / cm.60
kit completo di borsa per il trasporto
e di 6 elastici di ricambio (che consentono
eventualmente di formare un numero maggiore di quadri)**
Aluminium frame 300x200 cm. pipe Ø 32 mm.
equipped with 6 elastic bands with velcro forming 15 squares for
warm up, coordination, reactivity and jumping exercises
with interchangeable sets of support feet adjustable at the following
heights from ground: 0 cm. / 20 cm. / 40 cm./ 60 cm.
with carrying bag and 6 additional spare elastics
(which eventually allow you to form
a greater number of squares)



Colori giallo, rosso, blu e verde

Art. CNP30 / CNP40 / CNP50 / P00181 / P00191 / P00201
Cerchio in nylon piatto Ø cm. 30 / 40 / 50 / 60 / 70 / 80
 Flat Nylon Hoop Ø 30 / 40 / 50 / 60 / 70 / 80 cm.



Art. P00182 / P00192 / P00202 / P00212
Cerchio in PVC tubolare Ø cm. 60 / 70 / 80 / 90
 Tubular PVC hoop Ø 60 / 70 / 80 / 90 cm.



Art. S00402/S00405/S00406
Bastone in legno
 cm. 80-100-120
 80-100-120 cm. Wooden Stick

Art. E21
Bastone in PVC cm.120
 120 cm. PVC Stick

pg.9

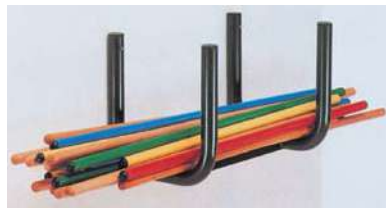

Art. S00414
Mensola porta bastoni a parete
 in acciaio verniciato
 Stick wall Holder in painted steel



Art. OCC11
Connettore per cerchi piatti
 Flat Hoop Connector



Art. S00472
Mensola porta cerchi a parete in
 acciaio verniciato
 Hoop wall Holder in painted steel



Art. 043
Corda per salto in canapa con manici
 in legno ed ingrossamento centrale
 Hemp Skipping Rope with hardwood
 handles, thicker in the middle section



Art. CS1
Corda per salto in canapa con ingrossamento
 centrale senza manici
 Hemp Skipping Rope thicker in the middle without handles

pg.8

Art. 043P
Corda per salto in nylon
 con manici in legno
 Nylon Skipping Rope with
 hardwood handles



Art. AHF-017
Corda per salto in PVC
 con manici soft touch
 e cuscinetti a sfera
 PVC Skipping Rope with soft
 handles and ball bearings

Art. AHF-102
Corda per salto veloce in acciaio
 con manici in plastica e cuscinetti
 a sfera (lunghezza regolabile)
 Steel Skipping Rope with plastic
 handles and ball bearings
 (adjustable length)



Art. 043L Corda per
 salto in pelle
 Leather Skipping Rope
 with hardwood handles



Art. STAR
Starkick completo di cintura e corda elastica per allenamento ai palleggi ed al tocco di palla (pallone escluso)
 Starkick with belt and elastic rope for ball kick and control training (ball not included)



pg.10

Art. PTI.15070
Soccer Ball Trainer completo di pallone, corda elastica di m. 12,5 e ancoraggio
 Soccer Ball Trainer with ball size 5 in TPU, rubber base, 12,5 m. elastic rope and 1 peg



Art. OTK
Training Kicker con corda non elastica per allenamento ai palleggi ed al tocco di palla (pallone escluso)
 Training Kicker with non elastic rope for ball kick and control training (ball not included)



pg.10

Art. TIM.SP
Supporto per Tackle Improver
 Holder for Tackle improver

Art. TIM
Tackle Improver per allenamento al contrasto
 For tackle training

Uno strumento innovativo per migliorare la tecnica di esecuzione e la potenza del contrasto. Il Tacke Improver indirizza il piede d'appoggio verso la posizione più idonea per esprimere la maggiore potenza d'impatto. Potenzia inoltre tutte le catene muscolari che intervengono nel contrasto, ma senza causare traumi, grazie ad una speciale molla collegata al pistone che sorregge il pallone.

Very useful training device for strengthening all muscles involved in tackling. Absolutely safe, thanks to a spring and piston system that avoids injuries.



Art. CVCO
Cavigliera Coordinativa con contrappeso, migliora l'equilibrio e l'indipendenza psicomotoria delle gambe, ed in particolare ammorbidisce la gamba dominante migliorando la sensibilità dell'altro piede
 Rotating ankle, with weight, to improve equilibrium and leg independence: in particular it softens the dominant leg improving sensibility of the non dominant foot



Video dimostrativo disponibile su www.barretsport.com
 Video available on www.barretsport.com

ALLENAMENTO SOTTO CARICO E FUNZIONALE - Training with weights



Art. SLD



Art. ASN

Cintura in pelle sintetica con velcro completa di corda, catena e moschettoni di ricambio per slitta Art. SLD
Synthetic leather belt, rope and chains spare for Art. SLD



Art. CBV

Cintura in pelle sintetica con velcro di ricambio per Art. SLD
Synthetic leather belt w/velcro spare for Art. SLD

Art. SLD Slitta per il miglioramento della capacità di accelerazione tramite il traino a carico variabile completa di cintura in pelle sintetica con velcro, corda e moschettoni (dischi in ghisa non inclusi)
Sledge (weights not included) improving acceleration with synthetic leather belt, rope and chains

pg.9



SKLZ



In dotazione 3 sacchi di capacità Kg. 4,5 da riempire con sabbia
Includes 3 x 4,5 Kg. sacs to be filled with sand



Art. SK.SPSC
SPEED SAC - sacca di traino con pesi munita di cintura e moschettoni utilizzabile anche indoor o su superfici sintetiche
Improves overall speed and explosiveness, boosts acceleration and stride length. Adjustable weight options for variable resistance portable and versatile to be used anywhere



Art. 045 / AHF-112 / AHF-113
Giubbino caricabile con pesi fino a Kg.10-20-30 (pesi inclusi)
Jacket Weighted up to 10-20-30 Kg. (weights included)



Art. PCH
Paracadute per potenziamento della corsa
Parachute to improve the power of your run

pg.9

Art. TBB2 / ... / TBB6
Body Bar
Kg. 2-3-4-5-6 per
allenamento funzionale
con pesi liberi
Body Bar
2-3-4-5-6 Kg.
for functional training
with free weights



pg.12



Art. 991310M/991311M/991312M
Shoulder Bag
con 3 impugnature
pesi disponibili Kg. 10-15-20
Shoulder Bag with
3 handles
weights available 10-15-20 Kg.

pg.9

Shoulder Bag kg. 5 e kg. 12
disponibili fino ad esaurimento scorte
Shoulder Bag 5 kg. and 12 kg.
until available



**Art. APBG-5/APBG-10/APBG-15/
APBG-20/APBG-25**
Borsa zavorrata
con 6 impugnature
pesi disponibili Kg.5-10-15-20-25
Heavy Bag with 6 handles
weights available 5-10-15-20-25 Kg.

pg.9

Art. WBG
Borsa gonfiabile zavorrata con acqua a peso variabile
(capacità da 5 a 25 litri) lunghezza cm. 90 con 4 maniglie
consente nuovi esercizi di forza coordinata
grazie alla massa oscillante interna - pompa inclusa
Inflatable bag with water inside (from 5 up to 25 liters), length 90 cm.
with 4 handles, allows new exercises for muscle strength thanks to
the dynamic weight inside - pump included



Art. BR-3812 / BR-5015
Fune da allenamento
Battle Rope
ø mm 38 lunghezza mt. 12
oppure
ø mm 50 lunghezza mt. 15
Battle Rope
12 meters - 38 mm. thick or
15 meters - 50 mm. thick

pg.9



In poliestere intrecciato con impugnature rivestite in gomma termoretraibile
ideale per il potenziamento dei muscoli di spalle e avambracci,
ottimo allenamento cardiorespiratorio
Polyester encased rope with shrink-wrap handles, perfect for strengthening shoulders
and forearm muscles, excellent cardio-respiratory workout

FUNCTIONAL TRAINING



pg.9

Art. FT.IST

Functional Training
Attrezzo polifunzionale
per il potenziamento della catena estensoria
e flessoria degli arti superiori e inferiori
 Functional Training multi-purpose
 belt for the enhancement
 of the extension and flexion muscular
 chains of the upper and lower limbs



Art. FST-DBL

Functional Training Double Pro
Attrezzo professionale per allenamento
in sospensione con maniglie svincolate
utilizzabili separatamente
 Functional Training with free handles to be used also
 separately - steel snap hooks and rings



Art. MTLTX

Lacci di Trazione
Traction Laces

Art. PLTRZ

Prolunga
per Lacci
di Trazione
Extension for
Traction Laces



Attrezzo polifunzionale per il potenziamento della catena
estensoria e flessoria degli arti superiori e inferiori
 Multi-purpose belt for the enhancement of the extension and
 flexion muscular chains of the upper and lower limbs

New!



Art. TRXM

TRX® MOVE - suspension trainer della
gamma TRX® ottimo per gli allenamenti di
tutti i livelli. Costruito con materiale resistente
e con moschettone testato per più di 320 Kg,
aiuta a bruciare i grassi e a migliorare
la forza muscolare

Suspension trainer from the TRX® range
 excellent for training of all levels. Built with
 resistant material and with a carabiner tested for
 more than 320 kg, it helps burn fat and improve
 muscle strength



Art. DTL15

Lacci di Trazione
dinamici
con carrucola
Dynamic functional
training with pulley



BANDE ELASTICHE - BOA - Elastic Bands



pg.11



- Art. MBLT** MINI BAND LIGHT in poliestere ø cm.20,70 h.mm.50
- Art. MBME** MINI BAND MEDIUM in poliestere ø cm.18,80 h.mm.50
- Art. MBST** MINI BAND STRONG in poliestere ø cm.19,10 h.mm.50
- Art. MBEX** MINI BAND EXTRA STRONG in poliestere ø cm.19,10 h.mm.54

Polyester Mini Bands



Art. AHF-141
Coppia maniglie per fitness band
Pair of handles for fitness band

Art. IFBG
Fitness band cm. 175x15
colore giallo
Yellow fitness band

Art. IFBR
Fitness band cm. 175x15
colore rosso
Red fitness band

Art. IFBB
Fitness band cm. 175x15
colore blu
Blue fitness band

Art. IFBN
Fitness band cm. 175x15
colore nero
Black fitness band



Ogni set in un colore
Each set in one color

Art. 991707 / 991708 / 991709

SET 10 ELASTICI AD ANELLO colore giallo (morbido) rosso (medio) - verde (resistente) Ø cm. 27,50
Set of 10 Elastic Rings yellow (soft) red (medium) - green (hard) Ø 27,5 cm.

pg.12



Art. AHF-251/AHF-128/AHF-129
AHF-130/AHF-131/AHF-132

Elastico ad anello POWER BAND
circonferenza cm. 208 spessore mm. 4,5
larghezza arancio mm. 6,4 - rosso mm. 13
nero mm. 22 - viola mm. 29 - verde mm. 45 - blu mm. 64
Power Band elastic circumference cm.208 - 4,5 mm. thick
orange 6,4 mm. width - red 13 mm. width
black 22 mm. width - violet 29 mm. width
green 45 mm. width - blue 64 mm. width



Art. RLEV
Rotolo lattice verde per esercizi muscolari,
larghezza cm. 15, lunghezza mt. 25
spessore 0,3 mm.
Elastic green Band for muscle exercises,
15 cm. wide, 25 meter long, thick 0,3 mm.

pg.11



Art. RLEF
Rotolo lattice fucsia per esercizi muscolari,
larghezza cm. 15, lunghezza mt. 25
spessore 0,4 mm.
Elastic fuchsia Band for muscle exercises,
15 cm. wide, 25 meter long, thick 0,4 mm.



Art. RLEB
Rotolo lattice blu per esercizi muscolari,
larghezza cm. 15, lunghezza mt. 25
spessore 0,5 mm.
Elastic blue Band for muscle exercises,
15 cm. wide, 25 meter long, thick 0,5 mm.





pg.12

Art. KER-IS

Set 5 elastici con 5 diverse resistenze dotati di ganci metallici da entrambi i lati. Completo di 1 coppia di maniglie, 1 coppia di cavigliere, 1 accessorio per bloccare l'elastico contro una porta e utilizzare un arto per volta, 1 sacca

Set of 5 elastic bands with 5 different resistances equipped with metal hooks on both sides. Complete with 1 pair of handles, 1 pair of ankle bands, 1 accessory to lock the elastic against a door and use one limb at a time, 1 bag

Here are some examples of the door anchor in action:

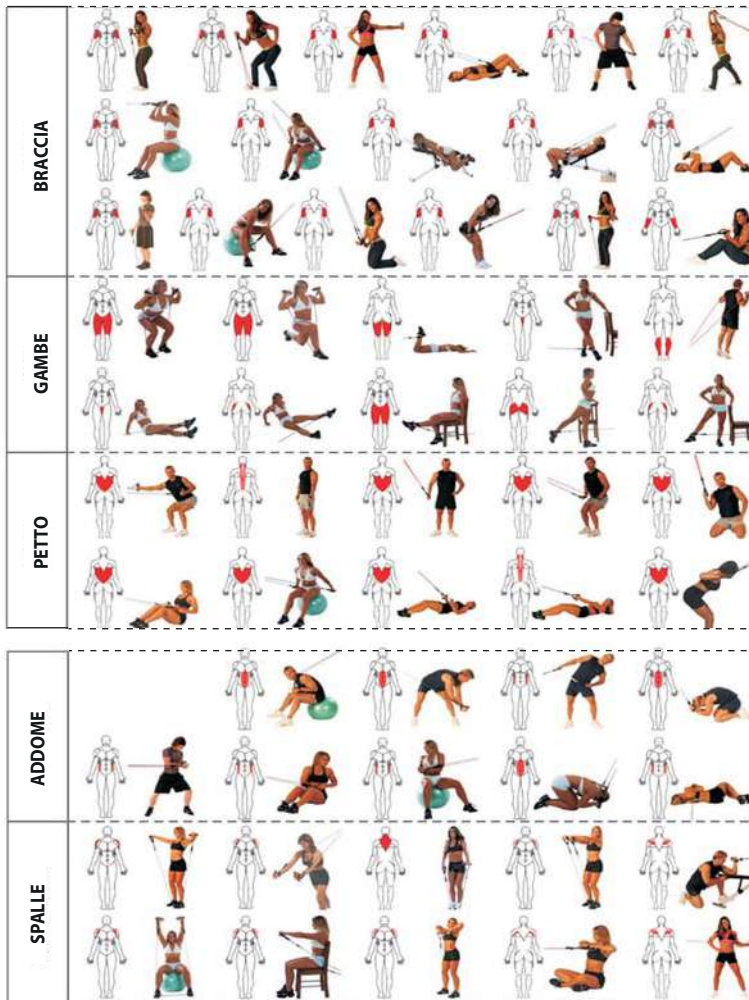

GANCIO SU 1 ELASTICO GANCIO SU 2 ELASTICI GANCIO SU 3 ELASTICI GANCIO SU 4 ELASTICI GANCIO SU 5 ELASTICI



COLORE ELASTICO	LIVELLO DI RESISTENZA	LIVELLO DI RESISTENZA	DIMENSIONI
GIALLO	EXTRA LEGGERO	2,7 kg - 3,6 Kg	5X8X1100MM
VERDE	LEGGERO	4 kg - 5 Kg	6X9X1100MM
ROSSO	MEDIO	5,5 kg - 6,75 Kg	5X9X1100MM
BLU	FORTE	6,75 kg - 9 Kg	5X10X1100MM
NERO	EXTRA FORTE	9,45 kg - 11,25 Kg	6X11X1100MM

1. Your resistance bands come in 5 different resistance levels, noted by a different band color. Please refer to the table for more information on the levels of resistance
2. You can use any or all of the bands at one time during your workouts
3. Attach one end of the band(s) to the foam handles or ankle straps and same on the other end
4. The door anchor will attach anywhere on a standard door, including the bottom of the door. To use the door anchor, ensure the bigger end is attached to the apposite side of door and feed the thin end through. Once the thin end is through you can feed the exercise band through it. Ensure the door is fully closed before performing any exercise

Resistance Band Color	Resistance level	Resistance level	Dimensions
Yellow	X- Light	6lbs - 8lbs	5X8X1100MM
Green	Light	9lbs - 11lbs	6X9X1100MM
Red	Medium	12lbs - 15lbs	5X9X1100MM
Blue	Heavy	15lbs - 20lbs	5X10X1100MM
Black	X-Heavy	21lbs - 25lbs	6X11X1100MM



pg.11

Art. PTI.SPS

Slide Pads - paio di slide pads utilizzati per esercizi di scivolamento di mani e piedi volti al miglioramento della flessibilità e della forza muscolare (ad esaurimento)

Conditioning tool to improve flexibility, shaping and core strength, simulates many slide board exercises Set of 2 pcs (until available)



Art. 991710/ ... /991738
Elastico tubing con maniglie
colore rosso, giallo, viola, nero
 Elastic with handles
 red, yellow, violet, black color



Art. 991714/ ... /991742
Elastico tubing mt.10 senza maniglie
colore rosso, giallo, viola, nero
 10 meter elastic without handles
 red, yellow, violet, black color



pg.11 pg.12



Art. AHF-167
Elastico tubolare con guaina
e maniglie light cm.150x15
spessore mm. 0,35
 Light elastic tube with sheath
 and handles 150x15 cm.
 thickness 0,35 mm.

Art. AHF-168
Elastico tubolare con guaina
e maniglie medium cm.150x15
spessore mm. 0,50
 Medium elastic tube with sheath
 and handles 150x15 cm.
 thickness 0,50 mm.

Art. AHF-169
Elastico tubolare con guaina
e maniglie strong cm.150x15
spessore mm. 0,65
 Strong elastic tube with sheath
 and handles 150x15 cm.
 thickness 0,65 mm.



Art. AHF-068
Set 3 elastici tubing con maniglie
tre differenti livelli di resistenza
impugnature ergonomiche soft touch
per esercizi arti superiori e inferiori
completo di borsa in microrete
 Set of 3 elastics with soft touch handles
 3-level resistance, bag included
 tones and strengthens
 arms, legs, gluteus, abdominals,
 shoulders and chest muscles



pg.11

Art. ARS.3
Banda Elastica rinforza spalle - può essere usata in ogni luogo che abbia un appiglio per la chiusura
a velcro (anche in casa o in albergo) grazie alla presenza di uno spessore che, a porta chiusa,
non fa scivolare l'attrezzo e non danneggia la porta
 Elastic Band for shoulder injury training exercises

Art. 016824
ELASTICO BOA in gomma para mm. 7x18
rivestito con guaina di sicurezza lunghezza mt. 3
con un moschettone a ciascuna estremità,
resistenza Kg. 50
 Rubber BOA 7x18 mm. with safety sheath
 3 meter length, resistance 50 Kg.

pg.11



Art. 016827
Paio polsini per elastico BOA
 Pair of wristbands for BOA exercises



Art. 016824
ELASTICO BOA

Art. 016826
CINTURA Senior

Si suggerisce l'utilizzo dell'elastico BOA con una cintura o con un altro tra gli accessori disponibili

Utilization of rubber Boa is suggested with a belt or with another available accessory



Art. 016828
Paio cavigliere per elastico BOA
 Pair of anklebands for BOA exercises

Art. 016825
CINTURA Junior da agganciare a elastico BOA
diametro max cm.105
 Junior Belt for BOA traction
 max diameter 105 cm.

Art. 016826
CINTURA Senior da agganciare a elastico BOA
diametro max cm.140
 Senior Belt for BOA traction
 max diameter 140 cm.

pg.11



Art. 016829
Pettorina per elastico BOA
 Shoulder belt for BOA exercises



Art. C3005
Staffa per ancoraggio elastico BOA a parete
 BOA wall anchor bracket

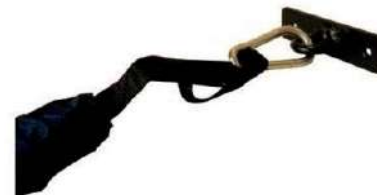

Anello scorrevole
 "free-floating" ring



SKLZ

Art. SK.R360
RECOIL 360 - elastico con cintura ad anello scorrevole
utilizzabile in autonomia o con l'aiuto del preparatore
resistenza Kg. 22
 Maximizes power, speed and vertical jump
 Engineered with a "free-floating" ring for 360 degrees of movement
 Designed for solo use or for training with a partner
 resistance 22 Kg.

pg.11

DYNAMIC RESISTANCE / ASSISTANCE TRAINER



Art. SK.ACTR
ACCELERATION TRAINER
per l'allenamento della velocità in ogni direzione,
dell'accelerazione e della velocità massima
Da utilizzare con l'aiuto del preparatore
Trains speed in every direction
Builds speed and power from the start,
during acceleration and at the top-end
Designed for training with a partner



pg.11

DYNAMIC OVERLOAD AND RELEASE SYSTEM



Anello scorrevole
"free-floating" ring



Art. SK.LRP
LATERAL RESISTOR PRO
Attrezzo per migliorare la velocità del primo passo
e la rapidità laterale con elastici tubolari
intercambiabili a diversa resistenza
Develops first-step quickness and lateral speed
Patented Slide-Lock system for quick, safe
switching of resistance cables



STRENGTH AND SPEED TRAINER



pg.11



VERTICAL JUMP TRAINER



Art. SK.HPZ
HOPZ 2.0

Attrezzo per migliorare la forza e la potenza dei muscoli
impegnati nell'elevazione, con elastici tubolari
intercambiabili a diversa resistenza
Builds explosive leg power and strengthens jumping muscles
You can move resistance cables on belt to target specific
muscles and change resistance cable quickly





Con velcro cucito su
entrambe le estremità
With velcro seamed at
both sides

Art. AE

Banda elastica Antonelast per esercizi di stretching e potenziamento muscolare
Elastic band for body muscle exercises

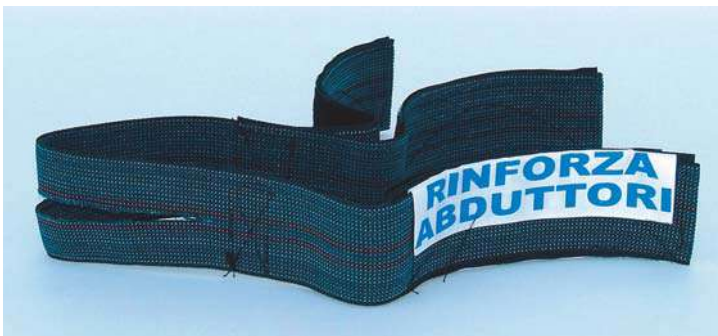

Con velcro cucito su
entrambe le estremità
With velcro seamed at
both sides

Art. RA
Rinforza Abduttori
Elastic band for
abductor muscles



Con velcro cucito su entrambe le estremità
With velcro seamed at both sides

Art. OSI.5
Over Speed Improver
lunghezza 5 metri
Over Speed Improved
length 5 meters

Art. OSI
Over Speed Improver lunghezza 3 metri - Tramite questa cintura elastica l'atleta più veloce
trascina il più lento, incrementando contemporaneamente la velocità di entrambi
By this 3 meter elastic belt the quicker player pulls the slower player, increasing both athletes' speed

pg.11



Art. PSR
Power Speed
Resistor
per potenziamento
della corsa
esercizio in coppia
(nylon non elastico)
To improve explosive
force - two people
involved (non elastic
band)

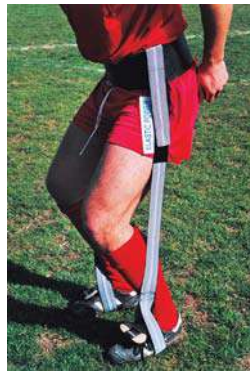

Art. EPW
Elastic Power
2 fasce con cintura
in pelle
incrementa
la forza esplosiva
potenziando la
muscolatura delle
gambe e del dorso
2 Bands with leather belt
for explosive strength
improvement, for leg and
back muscle training

pg.11



Cintura elastica
Elastic belt

Art. SRE
Speed Reaction
Allenamento dei riflessi e
della reattività
(l'elastico non si sgancia se
il difensore perde contatto
dall'attaccante)
Reflex and reactivity training
device (the belt does not
separate if the defender
looses contact)



pg.11



Cintura non elastica
Non elastic belt

Art. EB
Evasion Belt - Allenamento
dei riflessi e della reattività
ideale per
marcature a uomo
(la cintura si sgancia se il
difensore perde contatto
dall'attaccante)
Reflex and reactivity training
device, for man to man
coverage (the belt separates if
the defender looses contact)



Art. RIM
Reaction Improver
per l'allenamento della reazione allo stimolo
visivo in percorsi ad ostacoli, ideale per
marcature a uomo
(l'elastico si stacca se si perde contatto)
Elastic Belt for visual reflex training in drill
sections, for man to man coverage (the elastic
separates if following athlete looses contact)

pg.11



Art. KAT Kit allenamento tattico composto da
7 bande elastiche di metri 10 cadauna
Tactical training kit made of 7 elastic bands
10 meter long each

pg.11



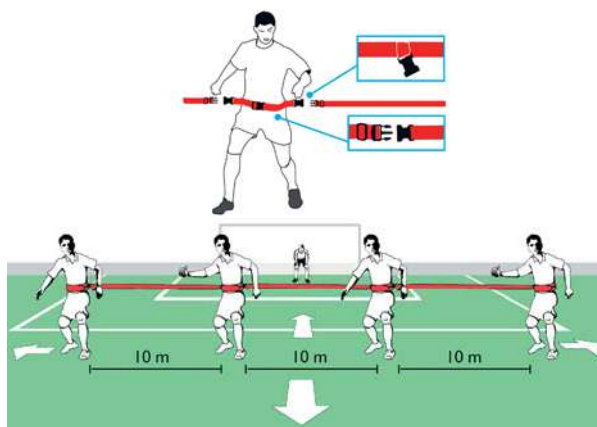

pg.11

Art. 05020798

Set di 4 cinture con dispositivo di fissaggio e 3 fasce non elastiche lunghe m. 10 ciascuna
Con questo prodotto è possibile vincolare quattro difensori allenandone il posizionamento ed i movimenti sul campo (ad esaurimento scorte)

Set of 4 hip belts with fasteners and 3 unelastic bands 10 m. long each
 With this kit you can connect all four players of your defensive block, training their positioning and movements on the field (until available in stock)

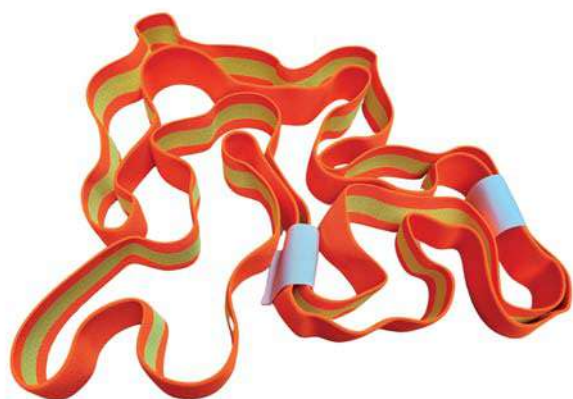

Art. ELAC

Fascia elastica ad anello in tessuto extra strong circonferenza cm. 400 - h. cm.5 pensata per l'allenamento multidirezionale consente lo sviluppo di forza, esplosività, velocità, agilità e salto

Elastic extra strong fabric loop band circumference 400 cm. - h. 5 cm. designed for multidirectional training allows the improvement of strength, explosiveness, speed, agility and jumping

pg.11



Art. KAP

Kit allenamento portiere composto da 10 Antonelast, 1 cintura, 1 Rinforza Abduttori, 4 anelli fissa bande per il miglioramento della forza esplosiva

Goalkeeper training kit
 made of 10 Antonelast, 1 belt, 1 abductor muscle band, 4 connecting rings to improve explosive muscular strength and goalkeeper's jumps and dives



Art. 05021456

JUMP-TRAINER

Strumento per migliorare la potenza nel salto. Un atleta indossa la cintura regolabile con velcro, due compagni trattengono le fasce elastiche salde a terra - lunghezza delle fasce elastiche m. 1,20 ciascuna in posizione di riposo (ad esaurimento)

Training tool to improve jump power. One player puts on the adjustable hip belt with velcro fastener, two training partners hold the elastic bands on the ground using their feet - length of elastic side bands not stretched 1,20 m. (until available)

pg.11

Art. SC010

OFFERTA KIT TECNICO SCUOLA CALCIO

pg.10

Kit così composto: n.15 paletti slalom Art.007
n. 15 basi ad imbuto Art.018 - n. 1 kit delimitatori Art.016 - n. 6 ostacoli over cm.12 Art.80.12
n. 2 ostacoli over cm.20 Art.80.20 - n. 2 ostacoli over cm.30 Art.80.30 - n. 2 ostacoli over cm.40 Art.80.40
n. 12 corde salto Art.043P - n. 1 scala a pioli Art.SL4 - n. 12 maxidelimitatori h.cm.28 Art.019.1
n. 12 cerchi piatti diam.cm.50 Art.CNP50 - n. 1 tavoletta propriocettiva in ABS Art.168PC

SOCCER SCHOOL KIT SPECIAL OFFER

15 x Art.007 + 15 x Art.018 + 1 x Art.016 + 6 x Art.80.12 + 2 x Art.80.20 + 2 x Art.80.30 + 2 x Art.80.40
+ 12 x Art.043P + 1 x Art.SL4 + 12(pieces) x Art.019.1 + 12 x Art.CNP50 + 1 x Art.168PC

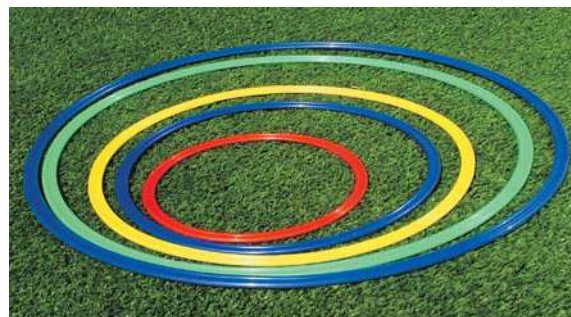

FITNESS BODY-BUILDING

Art. S01108

Art. S01106

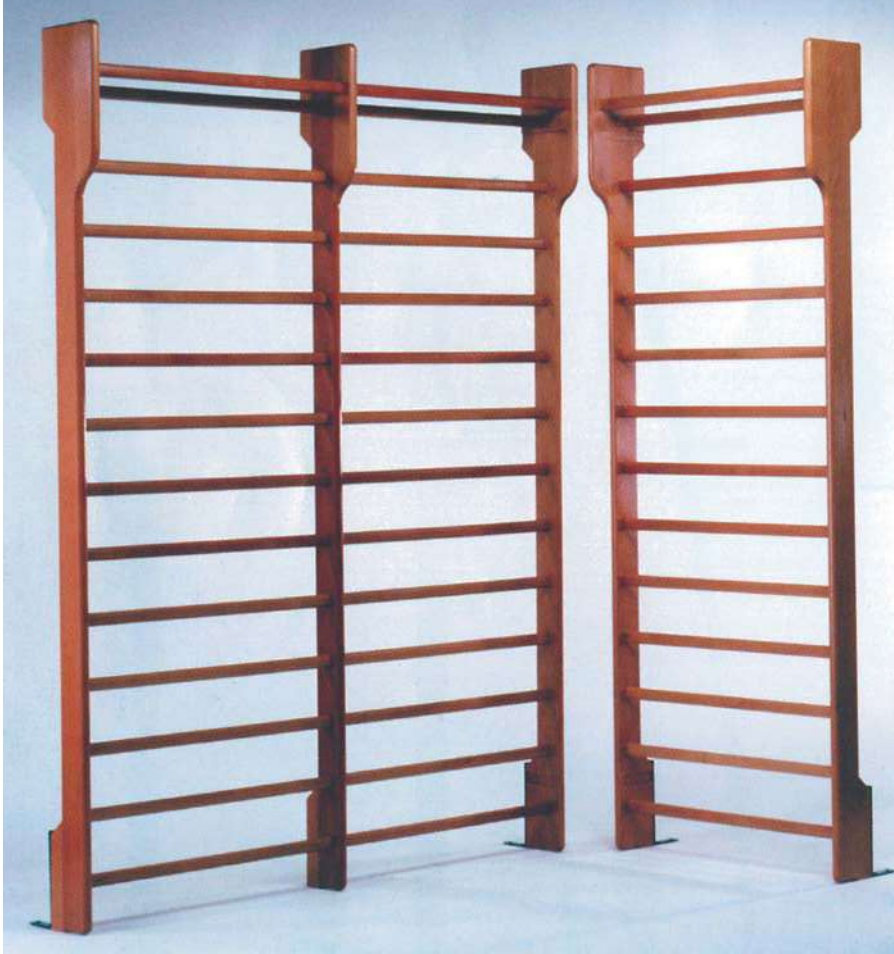

Art. S01106

Spalliera Svedese
a 1 campata
dim. cm. 90x250 pg.14
in faggio evaporato
Swedish Wall Bar 1 span

Art. S01108

Spalliera Svedese
a 2 campate
dim. cm. 180x250
in faggio evaporato
Swedish Wall Bar 2 spans



Art. F302

Porta dischi in ferro
Weight Plates Rack



Art. UNG05 / UNG1 / UNG2 / UNG3 / UNG4 / UNG5 / UNG6

Coppia Manubri in ghisa rivestiti

Kg. 0,5-1-2-3-4-5-6 cadauno

Pair of Dumbbells 0,5-1-2-3-4-5-6 Kg. each one

pg.12

pg.13



Art. F301

Porta manubri in ferro
Dumbbell Rack

Art. MEG6 / MEG7 / MEG8 / MEG9 / MEG10

Manubrio esagonale con rivestimento in gomma Kg. 6-7-8-9-10
(fornito singolarmente)

Hexagonal Dumbbell with rubber coating 6-7-8-9-10 Kg.





Art. AS196
Coppia
fermadischi a vite
Ø mm. 25
Pair of plate
holders with
thread

****Art. US301** Manubrio a
dischi inseribili
cm. 35 Ø mm. 25
Hand bar length 35 cm.

pg.12

****Art. US304 / US305**
Bilanciere cm. 150 / cm. 180
Ø mm. 25
Barbell length 150 / 180 cm.



Art. UN640
Disco in ghisa foro mm. 25
Kg. 0,5 - 1 - 2 - 5 - 10 - 15 - 20
cadauno
Cast Iron Weight Plate
hole 25 mm.

****Fermadischi inclusi**
Plate holders included
Carico massimo Kg. 100
Maximum load 100 Kg.



Art. DGG
Disco in ghisa foro mm. 25
rivestiti in gomma
Kg. 0,5 - 1 - 2 - 5 - 10 - 15 - 20 cadauno
Cast Iron Weight Plate hole 25 mm.
covered with rubber

Art. US287
Coppia fermadischi
a molla
Ø mm. 25
Pair of spring
plate holders



Art. BO220
Bilanciere olimpionico cm. 220
cromato per dischi con foro da mm. 50
carico massimo Kg.320 - fermadischi non inclusi
Chromed olympic barbell 220 cm.
maximum load 320 Kg. for plates with hole 50 mm. only
(plate holders not included)

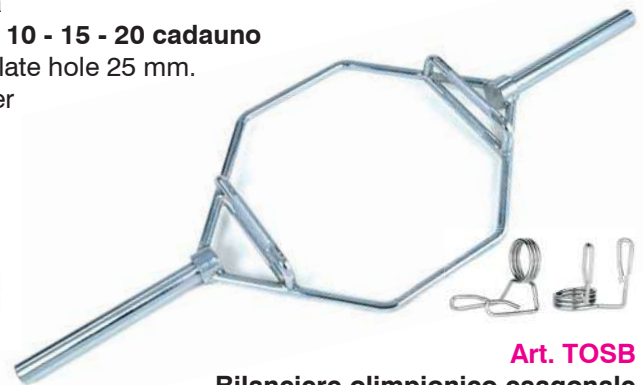

Art. TOSB
Bilanciere olimpionico esagonale
cm. 145 con doppia impugnatura (shrug bar)
per dischi con foro da mm. 50 - carico massimo Kg.300
fermadischi a molla inclusi
Hexagonal olympic barbell 145 cm. with double handle
for plates with hole 50 mm. - maximum load 300 Kg.
spring plate holders included



Art. CFSL
Coppia fermadischi
per Art. BO220 - Ø mm. 50
Pair of plate holders for Art. BO220



Art. AHF-155 Landmine Total Core
Piattaforma con superficie inferiore
antiscivolo, snodo rotante a 360° e
doppio innesto per bilanciere
Ø mm. 25 / mm. 50 - dotato di
maniglia "T-Bar" per estendere
la gamma di esercizi
Platform with anti-skid lower surface,
360° rotating pin and double joint for
Ø 25 / 50 mm. barbell
equipped with "T-Bar" handle to
extend the range of exercises

Art. DBCH5/ ... /DBCH25
Disco Bumper gommato con
foro diametro mm. 50
per bilanciere olimpionico
disponibile nelle
seguenti grammature:
Kg.5 - 10 - 15 - 20 - 25
Bumper Weight Plate
hole 50 mm. covered with rubber



Art. DGG-TRG
Disco in ghisa gommato tri grip
foro diametro mm. 50 per
bilanciere olimpionico
disponibile nelle seguenti grammature:
Kg.1,25 - 2,5 - 5 - 10 - 15 - 20 - 25
Tri grip cast iron Weight Plate
hole 50 mm. covered with rubber



Art. 13382 / 13383 / 13384 / 30937

Paio Cavigliere Kg. 0,5 - 1 - 1,5 - 2 cadauna
Pair of Ankle Weights 0,5 - 1 - 1,5 - 2 Kg. each one



Art. AHF-093

Paio Cavigliere Kg. 2,5 cadauna con pesi estraibili
Pair of Ankle Weights 2,5 Kg. each removable weights



Art. 17222

Cintura Body Building - misure da XS a XL
Body Building Leather Belt - sizes from XS to XL



Art. AHF-074
Coppia sostegni ruotabili per flessioni
Turnable Push-up handles

pg.12

pg.13



Art. AHF-026

Coppia maniglie per flessioni
Push-up handles



Art. AHF-047
Ruota doppia per addominali
Double Wheel for abdominal muscles



Art. AHF-070
Estensore con elastici
Chest-Expander

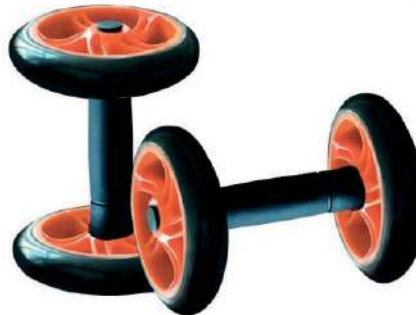

Art. AHF-157
Coppia manubri con ruote per addominali
Pair of dumbbells with wheels for abdominal muscles



Art. AHF-161

Coppia Parallettes h. cm. 75
Pair of Parallettes 75 cm. height



pg.14

Art. AHF-064
Contapassi multifunzione
Multi-function Step Counter



Art. 17203
Paio guanti Lycra
misure da XS a XL
Gym Gloves Lycra



Art. 30907
Paio guanti Premium Pro
misure da S a XL
Gym Gloves Premium Pro



Art. AHF-021
Coppia Tenaglie stringimano con impugnatura soft touch
Pincers for hand strengthening



Art. DEAPWR

Ministepper a pistoni idraulici con elastici per il potenziamento di braccia, dorso e addome
Computer a 2 funzioni: tempo, calorie
Peso massimo utilizzatore 100 kg.
Ministepper with hydraulic rams and elastic bands for strengthening arms, back and abdomen

pg.13

Art. OCST
Gradino step a 2 altezze (cm. 10-15)
con antiscivolo dim. cm. 68x30
Step adjustable at 2 different heights
(10-15 cm.) with anti-skid dim. 68x30 cm.



pg.14

Art. WBX-70

Power Tower

Attrezzo multifunzione ideato per l'allenamento intensivo di tutto il corpo senza l'utilizzo dei pesi
Tubolare a sezione quadrata da 5 cm.
Peso massimo utilizzatore 120 Kg.

Multi purpose tool for intensive body training without weights



Art. AHF-003

Gradino step regolabile a 3 altezze (cm. 15-20-25)
con superficie antiscivolo dim. cm. 89x39
Step adjustable at 3 different heights
(15-20-25 cm.)
with anti-skid surface dim. 89x39 cm.



Art. BTM

Barra per trazioni
con fissaggio a parete
Exercise Bar

pg.13



Art. BTE
Barra Entroporta
Door Bar



Art. CGF350
Panca multifunzione
telaio in acciaio,
schienale regolabile
portata massima kg. 100
Weight lifting Bench



Art. CGF450
Panca pesi con supporti
bilanciere, telaio in acciaio,
schienale regolabile
peso max utilizzatore kg. 100
Weight lifting Bench
with barbell holders

ATTENZIONE: questi prodotti sono concepiti esclusivamente per uso home fitness, perciò la garanzia non copre il loro utilizzo presso palestre o centri sportivi



Art. WBX-85
Panca piana/90° Power Bench
rinforzata (abbinabile con Power Rack)
Power Bench

pg.14



Art. GYM1000
Stazione Multifunzione
dotata di torre per dorsali, pressa per
pettorali, attrezzo per le gambe, vogatore,
cuscino per bicipiti - carico massimo 60 Kg.
(pesi inclusi), 15 esercizi praticabili
peso massimo utilizzatore 120 Kg.
Multi purpose machine



Art. WBX-50
Power Rack
Supporti per bilanciere
altezza e larghezza
regolabili
dotato di 2 rimessaggi
per dischi
peso massimo
caricabile 200 Kg.
Barbell racks

Art. ERX-65

Ellittica con manubrio
e poggipiedi regolabili
Sistema frenante magnetico
8 livelli di intensità con
regolazione manuale
Pulsazioni Hand Pulse
Schermo LCD
Funzioni: tempo, velocità,
distanza, pulsazioni, scan,
calorie, odometro
Peso massimo utilizzatore 110 Kg.
Peso del volano 8 Kg.
Elliptical exercise Bike
7 function computer

New!



pg.14

ATTENZIONE: questi prodotti sono concepiti esclusivamente per uso home fitness, perciò la garanzia non copre il loro utilizzo presso palestre o centri sportivi



Art. AB-CNH

AB Crunch Master richiudibile
AB Crunch Master foldable

Art. GBX-100

Panca ad inversione
massima portata Kg.120
Rotazione schienale su 3 livelli
predefiniti (20° - 40° - 60°)
e rotazione libera - regolabile per
altezza utente da cm. 147 a 198
dim. cm. 73x159x155/212
Inversion bench
maximum load 120 kg.
Backrest rotation on
3 inclinations (20° - 40° - 60°)
and free rotation
adjustable for user height
from 147 cm. to 198 cm.
dim.cm.73x159x155/212



Art. WBK-100

Panca per addominali
massima portata Kg.110
dimensioni cm. 126x31x31
Abdominal bench
maximum load 110 kg.
dimensions 126x31x31 cm.



pg.13

Art. GWM13

Pedaliera manuale utilizzabile da seduti per gli
arti inferiori e appoggiata sul tavolo per gli arti
superiori, peso 5 Kg. - con computer
Intensità sforzo regolabile
Cycling device for arm and leg exercises



Art. GWE13

Pedaliera elettrica per la ginnastica passiva
degli arti inferiori e superiori, velocità regolabile
con telecomando, peso 6 Kg. - con computer
Cycling electric device for arm and leg exercises



Art. BFK-350

Bicicletta da camera con freno magnetico
Regolazione dell'intensità manuale a 8 livelli
Volano da 4 Kg. - Computer a 6 funzioni:
tempo, velocità, distanza, calorie, scan,
pulsazioni con sensori Hand Pulse
Peso massimo utilizzatore 100 Kg.
Peso dell'attrezzo 15 Kg.
Cyclette Magnetic with 6 function computer

ATTENZIONE: questi prodotti sono concepiti esclusivamente per uso home fitness, perciò la garanzia non copre il loro utilizzo presso palestre o centri sportivi

pg.13



Art. BRX-75

Bicicletta da camera con freno magnetico
Regolazione dell'intensità manuale a 12 livelli
Volano da 9 Kg. - Computer a 7 funzioni:
tempo, velocità, distanza, calorie, RPM, scan,
pulsazioni con sensori Hand Pulse
Peso massimo utilizzatore 110 Kg.
Peso dell'attrezzo 25 Kg.
Cyclette Magnetic with 7 function computer



Art. BRX-RC

Bicicletta da camera BRX-R 65 COMFORT
con freno magnetico e sedile con schienale
Regolazione dell'intensità manuale a 8 livelli
Volano da 7 Kg.
Computer a 7 funzioni: tempo, velocità, distanza, calorie,
pulsazioni con sensori Hand Pulse, odometro, scan
Peso massimo utilizzatore 110 Kg.
Peso dell'attrezzo 29,5 Kg.
Cyclette Magnetic with 7 function computer,
seat adjusting system



Art. 18220
Coprisedella spinning
Seat cover
for spinning bike

pg.14



Art. SRX60

Spinning Bike
SRX60 EVO
con volano da 20 Kg.
Trasmissione a cinghia
con pignone fisso
Sistema di frenaggio
a tampone con feltri
Computer con LCD
(velocità, tempo, distanza, calorie,
odometro, pulsazioni)
Sella regolabile in
orizzontale ed in altezza
Manubrio regolabile in altezza
con appoggio per l'avambraccio
Portaborraccia
Peso massimo utilizzatore 125 Kg.
Peso dell'attrezzo 41 Kg.
Cyclette Magnetic with
seat and handle-bar
adjusting systems



**Senza motore.
Adatto per camminare,
non per correre**
With no engine. Suitable for
walking, not to run

Art. TFK-MAG
TAPIS ROULANT MAGNETICO TFK-SLIM-MAG
piano di corsa cm.38x102
sistema di frenaggio magnetico su 8 livelli
doppio volano Kg.6 - peso massimo
utilizzatore Kg.100 - display LCD con velocità,
frequenza cardiaca, distanza, tempo,
consumo calorico, scan, rilevazione cardio Hand Pulse
Tapis roulant magnetic with no engine,
with multi function computer



Art. TFK-230
TAPIS ROULANT TFK-230
motore 1,75/2,75 HP DC - velocità 1-14 Km/h
inclinazione manuale - piano di corsa cm. 42x121
peso massimo utilizzatore 100 Kg.
1 programma libero, 64 preimpostati, display LED
con velocità, frequenza cardiaca, distanza,
tempo, consumo calorico, programma in esecuzione
Tapis roulant with 1,75/2,75 hp engine and
multi program computer

ATTENZIONE: questi prodotti sono
concepiti esclusivamente per uso
home fitness, perciò la garanzia
non copre il loro utilizzo presso
palestre o centri sportivi

pg.14



Art. TFK-495
TAPIS ROULANT TFK-495 SLIM - salvaspazio
motore 2,25/3,25 HP DC - velocità 0,8-16 Km/h
inclinazione elettrica - piano di corsa cm.43x135
peso massimo utilizzatore 110 Kg.
3 programmi liberi, 12 preimpostati, display LCD
con velocità, inclinazione, frequenza cardiaca
tramite Hand Pulse, distanza, tempo,
consumo calorico, programma in esecuzione
ricevitore wireless per fascia cardio integrato
Tapis roulant with 2,25/3,25 hp engine
and multi program computer

Art. TRXRC
Vogatore Rower Compact - display LCD
con numero vogate, calorie, tempo, scan
regolazione sforzo su 12 livelli
peso max utilizzatore 110 Kg.
Rower machine with computer



pg.14



Art. CPGAN

Polsiere con gancio per esercizi alla barra per una presa più sicura e stabile grazie al gancio in acciaio rivestito in neoprene che si posiziona sotto al palmo della mano

Wristbands with hook for bar exercises for a safer and more stable grip thanks to the neoprene-coated steel hook placed under the palm of the hand

Art. POLTA

Polsiere per trazioni dotate di anello e chiusura regolabile con velcro, estremamente resistenti e adatte a polsi di qualsiasi circonferenza

Wristbands for traction with ring and adjustable velcro closure, extremely durable and suitable for wrists of any size

pg.13



Art. CAVTA

Cavigliere per trazioni dotate di anello e chiusura regolabile con velcro - comode e resistenti, si adattano a caviglie di qualsiasi circonferenza Ideali durante gli allenamenti di ginnastica, fitness e potenziamento muscolare

Ankle straps for traction with ring and adjustable velcro closure, comfortable and durable, they fit ankles of any size - ideal for gymnastics, fitness and muscle strengthening workouts

Art. CIPT

Cuscino imbottito per bilanciere per eseguire lo squat in totale sicurezza e comodità diametro cm.8, lunghezza cm.40

Padded barbell cushion for performing squats with total safety and comfort diameter 8 cm, length 40 cm



Art. 1FSF

Piastra antitrauma cm.100x100 spessore mm.10 in gomma riciclata con granulo ultrafine per proteggere il pavimento durante l'allenamento con attrezzi facile da posare e da pulire, antimuffa, antibatterica

Antitrauma plate 100x100 cm thickness 10 mm in ultrafine-grain recycled rubber to protect the floor during equipment training easy to install and clean, mold-resistant, antibacterial



Art. AHF-165

Fascia da braccio porta smartphone
Arm smartphone holder

Art. E680

Bracciale porta oggetti in neoprene cm.14,5x8x2
Neoprene arm wallet



CASACCHE - Mesh Shirts



Art. 088-A

Casacca traforata fluo taglia adulto

Fluo pierced training bib adult size - colors as in the picture



Art. 088-B

Casacca traforata fluo per bambini fino a 9 anni

Fluo pierced training bib small size
(for children up to 9 years)
colors as in the picture



pg.16

Art. 088-D

Casacca traforata double-face fluo taglia adulto colori rosso/blu - giallo/arancio

Fluo pierced training bib double-face adult size
colors red/blue - yellow/orange



Art. GIL01

Gilet steward misura senior

colori giallo, arancio
Colors yellow, orange

PANTALONCINI - CALZE - GUANTI Shorts - Socks - Gloves

**** QUANTITÀ PER TAGLIA E COLORE MULTIPLA DI 5 PEZZI ****
Quantity by size and color multiple of 5 pieces



Art. MF01
Pantaloncino da allenamento
100% poliestere
taglie dalla 3XS alla XXL
Colori: royal, bianco, bordeaux,
verde, navy, rosso, nero
(quantità per taglia e colore
multipla di 5 pz.)
Shorts in polyester
size from 3XS to XXL
Colors: white, red, royal,
blue, black, brown, green
(quantity by size and color
multiple of 5 pieces)



Art. IS005
Paio calze calcio con piede
Taglie

Bimbo: 29-34
Ragazzo: 35-40
Uomo: 41-46

Colori: royal, giallo limone, bianco,
bordeaux, navy, rosso, nero, verde
Pair of soccer socks sizes: Kid, JR, SR
Colors: white, red, royal, blue, black,
brown, lemon yellow, green

pg.16



Art. E6000
Scaldacollo in pile
taglia unica regolabile
colore navy o nero
Neck warmer in pile
one size fits all



Art. IGUAS
Paio Guanti in acrilico
colore nero
misura junior e senior
con antiscivolo
Black acrylic Gloves
size junior and senior
anti-skid



Art. E6013
Berretto in acrilico
nero, navy
taglia senior
Winter Cap
size senior

TACCHETTI ED ACCESSORI PER SCARPE - Studs and Shoe accessories



Art. 265bis / 268bis / 270bis
Tacchetto alluminio conico
 mm. 14-17-19
 conf. 100 pz. per misura
 Conical aluminium Stud
 14-17-19 mm.
 100 piece pack



Art. BACSC
Blister 12 tacchetti in alluminio
conici con rondelle
 (8 x mm. 14 + 4 x mm. 17)
 12 piece pack conical aluminium
 studs with washers

pg.14

pg.15

Art. BACS
Blister 12 tacchetti in alluminio
conici senza rondelle
 (8 x mm. 14 + 4 x mm. 17)
 12 piece pack conical aluminium
 studs without washers



Art. 262/263/264/265/266/267/268/269/270
Tacchetto alluminio conico tornito
 mm. 11-12-13-14-15-16-17-18-19
 conf. 100 pz. per misura
 Milled conical aluminium Stud
 100 piece pack



Art. PR11 / PR17
Tacchetto alluminio conico tornito
punta rinforzata mm. 11-17
 conf. 100 pz. per misura
 (ad esaurimento scorte)
 Conical aluminium Stud
 reinforced tip 11-17 mm.
 100 piece pack
 (until available in stock)



Art. A11 / A13 / A15 / A17
Tacchetto alluminio conico tornito
Argentinos superleggero Serie A
 mm. 11-13-15-17
 Milled conical aluminium Stud
 ultra-light Serie A
 11-13-15-17 mm.



Art. AL09F / AL11F / AL13F / AL15F
Tacchetto alluminio conico tornito Argentinos superleggero Serie A
con filettatura maggiorata (Adidas) mm. 9-11-13-15
 Milled conical aluminium Stud ultra-light Serie A
 with increased thread (Adidas) 9-11-13-15 mm.



Art. 292 / 294 / 294bis

Tacchetto in nylon conico punta rinforzata in alluminio mm.11-15-17, conf. 100 pz. per misura (ad esaurimento)
Conical Nylon stud with reinforced tip - 100 piece pack (until available)

pg.15



Art. 231 / 232 / 233

Tacchetto in nylon punta rinforzata in metallo mm. 11-13-16 conf. 100 pz. per misura
Nylon stud with reinforced tip 11-13-16 mm. 100 piece pack

Art. 230

Blister 12 tacchetti in nylon punta rinforzata in metallo mm. 11-13-16
12 piece pack nylon studs with reinforced metal tip 11-13-16 mm.



Art. M204 / M205

Tacchetto in nylon monocolor mm. 13 / 16 conf. 100 pz. per misura
Nylon Stud mm. 13 / 16 - 100 piece pack



Art. M203

Blister 12 tacchetti in nylon monocolor 8 x mm. 13 + 4 x mm. 16 (nero, rosso, bianco)
12 piece pack nylon studs single color (black, red, white)



Art. 35M12

Tacchetto gomma base stretta mm. 12 conf. 100 pz.
Narrow Base Rubber Stud mm. 12 - 100 piece pack

Art. 35M14

Tacchetto gomma base stretta mm. 14 conf. 100 pz.
Narrow Base Rubber Stud mm. 14 - 100 piece pack



Art. 072.11.13

Confezione blister 12 tacchetti gomma base larga per terreni gelati (8 x mm. 11+ 4 x mm. 13)
Wide Base Rubber Stud - for icy ground 12 piece pack

Art. 302

Base filettata in alluminio mm. 7, 8 (mm.10, 12 ad esaurimento)
Threaded aluminium base 7, 8 mm. (10, 12 mm. until available)
conf. 50 pz. per misura - 50 piece pack



Art. 314 Rondella in alluminio - conf. 100 pz.

Aluminium washer - 100 piece pack



Art. 302G

Base filettata in alluminio mm. 17 (mm.13 ad esaurimento) - conf. 50 pz. per misura
Threaded aluminium base 17 mm. (13 mm. until available) - 50 piece pack



Art. CHAZ

Chiave in acciaio zincocromata
Stud Key



Art. 317 / 318
Paio tendiscarpe a molla,
misura 39-42 / 43-46
 Shoe stretchers with spring,
 size 39-42 / 43-46

● pg.15

● pg.16



Art. 326 / 326FL / 327 / 327FL / 328 / 328FL
Paio lacci per scarpe cm.120-150-180
colori nero, bianco, giallo fluo, verde fluo, arancio fluo
 Pair of shoe laces 120-150-180 cm. long
 colors: black, white, fluo yellow, fluo green, fluo orange



Art. SOL.SP
Paio solette in gel
profumate ritagliabili
 Gel Insoles



Art. ALZ.SP
Paio Alzatacco in gel
taglia 1 donna
taglia 2 uomo
 Gel under heel softeners
 woman and man sizes



Art. 21654
Paio solette
Spugna Sport
 Sport Insoles



Art. E6694
Paio Alzatacco in silicone
misura S (33/36) - M (37/40)
L (40/44) - XL (44/48)
 Silicone under heel softeners
 various sizes



Art. 238:1

Art. 238.1
Grasso Aquila Kg.1
Aquila Grease for shoes
1 Kg.



Art. 238

Art. 238
Grasso Aquila ml. 100
Aquila Grease for shoes
100 ml.

pg.15

Art. 34071A
Spray impermeabilizzante
Spray waterproofing



Art. D122X
Spray Dilato ml. 200 ammorbidente
Spray to soften leather
soccer shoes



Art. S489
Spazzola in setola naturale
Shoe Brush



Art. SL.S
Spugna lucidascarpe (ad esaurimento)
Shoe polisher sponge
(until available)



Art. TE.540.01
Zerbino pulisciscarpe in plastica con ventose
dimensioni cm.35x27
Shoe cleaning device
in plastic with suckers
dimension 35x27 cm.

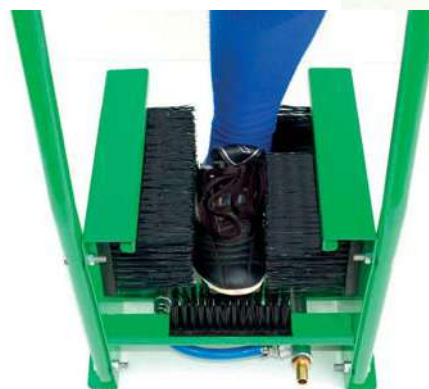

pg.16

Art. FA270
Macchina lavascarpe con 4 spazzole sostituibili
getti incrociati regolabili ad alta pressione
completo di poggiamani e 4 fori di fissaggio a terra
in dotazione fascetta in acciaio per collegamento tubo
mm. 15x21 (non incluso) alla rete idrica
Shoe washing device - high pressure crossed water jets
iron frame with handles, replaceable brushes
easy fixing to the floor with 4 holes



PARASTINCHI - GUANTI PORTIERE - Shinguards - GK Gloves



Art. PSCV
Paio parastinchi
senza cavigliera
misura adulto
e bambino
Pair of shinguards
without ankle protection
junior and senior size



Art. IS30HS
Paio parastinchi
senza cavigliera
misura S-M-L
Pair of shinguards
without ankle
protection
size S-M-L

pg.16



Art. PBC
Paio parastinchi
con cavigliera
misura adulto
Pair of shinguards
with ankle protection
senior size



pg.16

Art. F30BG
Paio Guanti portiere misure da 4 a 11
Pair of Goalkeeper Gloves size from 4 to 11

I colori dei guanti raffigurati nelle immagini possono variare

FASCE CAPITANO - Captain's Armbands



Art. 150
Fascia capitano elastica
misura adulto
Elastic Captain's armband
size adult

Art. 150.B
Fascia capitano elastica
misura bambino
Elastic Captain's armband
size children

pg.17



Art. 150F Fascia capitano elastica
misura adulto colore giallo fluo
o arancio fluo
Elastic Captain's armband adult size
colors: fluo yellow and fluo orange



Art. 150V / 150V.B

Fascia capitano con velcro, taglia adulto / bambino
Modello Champions colori bianco, rosso, giallo, verde,
blu, fucsia, arancio - h. cm. 6,5
Captain's armband adjustable length
6,5 cm. height size adult / children
colors: white, red, yellow, blue, green, fuchsia, orange



Art. 150V.9

Fascia capitano con velcro, taglia adulto
colori: bianco, rosso, giallo fluo, verde,
blu e arancio fluo - h. cm. 9
Captain's armband adjustable length, 9 cm. height
size adult - colors: white, red, fluo yellow,
blue, green, fluo orange

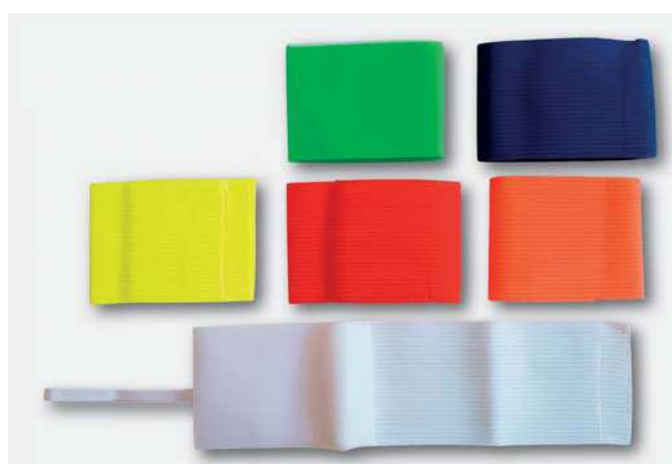

Art. 150V.9N

Fascia capitano neutra con velcro, taglia adulto
h. cm. 9 - colori: giallo fluo, arancio,
bianco, rosso, verde, blu
Captain's armband with no "C" printed adjustable
length, 9 cm. height size adult - colors: fluo yellow,
orange, white, red, green, blue



Art. 150N

Fascia nera lutto
Black mourning armband

Art. SB099

TUBOLARE BARRET in microfibra 108 dinari

Prodotto tecnico brevettato come modello d'uso CEE - Made in Italy

Lascia traspirare la pelle e ripara dal freddo e dal vento

utilissimo in molteplici situazioni:

**durante e dopo gli allenamenti, durante gli incontri,
per sostenere la tua squadra, nel tempo libero, in moto etc.**



**Prodotto
bi-elastico
senza cuciture
bi-elastic
seamless**

Barret TUBOLAR HAT in microfiber - made in Italy patented
BTH lets your skin breath while protecting you from cold and wind
you can wear it during or after training, during the game, in your spare time,
to support your team, when riding your bike etc.

pg.16

utilizzabile come scaldacollo, foulard, bandana, fascia, passamontagna etc.



it can change shape from neck warmer to head band to foulard to bandana



**A differenza del comune
prodotto in pile, la
microfibra del Tubolare
Barret impedisce il
surriscaldamento e
l'eccessiva sudorazione
della pelle, grazie
alla sua speciale
traspirazione e
leggerezza**



**PRODOTTO
TECNICO
TECHNICAL
PRODUCT**

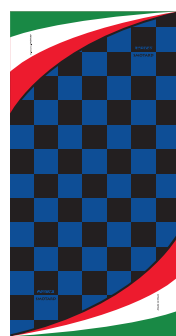
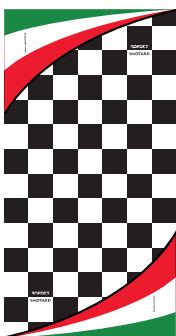

**Colori disponibili:
bianco/nero, nero/azzurro,
rosso/nero, bianco/celeste,
bianco/rosso, giallo/rosso
(prodotto personalizzabile su
richiesta per ordine minimo di
100 pezzi, con spese
per elaborazione grafica da
definire)**

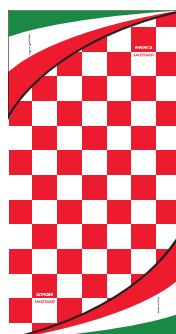
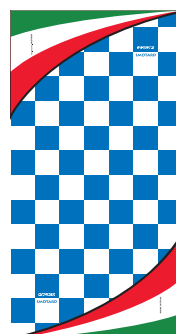
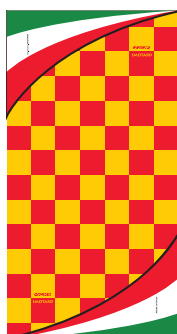

Colors available
as in the pictures
Barret tubolar HAT can be
personalized with your logo and
colors with a minimum order of
100 pieces (graphic work not
included in the price)

NUMERI TERMOSALDABILI Numbers for Uniforms

Colori disponibili: bianco, giallo, rosso, verde, royal, blu, granata, nero, oro, argento
Available colors: white, yellow, red, green, royal, blue, brown, black, gold, silver

Art. PN23



Art. PN18



Art. PN10



pg.17

Art. PN23

Numeri termosaldabili
Omega h. cm. 23
numeri singoli (da 0 a 9)
Single numbers for sport uniforms
Omega series 23 cm. height
(from 0 to 9)

Art. PN18

Numeri termosaldabili
Omega h. cm. 18
numeri singoli (da 0 a 9)
Single numbers for sport uniforms
Omega series 18 cm. height
(from 0 to 9)

Art. PN10

Numeri termosaldabili
Omega h. cm. 10
numeri singoli (da 0 a 9)
Single numbers for sport uniforms
Omega series 10 cm. height
(from 0 to 9)



TEMPERATURA
DI APPLICAZIONE 140/145 °C
TEMPO DI APPLICAZIONE
15 SECONDI
MAXIMUM TEMPERATURE 145 °C
MAXIMUM 15 SECOND PRINT

Art. PN4

Numeri termosaldabili Omega h. cm. 4
con cerchio (da 1 a 100)
colori bianco, blu o nero
Numbers for sport uniforms
Omega series 4 cm. height with circle
(from 1 to 100)
black, blue or white color

LAVAGNE TATTICHE PER CALCIO E CALCETTO - Tactical Boards for Football and Futsal

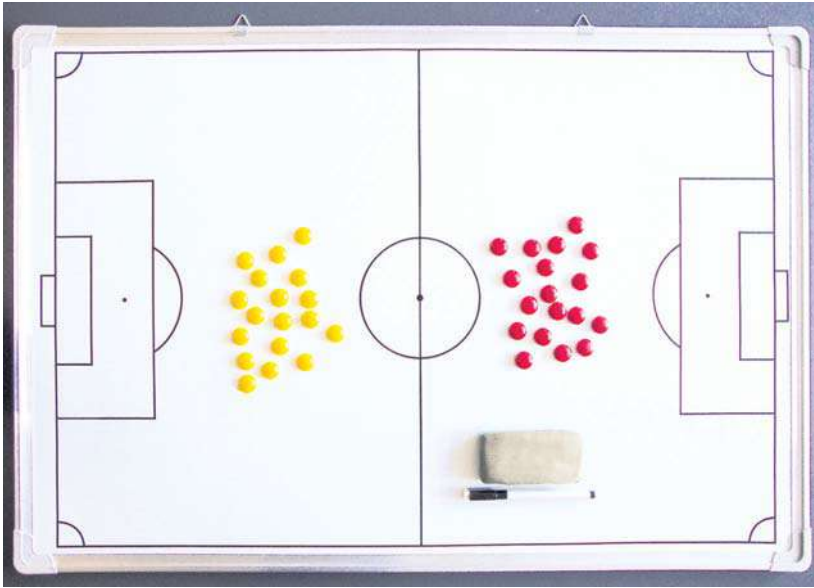

Art. 087
Lavagna magnetica cm. 60x90 cancellabile con cornice metallica

Tactical board 60x90 cm. magnetic and erasable with metal frame

Art. 087.BO

Borsa per lavagna Art. 087
Bag for tactical board Art. 087



Art. PM60

Serie pedine magnetiche di ricambio per lavagna Art. 087

Spare magnetic pieces for tactical board Art. 087

● pg.18



Art. M087TP

Treppiede di sostegno in acciaio verniciato per lavagna Art. 087 (lavagna esclusa)

Painted steel tripod for tactical board Art. 087 (board not included)



Art. 090

Lavagna su treppiede con 100 fogli cm.70x100 (non cancellabili)

Board on tripod with 100 sheets 70x100 cm. (not erasable)

Art. 090RIC

Ricambio 100 fogli cm.70x100 per lavagna Art. 090 (treppiede escluso)

100 spare sheets for board Art. 090 (tripod not included)

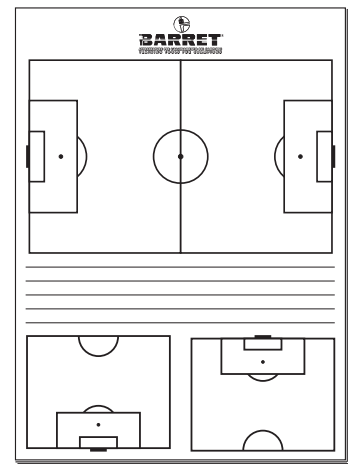

Art. BL50F

Blocco con 50 fogli formato A4 (non cancellabili)

Block with 50 A4 sheets (not erasable)

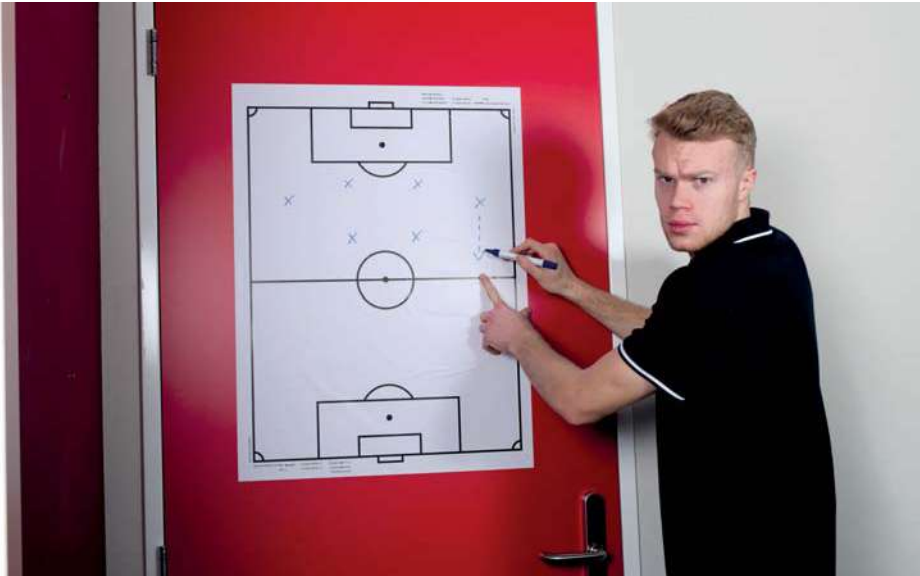

Art. 05030425

Set 25 fogli adesivi cm.80x100 applicabili a porte e pareti, rimuovibili e cancellabili (ideale per partite in trasferta)
 Set of 25 adhesive sheets 80x100 cm. on a roll, easily separable. Due to the electrostatic charge, it can be hung on any door or wall and removed several times without leaving any trace. Ideal for away games. Either permanent or non permanent markers work for writing

● pg.18



Lato A
Side A



Lato B
Side B

Art. 089

Lavagna magnetica bifacciale cancellabile con borsa cm. 45x30
 2 face Tactical Board magnetic and erasable 45x30 cm. with bag

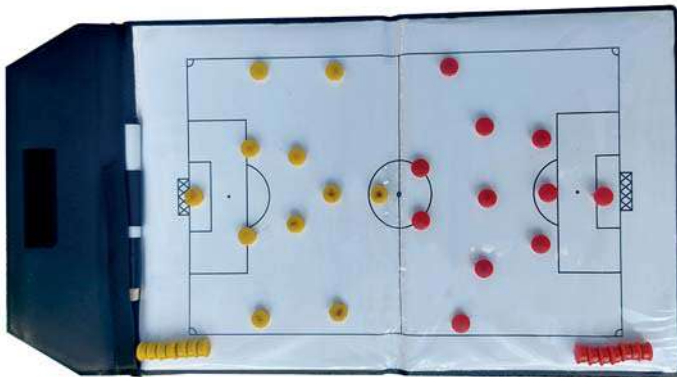

Art. 089-P
Lavagna magnetica cancellabile pieghevole cm. 46x25
 Foldable Tactical Board magnetic and erasable 46x25 cm.

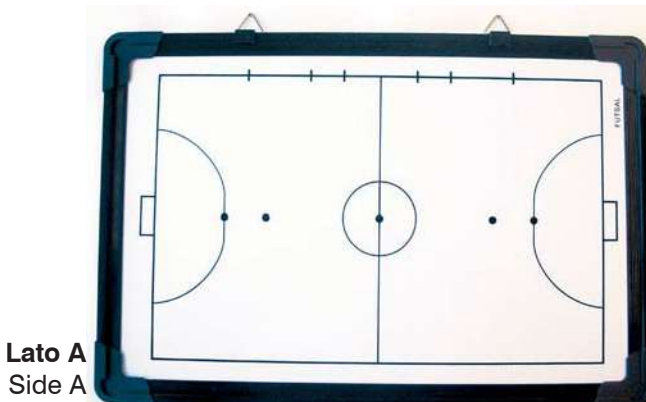

Lato A
Side A

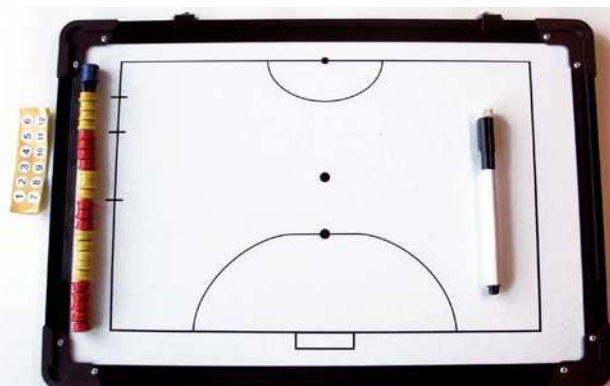

Lato B
Side B

Art. 089CM

Lavagna Tattica Calcio bifacciale magnetica e cancellabile cm. 45x30
 2 face Futsal Tactical Board magnetic and erasable 45x30 cm.

● pg.18

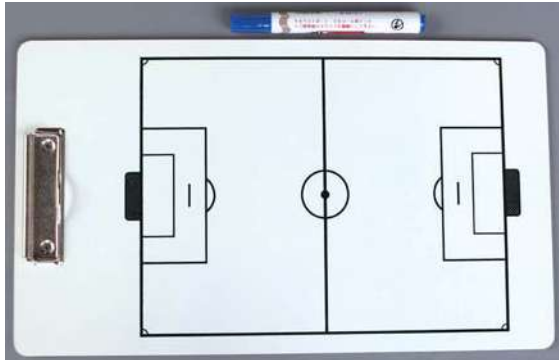

Art. 089-A
Lavagna bifacciale cancellabile cm. 40x23
 2 face Tactical Board erasable, 40x23 cm.



Art. CSRK
Lavagna Tattica magnetica cancellabile
con block-notes cm. 40x23
 Magnetic Tactical Board 40x23 cm. erasable

● pg.18

● pg.18

Art. 089-C
Lavagna Tattica
Calcetto bifacciale
cancellabile
cm. 40x23
 2 face Futsal
 Tactical Board 40x23
 cm. erasable

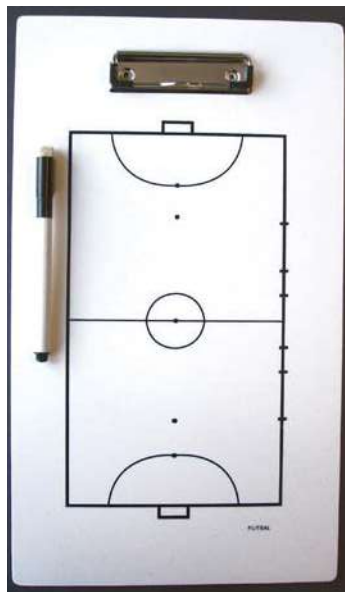

Art. PM
Serie pedine magnetiche
di ricambio per lavagne
di dimensioni ridotte
 Spare magnetic pieces
 for small tactical boards

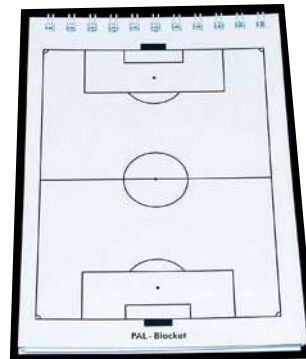

Art. PAL-B
Pal Block - blocco
tascabile con 25 pagine
copertina cancellabile
 Pocket block-notes
 25 pages with erasable cover

● pg.18



Art. 18330
Lavagna magnetica cancellabile pieghevole
Multisport (Calcio, Basket, Volley, Rugby,
Badminton, Tennis, Floorball, Pallamano,
Hockey su ghiaccio)
dimensioni cm. 32x22
 Multisport Foldable Tactical Board magnetic and
 erasable 32x22 cm.

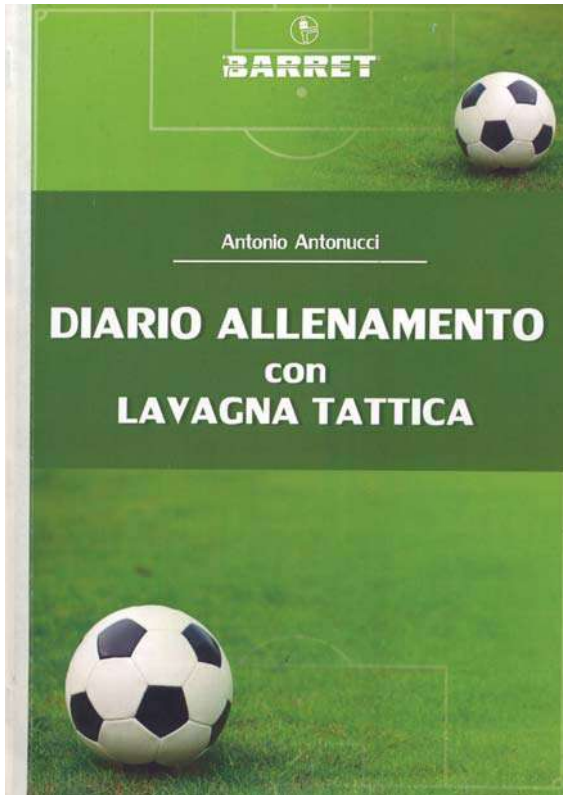

Art. DALT

DIARIO ALLENAMENTO

per l'allenatore di calcio con lavagna tattica

Lo strumento ideale per programmare e registrare durante il corso della stagione tutto ciò che riguarda la preparazione fisica generale, specifica e speciale, i test di valutazione, la preparazione psico-tattica teorica e pratica, la preparazione psico-cinetica, gli esercizi tecnico-tattici, il riscaldamento, il defaticamento e la preparazione post-infortunio della Vostra squadra di calcio e dei singoli giocatori che la compongono. E' inoltre fondamentale per l'annotazione di tutto ciò che riguarda le partite amichevoli e le partite di campionato, in relazione agli avversari da incontrare.

Il diario è corredato di una retrocopertina pieghevole utilizzabile come lavagna tattica cancellabile a 3 facce

140 pagine

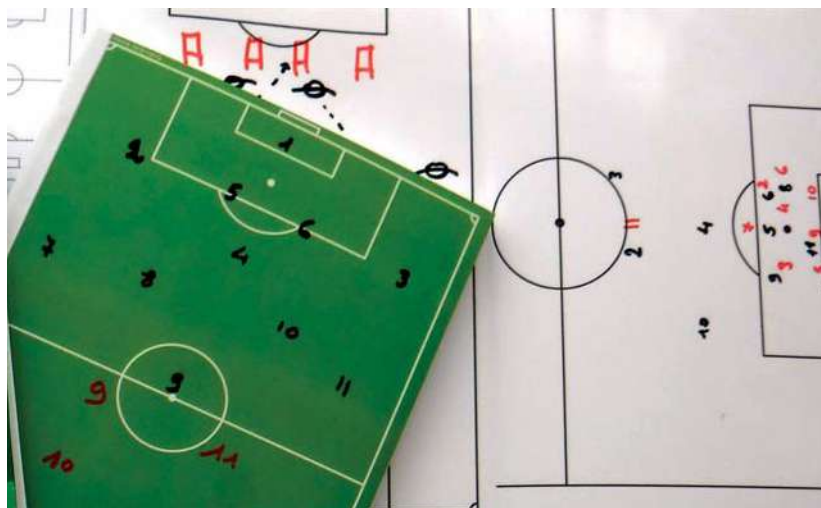

pg.18

Con lavagna cancellabile sulla retrocopertina



GHIACCIO - TAPE - CREME - OLI
Ice - Tape - Creams - Oils



Art. 164
Ghiaccio spray
ml. 400
Ice spray 400 ml.



Art. 165
Ghiaccio
in busta monouso
Ice in envelope

pg.17

pg.18



Art. JB08

Nastro economico cm. 2,5x10 mt
Tape cm. 2,5x10 mt.

Art. JB06

Nastro economico cm. 5x10 mt
Tape cm. 5x10 mt.

Art. N2.5

Nastro tipo Strappal cm. 2,5x10 mt
Tape Strappal cm. 2,5x10 mt.

Art. N5

Nastro tipo Strappal cm. 5x10 mt
Tape Strappal cm. 5x10 mt.



Art. NC3820

Nastro adesivo colorato fermacalze
cm. 3,8x20 mt.
colori: rosso, nero, blu, verde e giallo
Coloured Tape stop stockings
in red, black, blue, green and yellow



Art. 9254
Salvapelle
Skin Protection

pg.18



Art. K02
Fitoplast cm. 7,5x4,5 mt.
benda adesiva di supporto
Adhesive support bandage



Art. T255
Kinesio Tape
Kinesio Tape



Art. P127
Forbici per bendaggi
in acciaio inox
Scissors for taping



Art. BS0211
Olio canforato
riscaldante 500 ml.
stimola la circolazione,
tonifica la muscolatura,
previene le lesioni muscolari
microtraumatiche
 Oil 500 ml.
 for muscle warm up, stimulating
 blood circulation
 and preventing micro injuries

pg.18



Art. BS0219
Crema riscaldante
pregara 250 ml.
stimola la circolazione,
tonifica la muscolatura,
previene le lesioni muscolari
microtraumatiche
 Cream 250 ml.
 for muscle warm up, stimulating
 blood circulation and preventing
 micro injuries



Art. BS0227
Crema vaselina filante 250 ml.
per curare le zone della pelle
a maggiore sollecitazione
 Vaseline 250 ml. avoiding
 skin problems



Art. P123
Fango marino 100 ml.
per impacchi dopo distorsioni,
per assorbimento ematomi
 Special mud 100 ml. to be
 used after injuries
 (i.e. sprained ankles)
 and to absorb bruises



Art. BS0229
Cream-Gel 100 ml.
coadiuvante per
infiammazioni, contusioni
e lesioni dell'apparato
muscolare
 Cream-Gel 100 ml.
 for treating minor injuries
 and sore muscles

Art. P128
Gel rinfrescante
100 ml.
refrigerante
immediato su
contusioni
o strappi muscolari
 Cooling gel 100 ml.
 for immediate
 application on
 bruises and sore
 muscles



Art. T17G
Cuscinetto
in gel
dim. cm.27x12
(effetto freddo
ed effetto caldo)
 Gel Pillow
 27x12 cm.
 (both for cold
 and hot therapy)



pg.17

BORRACCE - Water Bottles



Art. K8
Borraccia da 1 litro
in plastica
1 liter plastic Water Bottle

pg.17

Certificate
per uso
alimentare
Food grade
certified



Art. B500ML
Borraccia
da ½ litro
in plastica
½ liter plastic
Water Bottle



Art. BAL1
Borraccia da 1 litro
in alluminio
1 liter aluminium Water Bottle



Art. BAL05
Borraccia da ½ litro
in alluminio
½ liter aluminium Water Bottle

Certificate
per uso
alimentare
Food grade
certified



Art. BTA05
Borraccia termica
da ½ litro in acciaio
mantiene costante la temperatura
del liquido (sia caldo che freddo)
½ liter thermic steel Water Bottle
keeps the liquid temperature
unchanged



Art. IRTT
Distributore termico 6 litri
con rubinetto
Thermos 6 liter with tap



Art. 308.C
**Cestello per 6 Borracce
in plastica**
Holder for 6 plastic
water bottles

pg.17



Art. 306
**Kit 6 Borracce
da 1 litro in plastica con cestello**
Kit 6 one liter plastic water bottles
with holder



Art. C6B
**Cestello per 6 Borracce
in plastica pieghevole**
Foldable Holder for 6
plastic water bottles



Art. KIT6
**Kit 6 Borracce da 1 litro
in plastica con cestello pieghevole**
Kit 6 one liter plastic water bottles
with foldable holder



Art. OC8
**Cestello per 8 Borracce
in plastica pieghevole**
Foldable Holder for 8
plastic water bottles



Art. K8S6
**Kit 8 Borracce
da 1 litro in plastica
con cestello pieghevole**
Kit 8 one liter plastic water bottles
with foldable holder

BANDIERINE - Flags



Art. 074
 Kit completo
 4 paletti
 calcio d'angolo
 con snodo
 in PVC Ø mm.32
 (bandierine colore
 giallo o rosso)
 Kit 4 complete
 flexible Corner
 Poles
 in PVC Ø 32 mm.
 (yellow or red flags)



Art. 074RP
 Kit completo
 4 paletti
 calcio d'angolo
 con snodo
 rinforzati con tubo
 esterno in
 polipropilene
 Ø mm.40
 (bandierine colore
 giallo o rosso)
 Kit 4 complete
 flexible Corner
 Poles reinforced
 with polypropylene
 pipe Ø 40 mm.
 (yellow or red flags)

pg.18



**Non utilizzabili
 per partite ufficiali**
 Not for official
 matches

Art. 073
 Kit completo
 4 paletti calcio d'angolo
 in PVC Ø mm.32
 (bandierine colore giallo o rosso)
 Kit 4 complete Corner Poles
 in PVC Ø 32 mm.
 (yellow or red flags)



Art. 368

Art. 368 Kit ricambi
 4 Bandierine calcio d'angolo
 colore giallo o rosso
 Kit of 4 spare Corner Flags
 yellow or red color



Art. 075



Art. 076

Art. 075 / 076

Coppia Bandierine segnalinee gialle / a scacchi con aste in plastica
Pair of linesman's Flags yellow / checked with plastic sticks

● pg.18

● pg.19



Art. 367-G

Art. 367-S

Art. 367-G / 367-S

Kit ricambi 2 Bandierine segnalinee gialle / a scacchi
Kit of 2 spare linesman's Flags yellow / checked



Art. 13ALC

Coppia Bandierine segnalinee a scacchi fluorescenti con aste in alluminio e custodia
Pair of linesman's Flags fluorescent with aluminium sticks and holder



● pg.19

Art. 172

Coppia Bandierine segnalinee elettroniche complete di ricevitore e borsa
Pair of electronic linesman's Flags complete with signal receiver and bag

ACCESSORI ARBITRO - Referee's accessories



Art. 078
Fischio FOX 40 Classic senza pallina
nero o colorato
Whistle FOX 40 Classic

Art. 078PD

Fischio arbitro senza pallina
FOX 40 Classic CMG nero o
colorato con imboccatura
anatomica e cordino
Whistle FOX 40 Classic CMG
cushioned mouth grip
(cord is included)

pg.19



Art. 078SK

Fischio FOX 40 Sonik Blast
CMG con cordino - vari colori,
con due camere sonore
Whistle FOX 40 Sonik Blast
CMG with cord, various colors



Art. 078CH

Fischio senza pallina nero o colorato con cordino in confezione blister
Plastic whistle various colors with cord

pg.19



Art. 228C

Fischio in plastica
nero con cordino
Plastic black whistle
with cord

Art. 228

Fischio in plastica nero
senza cordino
Plastic black whistle
without cord



Art. 079C

Fischio cromato
con cordino
Chromed brass
whistle with cord

pg.19



Art. FEFOX

Fischio elettronico
FOX 40 con cordino
potenza 100 dB
Electronic FOX 40
whistle with cord



Art. 080
Cordino Lanyard
colore nero
Nylon
whistle cord Lanyard
black color

pg.19



Art. F40CAP
Cordino FOX antipanico
regolabile, vari colori
FOX whistle cord adjustable
various colors



Art. 9816
Laccino regolabile
per fischietto arbitro
Adjustable wrist lace
for referee's whistle



Art. KCPFOX
Kit cronometro da polso e
fischietto FOX 40 Sonik Blast
con cordino
Kit wrist Chronometer with FOX
40 Sonik blast whistle with cord



Art. RPC
Raccogliatore ad anelli cm.18x15
per cartellini giocatori
con 20 buste trasparenti
Ring binder 18x15 cm. for players'
cards with 20 transparent envelopes



Art. 081F Coppia cartellini
giallo e rosso con custodia,
matita e tabellino gara
Yellow and red cards with holder,
pen and game note card

Art. RPCRIC
Ricambio 10 buste trasparenti per
raccogliatore ad anelli Art. RPC
Set of 10 spare envelopes for Art. RPC



Art. ZAFN
Tabellino gara di ricambio
per Art. 081F
Spare game note card for Art. 081F



Art. GR15
Coppia cartellini
giallo e rosso
riscrivibili con pennarello
cancellabili con alcol
(ad esaurimento)
Rewritable yellow
and red cards with pen
erasable with alcohol
(until available)

pg.19

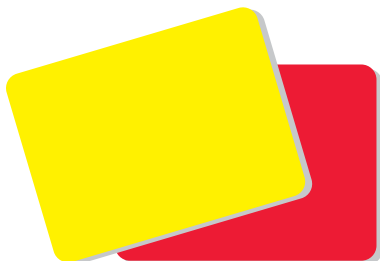

Art. RYC02
Set 1 cartellino arbitro giallo
e 1 cartellino arbitro rosso
Set 1 yellow and 1 red card for referee



Art. RCB
Cartellino arbitro blu
Blue referee card



Art. 880147
Moneta per arbitro calcio
in metallo dorato
Referee's coin

COMPRESSORE - POMPE Inflator - Pumps



Non tenere in marcia il compressore per più di 5 minuti. Dopo, spegnerlo e lasciarlo raffreddare per almeno 5 minuti
Do not run the compressor for more than 5 minutes. Then, turn it off and let it cool for at least 5 minutes

Art. 106
Compressore elettrico 220 Volt con borsa
Electric Inflator 220 Volt with bag

pg.19

Art. 104-A
Pompa con ago
Pump with needle



Art. 2005
Confezione 12 Aghi con valvola per gonfiatura palloni Ø filettatura mm.5
Set 12 Needles with valve for inflating balls Ø 5 mm. thread

pg.19

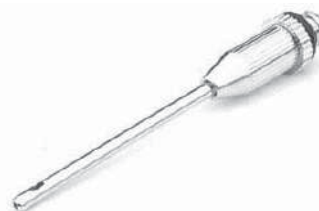

Art. 2005RC
Ago di ricambio per compressore Art. 106 Ø filettatura mm.7,5
Spare needle for electric inflator Art. 106 Ø 7,5 mm. thread



Art. PSS
Pompa a staffa
All purpose Pump



Art. 104-T
Pompetta in gomma soft con ago e valvola di sfiato ideale per gonfiatura palloni in gomma
Soft Pump with needle and valve for inflating rubber balls



MANOMETRI - CRONOMETRO - ROTELLE METRICHE - CONTAMETRI Gauges - Chronometer - Measuring Tapes - Meter Counter



Art. 107
Manometro misura pressione palloni con valvola (con indicazione pressioni consigliate per vari sport)
Pressure Gauge with valve (with indication of pressure for different sport balls)



Art. CRN.E
Cronometro digitale 1/100 sec.
Digital Chronometer 1/100 sec.



pg.19

Art. US107
Manometro misura pressione palloni alta precisione con valvola (con indicazione pressioni consigliate per vari sport)
High precision pressure Gauge with valve (with indication of pressure for different sport balls)



Art. CMT Contametri fino a m. 9999
Meter Counter until 9999 m.



Art. PR30
Rotella Metrica in fibra m. 30
Fiber measuring tape 30 m.

Art. PR50
Rotella Metrica in fibra m. 50
Fiber measuring tape 50 m.

Art. PR100
Rotella Metrica in fibra m. 100
Fiber measuring tape 100 m.

SEGNALATORI MANUALI ED ELETTRONICI PER SOSTITUZIONI Manual and electronic Substitution Boards

Art. 071
Serie numeri
cambio giocatori
(da 1 a 25)
senza manico
Numbers for substitution
(from 1 to 25)
without handle



Art. 072
Serie numeri cambio
giocatori (da 1 a 25)
con manico
Numbers for substitution
(from 1 to 25)
with handle



pg.19

Art. E6230
Segnalatore bifacciale
economico per cambio
giocatori manuale cm.43x38
Substitution indicator
1 piece 2 sides

Lato A
Side A



Lato B
Side B



Lato B
Side B

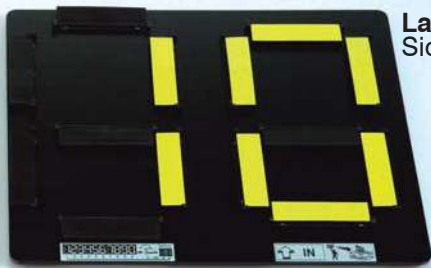
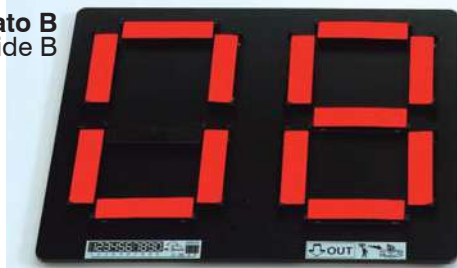

Lato A
Side A

pg.20

Art. C00937
Segnalatore bifacciale per
cambio giocatori manuale
fluorescente - cm.40x32
base in plastica lucida
Substitution indicator
fluorescent 1 piece 2 sides

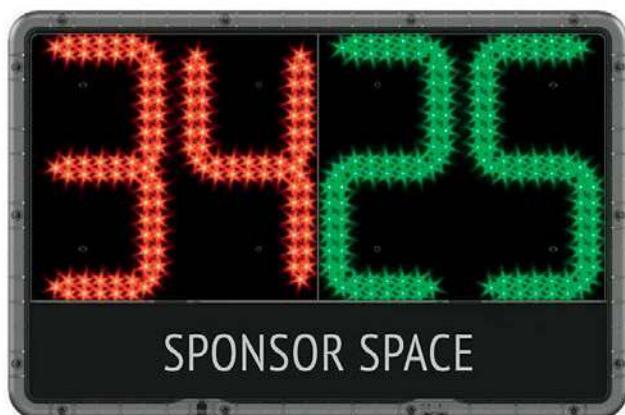

Art. F292-30
Valigetta cm. 61x40x8
per Art. FINOUT4 e FINOUT8
Case 61x40x8 cm. for Art. FINOUT4 and FINOUT8

Art. FINOUT4
Tavoletta elettronica bicolore, monofacciale
a 4 cifre (2+2) - led verdi per giocatore entrante
led rossi per giocatore uscente, completa di
caricabatteria - dim. cm. 58x38x2,7 kg. 2,2
4 Digit Electronic Substitution Board
1 side 2 color leds (red and green) 58x38x2,7 cm.
2,2 Kg. with battery charger

Art. FINOUT8
Tavoletta elettronica bicolore, bifacciale
a 4 cifre (2+2) - led verdi per giocatore entrante
led rossi per giocatore uscente, completa di
caricabatteria - dim. cm. 58x38x2,7 kg. 2,25
4 Digit Electronic Substitution Board
2 sides 2 color leds (red and green) 58x38x2,7 cm.
2,25 Kg. with battery charger

pg.20

Art. 065-EC

**Tavoletta elettronica bifacciale, bicolore
DELTA 2FE1 cm.46x33x1,8 Kg.1,5
completa di valigetta e caricabatteria**
4 digit Electronic substitution Board
2 sides - 2 color leds (red and green)
bag and battery charger included

UEFA
APPROVED

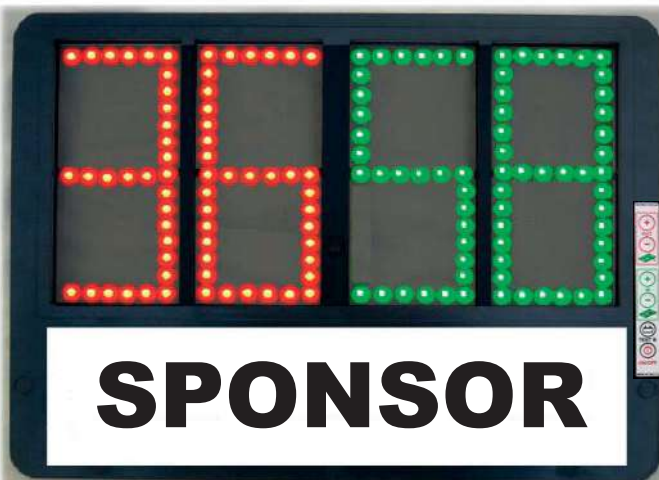

**Nuova tastiera
new keyboard**



pg.20

Art. D2FE

**Tavoletta elettronica
bifacciale, bicolore DELTA 2FE
completa di valigetta e caricabatteria**
cm. 64,5x39x2,5 kg. 2,8
4 digit UEFA Electronic substitution Board
2 sides - 2 color leds (red and green)
bag and battery charger included

UEFA
APPROVED

UEFA
APPROVED

Art. 065-F

**Tavoletta elettronica approvata UEFA/FIFA
bifacciale, bicolore a 4 cifre DELTA 2F
completa di valigetta e caricabatteria**
led rossi e verdi - cm. 64x39x3 kg. 3
4 digit UEFA/FIFA Electronic substitution
Board 2 sides - 2 color leds (red and green)
bag and battery charger included



MATERASSINI - Mats

Art. 044
**Materassino pieghevole
alta densità**
cm. 180x50x0,7
Folding foam Mat
high density
180x50x0,7 cm.

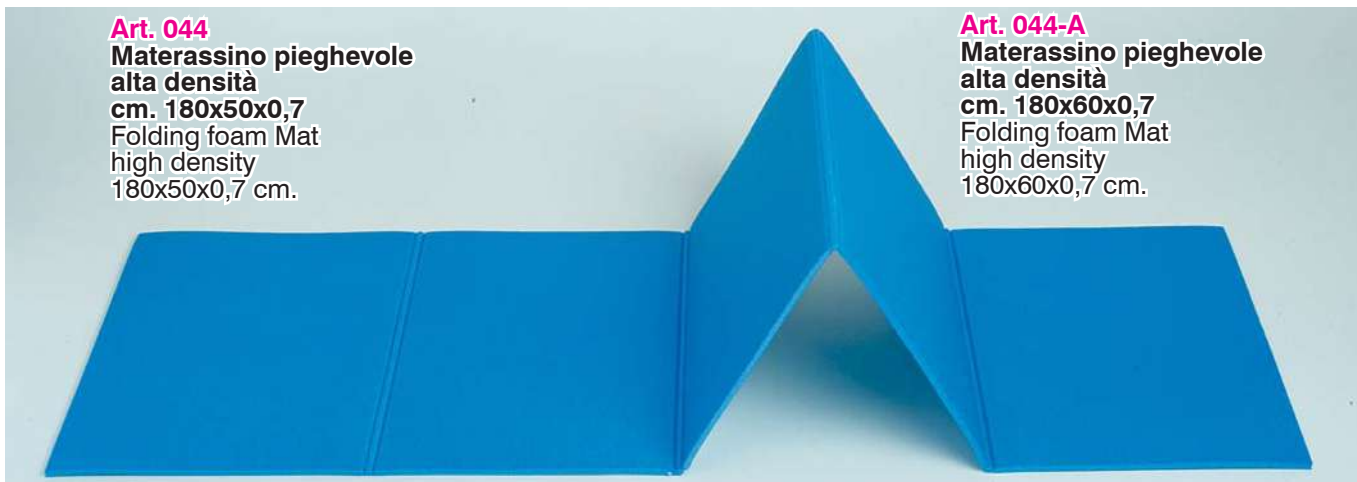

Art. 044-A
**Materassino pieghevole
alta densità**
cm. 180x60x0,7
Folding foam Mat
high density
180x60x0,7 cm.



Art. 044-R
Materassino arrotolabile alta densità cm. 180x50x0,6
Rolled foam Mat high density 180x50x0,6 cm.



pg.17

Art. MAT160
**Materassino arrotolabile blu
cm. 160x50x0,8 con maniglia
per il trasporto**
Rolled foam Mat
160x50x0,8 cm. with handle
for transport

New!



Art. AS803
**Materassino Exercise Mat
imbottito e serigrafato cm. 180x60x2,5**
PVC Mat 180x60x2,5 cm.



Art. 30924
**Materassino Yoga arrotolabile
cm. 172x60x0,4**
Rolled Yoga Mat 172x60x0,4 cm.

PALLONI CALCIO - Soccer Balls



Special Price



Art. GHYB3 / GHYB4 / GHYB5

Pallone calcio Gems Olimpico Academy da allenamento in PU BIC n. 3, n. 4 e n. 5 vari colori

Ball Gems in PU-BIK size 3, 4 and 5 various colors

Art. GPA4 / GPA5

Pallone calcio Gems Olimpico da allenamento in PU BIC n. 4 e n. 5 vari colori (ad esaurimento)

Ball Gems in PU-BIK size 4 and 5 various colors (until available)

Art. GPA4OT / GPA5OT

Pallone calcio Gems Olimpico Team da allenamento in TPU n. 4 e n. 5 (FIFA Basic) vari colori

Ball Gems in TPU size 4 and 5 various colors

pg.20



Art. 1000MS4 / 1000MS5

Pallone calcio da allenamento Molten misto TPU 1000MS n. 4 e n. 5 (Europa League replica) (ad esaurimento)

Molten training ball TPU size 4 and 5 (Europa League replica) (until available)



Art. F4N1000 / F5N1000

Pallone calcio da allenamento Molten TPU F4N1000/F5N1000 n. 4 e n. 5 Molten training ball TPU size 4 and 5



Art. GRPRO

Pallone calcio Gems Raptor Pro in microfibra da gara n. 5 FIFA Quality Pro
Gems match ball microfibre size 5



Art. F5V48TR

Pallone calcio Molten n. 5 F5V4800 "Trofeo" per allenamento professionisti e gare ufficiali categorie inferiori
Molten Soccer Ball F5V4800 "Trofeo" size 5

PALLONI CALCETTO, DA PALLEGGIO E SPECIALI - Futsal and rubber balls



Art. GBLD
Pallone calcetto Gems
Blade in TPU Soft
a rimbalzo controllato n. 4
Futsal Ball Gems size 4

pg.20



Art. GBLEL
Pallone calcetto da gara Gems
Blade Elite in PU Soft Hybrid
a rimbalzo controllato n. 4
Futsal Match Ball Gems size 4



Art. 26854
Pallone feltro indoor
n. 4 a rimbalzo normale
Indoor Ball size 4



Art. 45862
Pallone feltro indoor
n. 4 a rimbalzo controllato
Indoor slow rebound
Ball size 4

**Art. ULTST3/ULTST4/
ULTST5**
Palloni Trial SILVER
STREET n. 3 - 4 - 5
doppio strato
SILVER STREET Trial balls
size 3-4-5 double stratum



pg.21



Art. TRILO
Pallone calcio Trial
TRILO n. 4.5
doppio strato
limita il trauma dovuto
all'impatto con la palla
Soccer Ball Trial TRILO
size 4.5 double stratum
softens ball contact

RETI PORTAPALLONI - Ball sacs



Art. 041-6 / 041-12 / 041-18
Reti Portapalloni in polipropilene
senza nodo (da 6, 12 o 18 palloni)
Nets for balls in polypropylene
(for 6, 12 or 18 balls)



Art. S041-6 / S041-12 / S041-18
Reti Portapalloni in polipropilene
con nodo (da 6, 12 o 18 palloni)
Knotted Nets for balls
in polypropylene
(for 6, 12 or 18 balls)

pg.29

Art. SM20
Sacca Portapalloni
in nylon 420/PVC
capienza 20 palloni
Ball Sac for 20 balls





Art. 1935S
Pallone calcio in gomma
monostrato n. 3
colore giallo
Rubber soccer Ball
single stratum size 3
color yellow

● (pg.20)



Special Price

Art. V45 / V44 / V42 / V41 / V40
Palloni calcio in gomma Trial monostrato n. 1 - 2 - 3 - 4 - 5
(misura 5 solo nel colore bianco)
Rubber soccer Balls single stratum Trial size 1 - 2 - 3 - 4 - 5
(size 5 only in white color)



Special Price

Art. ULT42-3 / ULT41-3 / ULT40-3
Palloni calcio in gomma
Trial triplo strato
n. 3 - 4 - 5
Rubber soccer Balls
triple stratum Trial
size 3 - 4 - 5

● (pg.21)



Art. ULTS40

**Pallone in gomma Trial
allenamento potenziato doppio strato
Ø cm.21,5 - gr.630 (+50%)
Trial heavy rubber ball double stratum**



Art. ULTD40

**Pallone in gomma Trial
allenamento potenziato doppio strato
Ø cm.21,5 - gr.840 (+100%)
Trial heavy rubber ball double stratum**

pg.21



Art. TRBC

**Pallone Reaction Ball Trial
doppio strato rimbalzo e traiettorie
imprevedibili per calcio
(ad esaurimento)
Trial Reaction Ball double stratum
unpredictable rebounds for soccer
(until available)**



Art. B703316

**Reflex ball
pallone prismatico
in pelle sintetica
Prismatic ball in
synthetic leather**



Art. E44

**Pallone sonoro
Torball per calcio CIP
in gomma Trial
Ø cm.20,5 - gr.500
Trial rubber Torball**



pg.20

Art. 149S14

**Pallone in gommapiuma
Ø cm. 12
Foam rubber ball Ø 12 cm.**



Art. 149S

**Pallone in gommapiuma
Ø cm. 18,5
Foam rubber ball Ø 18,5 cm.**



pg.21

Art. E48

**Pallone sonoro Trial
per non vedenti
Ø cm.22 - gr.470
Trial rattle ball for blind people**

PALLE MEDICHE - Medicine Balls



pg.21

Art. AHF-105 / AHF-106 / AHF-107 / AHF-108 / AHF-109 / AHF-110

**Palle Mediche
rigonfiabili e rimbalzanti
kg. 1 - 2 - 3 - 4 - 5 - 6
ad alto grip colore nero
Medicine Balls
inflatable and rebounding
high grip in black color**



Art. 048 / 050 / 051 / 052 / 053

**Palle Mediche rigonfiabili
e rimbalzanti Trial
kg. 1 - 2 - 3 - 4 - 5
(il colore varia
a seconda del peso)
Trial Medicine Balls
inflatable and rebounding
different colors for different weights**



Art. DGMB3 / ... / DGMB10

**Palle Mediche
con maniglie
kg. 3 - 4 - 6 - 8 - 10
(kg. 2 ad esaurimento)
Medicine Balls
with handles**

pg.22

Art. AHF-048/.../AHF-097

**SLAM BALL
kg. 2 - 3 - 4 - 5 - 6 - 7 - 8 - 9 -
10 - 12 - 15**



pg.22



Art. AHF-224/.../AHF-232

**WALL BALL
kg. 3 - 4 - 5 - 6 - 7 - 8
9 - 10 - 12**



pg.13

Art. RVKEB
**Rastrelliera verticale
porta kettlebell/
palle mediche
(8 posti)
8-seater vertical rack
for cast iron
Kettlebells/
Medicine Balls**



Art. KEB4 / KEB6 / KEB8 / KEB10 / KEB12 / KEB16 / KEB20 / KEB24

**Kettlebell in ghisa verniciata con base in gomma
kg. 4 - 6 - 8 - 10 - 12 - 16 - 20 - 24
Painted cast iron Kettlebells - rubber base**



pg.22

Art. OV500 / OV1 / OV2 / OV3 / OV4 / OV5
**Over Ball Trial kg.0,5 - 1 - 2 - 3 - 4 - 5
con impugnatura anatomica
Over Ball Trial**



**Special
Price**



pg.22

**Art. WMD100 / WMD200
WMD300 / WMD400 / WMD500**
**Palle Mediche morbide Bubble
Trial - kg. 1 - 2 - 3 - 4 - 5
Soft Trial Medicine Bubble Balls
kg. 1 - 2 - 3 - 4 - 5**





Art. FLUIB05 / FLUIB1 / FLUIB2 / FLUIB3 / FLUIB4 / FLUIB5

Palle mediche FLUIBALL riempite con acqua demineralizzata colorata - peso kg. 0,5-1-2-3-4-5

pg.21 pg.22 FLUIBALL Medicine balls filled with demineralized coloured water - weight 0,5-1-2-3-4-5 Kg.

Grazie a queste nuove palle mediche gli atleti utilizzano carichi non inerti ma dinamici, effettuando esercizi di forza coordinata nuovi e destabilizzanti. La massa oscillante all'interno della palla medica FLUIBALL impone, sia in fase di lancio che di carico, adattamenti muscolari e coordinativi istantanei la cui intensità è variabile, e quindi non prevedibile. Inoltre, per i più giovani le palle mediche FLUIBALL sono molto efficaci per la memorizzazione della tecnica e per migliorare la conoscenza ed il controllo del proprio corpo. È possibile gonfiare e sgonfiare tutte le FLUIBALL variandone così la sofficietà

The new FLUIBALL medicine balls allow new exercises for muscle strength, equilibrium and coordination. The liquid inside these balls makes them dynamic weights that require new rapid and adapting movements both when throwing and when lifting. Younger players will also improve and memorize body movements enhancing their equilibrium. These balls can be inflated or deflated so that softness will change

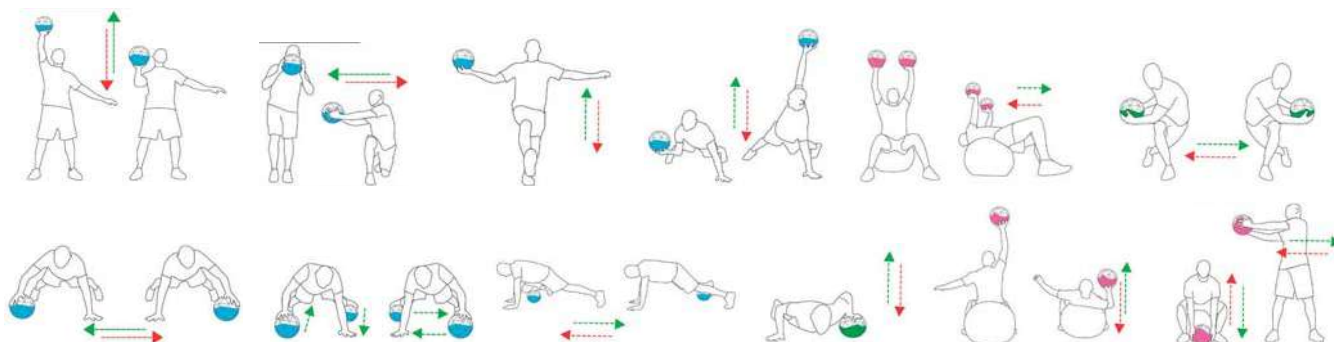

Con le palle mediche FLUIBALL è possibile effettuare un allenamento dinamico utile per il rafforzamento degli arti inferiori e superiori, e per migliorare l'abilità nel lancio e nella presa

With FLUIBALL you can run a dynamic training good for strengthening the lower and upper limbs, and to increase the ability of making throws and holds

Art. POL1 / POL1.5 / POL2 / POL3 / POL3.5

POLIBOLO - Over Ball Trial a massa oscillante (riempite con acqua distillata) peso kg.1 - 1,5 - 2 - 3 - 3,5

POLIBOLO - Over Ball Trial filled with distilled water - weights 1 - 1,5 - 2 - 3 - 3,5 Kg.

pg.22



Le Over Ball e le Polibolo possono essere utilizzate sia come manubri sia come palle mediche
Over Balls and Polibolos can be used both as dumbbells and medicine balls

PALLE PSICOMOTORIE E LUDICHE - Gym Balls



Art. 30934/30935/30936/31036

Palle psicomotorie monostrato

Gym balls single stratum

Ø cm. 55

Ø cm. 65

Ø cm. 75

Ø cm. 85

pg.22

**Ideali per trattamento
fisioterapico,
equilibrio, stretching,
tonificazione, attività
aerobica, scarico
vertebrale,
riscaldamento,
potenziamento
muscolare ...**

Very useful for injury
recovery, equilibrium,
stretching, muscle
training, aerobic activity,
warm up ...



**Art. V10/V11/V12/V13/V14/V15/
V16/V17/V18/V19**

**Palle psicomotorie Trial in
gomma doppio strato**

**(il colore varia
a seconda del diametro)**

Trial Gym balls
in double stratum rubber

Ø cm.14-18-22-30

42-53-65-90-120-150

pg.23



Art. V-LAB

**Palla psicomotoria Trial La Ball
con range di possibile utilizzo
da cm.50 a cm.70**

**struttura instabile in gomma doppio
strato particolarmente elastica**

Gym ball Trial La Ball
inflatable from 50 to 70 cm.

changing shape

in very elastic

double stratum rubber



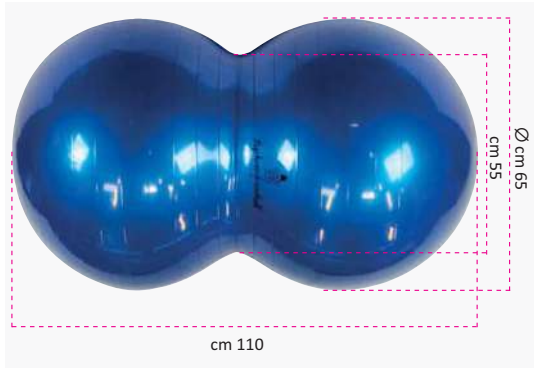

Art. TERV16
X-Ball Trial ø cm.65
X-Ball Trial ø 65 cm.



pg.23

Art. TERV14
X-Ball Trial ø cm.45
X-Ball Trial ø 45 cm.



Art. TERV12
Small Peanut Trial ø cm.35
Small Peanut Trial ø 35 cm.

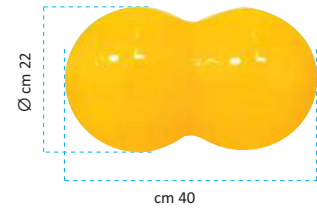

Art. TERV10
Small Peanut XS
Trial ø cm.22
Small Peanut XS
Trial ø 22 cm.

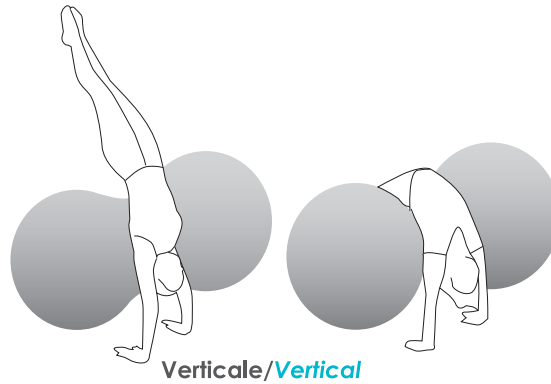

Capriola/Flip

Attrezzi polivalenti in gomma sintetica in doppio strato reticolato che consentono nuovi esercizi ideati per il consolidamento degli schemi motori, alla rieducazione e riabilitazione, alla ginnastica dolce. Nella riabilitazione sono uno strumento che dà sicurezza offrendo migliore stabilità agli esercizi. X-Ball in particolare, con il restringimento centrale che la rende in parte concava, può essere utilizzata anche per insegnare la capriola e la verticale in totale sicurezza.

Infatti, in ambito educativo, consente di effettuare esercizi a due bambini (lavoro di gruppo e socializzazione) o ad uno solo (cavalcioni) in assoluta sicurezza fisica e psicologica. Indispensabile anche nel trattamento fisioterapico per riscaldamento, stretching, tonificazione. Rigonfiabile e resistente a carichi anche elevati.

Small Peanut e Small Peanut XS sono dedicate ai più piccoli in virtù dell'altezza minima dal terreno.

Abbandonarsi sulla palla, aiutando il movimento con il rotolamento e l'allungamento, permette ai bambini di sperimentare nuove sensazioni che portano ad una maggiore consapevolezza del corpo e delle sue capacità. Il diametro è studiato per accompagnare i movimenti, e accogliere il corpo perfettamente rilassato soprattutto nell'appoggio di braccia e gambe.

La qualità, la morbidezza e l'elasticità le rendono assolutamente sicure

Multi-purpose tools in double layer synthetic rubber that allow new exercises suitable for consolidation of motor patterns, to re-education and rehabilitation, to gymnastics. In rehabilitation they give security by offering better exercise stability. X-Ball in particular, with the central narrowing that makes it partly concave, can also be used for teaching the somersault and the handstand in total safety.

In fact, in the educational field, it allows exercises for two children (group work and socialization) or to one (astride) in absolute physical and psychological safety. Really useful also in physiotherapy treatment for warming up, stretching, toning. Re-inflatable and resistant to even high loads.

Small Peanut and Small Peanut XS are dedicated to children due to the minimum height from the ground.

Indulging on the ball, helping the movement with rolling and stretching, allows them to experience new sensations that lead to a greater awareness of their body and its capabilities. The diameter is designed to accompany their movements, and accommodate the relaxed body especially in resting the arms and legs.

Quality, softness and elasticity make them absolutely safe

Art. ULTbbs3
Pallone Jumbo Trial a 3 strati
Ø cm.28 - gr.280
Jumbo Trial Ball triple stratum
Ø 28 cm. - 280 gr.



Rimbalzo normale con diametro maggiorato per favorire l'apprendimento del bambino
Normal rebound with bigger diameter for youngest training and fun

pg.21



Le palle sensoriali rimbalzanti esaltano la tattilità e rappresentano anche uno strumento di automassaggio a pressione
To stimulate touch and also useful massage tools



Art. BTR1
Palla sensoriale Ø cm. 21 - gr. 420
Sensory Ball Ø 21 cm. - 420 gr.

Art. BTR2
Palla sensoriale Ø cm.12 - gr. 180
Sensory Ball Ø 12 cm. - 180 gr.

Allenando la visibilità laterale migliorano la percezione dello spazio, i movimenti e la sicurezza nella vita quotidiana
For space perception, coordination and everyday life safety



Art. TLV16
Palle morbide Trial per allenamento della visibilità laterale - set di 6 palle
Ø cm. 16 gr. 110
Soft balls for lateral visibility training - set of 6 balls
Ø 16 cm. 110 gr.

Art. TLV21
Set di 6 palle
Ø cm. 21 gr. 160
Soft balls for lateral visibility training - set of 6 balls
Ø 21 cm. 160 gr.

pg.8



Art. BS1T
PALLONE BASIC jelly touch
Ø 12/16 cm. gr.140 - colore verde
Basic Ball green color

Art. BS2T
PALLONE BASIC jelly touch
Ø 16/22 cm. gr.180 - colore arancio
Basic Ball orange color

Art. BS3T
PALLONE BASIC jelly touch
Ø 22/28 cm. gr.240 - colore rosso
Basic Ball red color

pg.21

BORSE - Bags

Art. STD02

Borsa Big
doppio fondo
cm. 53,5x45h.x32,5
poliestere 600
Soccer bag large

Art. STD09

Borsa Medium
doppio fondo
cm. 50x42h.x30
poliestere 600
Soccer bag medium

Art. STD03

Borsa Small
doppio fondo
cm. 47,5x40h.x26,5
poliestere 600
Soccer bag small



**QUANTITÀ PER MODELLO
E COLORE MULTIPLA DI 10 PEZZI**
Quantity by model and color
multiple of 10 pieces

COLORI DISPONIBILI
rosso, royal, navy
(no Small, no Medium),
nero, verde (no Big),
bordeaux
Colors: red, royal, black,
green (no Big), navy
(no Small, no Medium),
bordeaux



pg.23



**QUANTITÀ PER COLORE
MULTIPLA DI 15 PEZZI**
Quantity by color
multiple of 15 pieces

**QUANTITÀ PER COLORE
MULTIPLA DI 10 PEZZI**
Quantity by color
multiple of 10 pieces

Art. STD04

Borsa TOP bicolore in poliestere 600 con fondo rigido h. 15 cm. con tracolla e porta nome, tre tasche, dim. cm. 53,5x45h.x32,5 colori: navy/royal, nero/grigio, navy/rosso, nero/verde, nero/bordeaux
Soccer Bag bicolor in polyester 600 1 pocket size 53,5x45h.x32,5 cm.
colors: navy/royal, black/grey, navy/red, black/green, black/bordeaux



Art. STD18

Zainetto doppio fondo poliestere 600 2 tasche - cm. 34x47h.x24 fondo rigido colori: royal, nero, rosso, navy, bordeaux
Rucksack in 6 different colors



Art. STD20
Borsa Portamute cm. 65x34h.x27
poliestere 600 - colore nero
Soccer bag for uniforms
dim. 65x34h.x27 cm. - color black

pg.24

QUANTITÀ PER COLORE
MULTIPLA DI 10 PEZZI
Quantity by color
multiple of 10 pieces



Art. STD08
Borsa palestra poliestere 600 cm.60x30h.x32
con due tasche e vano portascarpe
colore royal
Gym Bag color royal



Art. ZBGL
BORSA/ZAINETTO monocolor economica
cm. 36x38 vari colori - serigrafabile su richiesta
Backpack one color with your logo on request

pg.23



Art. STD07
Borsa Medica dim. cm. 40x28,5h.x20
poliestere 600 - colore nero
Bag for First Aid 40x28,5h.x20 cm.

pg.24



Art. BMD
Borsa Medica dim. cm. 37x29h.x17
Bag for First Aid 37x29h.x17 cm.

CONTENITORI PORTAPALLONI - Baskets for balls



Art. FP400
Contentore portapalloni a soffietto in alluminio
cm. 60x60x100h pieghevole con sacca
Basket for balls in aluminium
60x60x100h cm. foldable with bag



Art. F401
Contentore portapalloni in ferro verniciato
cm. 80x55x60h pieghevole
Basket for balls in painted steel 80x55x60h cm. foldable



Art. F402
Contentore portapalloni
in ferro zincato
cm. 60x60x90h pieghevole
Basket for balls
in galvanized steel
60x60x90h cm. foldable

pg.23

Art. F404
Contentore portapalloni
in rete metallica verniciata
cm. 70x70x70h pieghevole
con lucchetto
Basket for balls
painted with metallic net
70x70x70h cm.
foldable, with lock



Art. F403G Contentore portapalloni
in ferro verniciato cm. 100x75x90h
pieghevole con lucchetto
Basket for balls in painted steel
100x75x90h cm. foldable, with lock



pg.23

Art. F403ZN
Contentore portapalloni
in ferro zincato cm. 100x75x90h
pieghevole con lucchetto
Basket for balls in galvanized steel
100x75x90h cm. foldable, with lock



PORTE CALCIO - Soccer Goals



Art. 109

Coppia Porte fisse regolamentari m. 7,32 x 2,44 in lega leggera costruite secondo lo standard europeo di qualità UNI EN 748 con paletti tendirete posteriori in acciaio zincato, pali sezione mm. 120x100 verniciati con smalto acrilico non tossico, ganci reggirete e bussole per interrimento pali incluse (ribaltine alzarete non incluse)

Pair of regular Goals in light alloy manufactured according to the UNI EN 748 European standard of quality norms. Pipe section 120x100 mm. painted with non toxic white. Net holders, rear posts and underground sockets included (liftable ground backframes not included)

pg.24

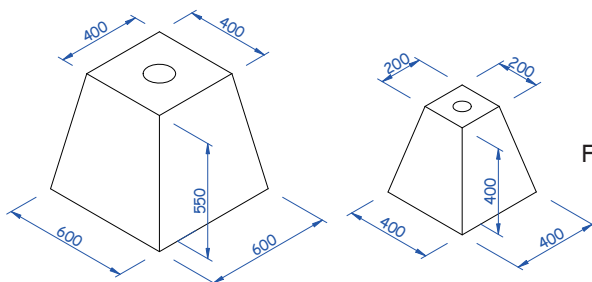

Ancoraggio tramite piloti in cemento (non inclusi)

Fixing with concrete blocks
(not included)

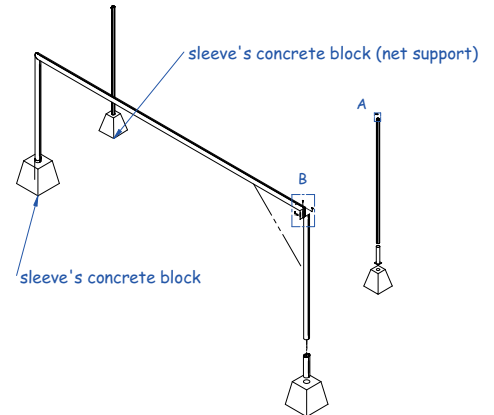

ATTENZIONE: in caso di ordine errato da parte del Cliente le porte, una volta consegnate, non possono essere rese

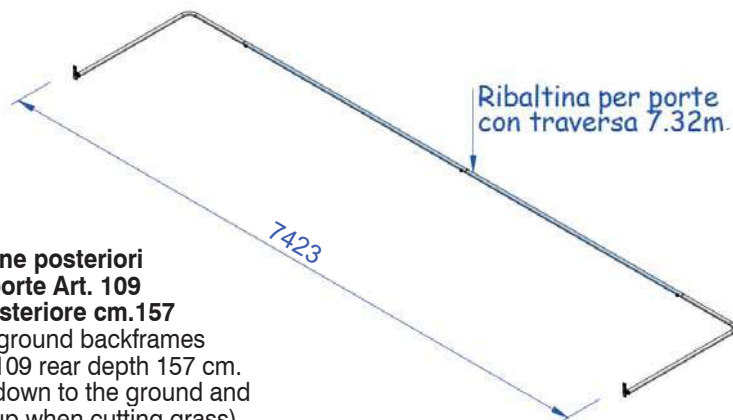

Art. 109.G

Coppia ribaltine posteriori alzarete per porte Art. 109 profondità posteriore cm.157

Pair of liftable ground backframes for Goals Art. 109 rear depth 157 cm. (to keep nets down to the ground and to raise them up when cutting grass)

Art. 109.G200

Coppia ribaltine posteriori alzarete per porte Art. 109 profondità posteriore cm.200

Pair of liftable ground backframes for Goals Art. 109 rear depth 200 cm. (to keep nets down to the ground and to raise them up when cutting grass)

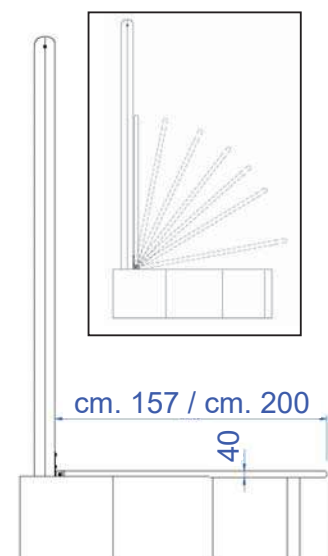



Art. 120-RG
Coppia ruote per porte trasportabili regolamentari Art. 110FG, 110-D e 110G
Pair of wheels for regular size transportable goals Art. 110FG, 110-D and 110G

Art. 110FG Coppia Porte trasportabili in lega leggera regolamentari m. 7,32 x 2,44 profilo sezione mm. 120x100 verniciate con smalto acrilico non tossico base di appoggio posteriore con tubo tondo in ferro - a norma UNI EN 748
Pair of transportable Goals in light alloy regular size, pipe section mm. 120x100 painted with non toxic white - back frame in round iron pipe - UNI EN 748 standard

pg.24



LE PORTE TRASPORTABILI IN FASE DI GIOCO DEVONO ESSERE ZAVORRATE SULLA BASE POSTERIORE O FISSATE A TERRA CON PICCHETTI PER MOTIVI DI SICUREZZA. LE RUOTE GOMMATE SONO OPTIONAL

Transportable goals must always be anchored to the ground by sacs of sand or metal pegs, for safety reasons. Wheels are optional

Art. 110-D Coppia Porte trasportabili regolamentari m. 7,32 x 2,44 in lega leggera profilo sezione mm. 120x100 - verniciate con smalto acrilico non tossico base di appoggio posteriore con profilo ovale in alluminio mm. 65x55 - a norma UNI EN 748
Pair of transportable Goals in light alloy regular size, pipe mm. 120x100 painted with non toxic white - back frame in aluminium ovoidal pipe 65x55 mm.



Art. AMCP

Carrello per il trasporto di porte (trasportabili) regolamentari e ridotte - brevettato
Patented trolley for moving official and junior size transportable goals

pg.26



Da abbinare preferibilmente a reti con profondità cm. 100x200
To be combined preferably with nets with depth 100x200 cm.

Art. 110G Coppia Porte trasportabili in lega leggera regolamentari m. 7,32 x 2,44 profilo mm. 120x100 verniciate con smalto acrilico non tossico, base di appoggio posteriore con profilo in lega mm. 120x100 - a norma UNI EN 748 e FIGC
Pair of transportable Goals in light alloy regular size, pipe mm. 120x100, painted with non toxic white - back frame pipe 120x100 mm. - UNI EN 748 and FIGC standard



Art. 110GMR Set 4 ruote per porte trasportabili regolamentari Art. 110G (2 set per 1 coppia di porte).

pg.24

Ciascuna ruota in dotazione ha una posizione di riposo e una posizione di trasporto (per passare dall'una all'altra occorre far ruotare il dispositivo intorno al perno). Dunque, le ruote restano sempre fissate al telaio posteriore della porta

Set of 4 wheels for regular size transportable goals Art. 110G (2 set for 1 pair of goals). Each wheel remains fixed to the back ground frame also when goals are in use, in stand by position. To switch the wheel into transport position you have to turn it around the pivot

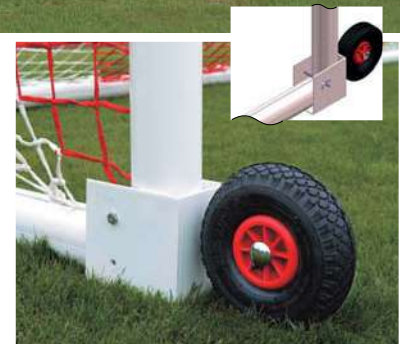

Art. 120-RG
Coppia ruote per porte trasportabili regolamentari Art. 110FG, 110-D e 110G
Pair of wheels for regular size transportable goals Art. 110FG, 110-D and 110G

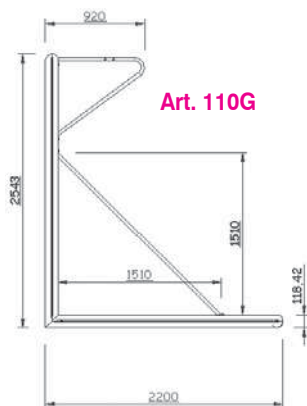

Art. 110G

Art. 4580M
Mollone per ancoraggio porte trasportabili regolamentari e ridotte su terreno naturale
Spring for goal anchoring on natural grass

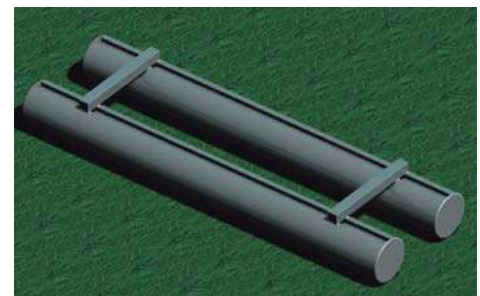

Art. AFC
Zavorra in alluminio per ancoraggio porte trasportabili regolamentari e ridotte
Aluminium weighted pipes for goal anchoring

ATTENZIONE: in caso di ordine errato da parte del Cliente le porte, una volta consegnate, non possono essere rese

Art. DSSCE
Sacco zavorra vuoto (da riempire con sabbia) per ancoraggio porte trasportabili regolamentari e ridotte
Empty Ballast Bag (to be filled with sand) for goal anchoring

pg.26



Art. DSS20
Sacco zavorra kg. 20 (riempito con sabbia) per ancoraggio porte trasportabili regolamentari e ridotte
Ballast Bag weight 20 Kg. for goal anchoring

Porte fisse (con bussole e pali da interrare) e trasportabili in lega leggera o acciaio, sezione tubo mm. 120x100 o mm.80 - dimensioni m. 3x2 - m. 4x2 - m. 5x2 - m. 6x2
 Fixed and transportable Goals in light alloy or painted steel, pipe section 120x100 mm. or 80 mm. dimensions m. 3 x 2 - m. 4 x 2 - m. 5 x 2 - m. 6 x 2

pg.25



Art. 114-T
 Art. 118-G
 Art. 116-TDV
 Art. 120-TG

Base posteriore in tubo tondo
 Round pipe ground base

ATTENZIONE: in caso di ordine errato da parte del Cliente le porte, una volta consegnate, non possono essere rese

Art. 114-T

Coppia Porte m. 4 x 2 a traversa intera in acciaio trasportabili tubo sezione 80 mm.
 Pair of Goals m. 4 x 2 - 1 piece crossbar in painted steel, transportable, pipe 80 mm.

Art. 118-G

Coppia Porte m. 4 x 2 a traversa intera in lega di alluminio trasportabili tubo sezione 80 mm.
 Pair of Goals m. 4 x 2 - 1 piece crossbar in light alloy, transportable, pipe 80 mm.

Art. 116-TDV

Coppia Porte m. 5 x 2 a traversa divisa in lega di alluminio trasportabili tubo 80 mm.
 Pair of Goals m. 5 x 2 - crossbar in 2 pieces in light alloy, transportable, pipe 80 mm.

Art. 120-TG

Coppia Porte m. 6 x 2 a traversa divisa in lega di alluminio trasportabili tubo sezione 80 mm.
 Pair of Goals m. 6 x 2 - crossbars in 2 pieces in light alloy, transportable, pipe 80 mm.

Art. 118A
Coppia Porte m. 4 x 2 a traversa divisa in lega di alluminio trasportabili tubo 80 mm. con base posteriore a sezione quadra
 Pair of Goals m. 4 x 2 - crossbars in 2 pieces in light alloy, transportable, pipe 80 mm. with square pipe ground bases

Art. 1129A
Coppia Porte m. 5 x 2 a traversa divisa in lega di alluminio trasportabili tubo 80 mm. con base posteriore a sezione quadra
 Pair of Goals m. 5 x 2 - crossbars in 2 pieces in light alloy, transportable, pipe 80 mm. with square pipe ground bases

Art. 1121A
Coppia Porte m. 6 x 2 a traversa divisa in lega di alluminio trasportabili tubo 80 mm. con base posteriore a sezione quadra
 Pair of Goals m. 6 x 2 - crossbars in 2 pieces in light alloy, transportable, pipe 80 mm. with square pipe ground bases



Art. 118A
 Art. 1129A
 Art. 1121A

Da abbinare esclusivamente a reti con profondità cm. 100x160
 To be combined only with nets with depth 100x160 cm.

Base posteriore a sezione quadra
 Reinforced ground base

LE PORTE TRASPORTABILI IN FASE DI GIOCO DEVONO ESSERE ZAVORRATE SULLA BASE POSTERIORE O FISSATE A TERRA CON PICCHETTI PER MOTIVI DI SICUREZZA. LE RUOTE GOMMATE SONO OPTIONAL
 Transportable goals must always be anchored to the ground by sacs of sand or metal pegs, for safety reasons. Wheels are optional



Art. 120-R
Coppia ruote per porte trasportabili ridotte Art. 118A, 1129A, 1121A
 Pair of wheels for reduced size transportable goals Art. 118A, 1129A, 1121A

pg.26



Art. 4640
Coppia ruote per porte trasportabili ridotte Art. 114-T, 118-G, 116-TDV, 120-TG
 Pair of wheels for reduced size transportable goals Art. 114-T, 118-G, 116-TDV, 120-TG



Le porte ridotte sono disponibili anche nel modello fisso con bussole e pali da interrare
 Available also fixed models with underground sockets



Art. 119G
Art. 120-G

Da abbinare esclusivamente a reti con
profondità cm. 100x160
To be combined only with nets with
depth 100x160 cm.

Art. 119G Coppia Porte m. 5 x 2 a traversa divisa
in acciaio trasportabili tubo 80 mm.
Pair of Goals m. 5x2 crossbar in 2 pieces in painted steel,
transportable, pipe 80 mm.

Art. 120-G Coppia Porte m. 6 x 2 a traversa divisa
in acciaio trasportabili tubo sezione 80 mm.
Pair of Goals m. 6 x 2 crossbars in 2 pieces
in painted steel, transportable, pipe 80 mm.



pg.25

Art. 241C Chiave per kit
di fissaggio Art. 240AF
Key for ground anchoring
kit Art. 240AF



Art. 240RU Coppia ruote
gommate con staffa per porte
Art. 119G/120-G
Pair of wheels for transportable
goals Art. 119G/120-G

Art. 240AF Kit di fissaggio a
terra per porte Art. 119G/120-G
Ground anchoring kit for
transportable goals
Art. 119G/120-G

ATTENZIONE:
in caso di ordine errato da parte del Cliente
le porte, una volta consegnate,
non possono essere rese



Art. 122G
Art. 121G

pg.26

Art. 122G
Coppia Porte Calcetto m. 3 x 2 trasportabili
in acciaio verniciato tubo sezione 80 mm.
Pair of Goals m.3x2 transportable in painted steel pipe 80 mm.

Art. 121G
Coppia Porte Calcetto m. 3 x 2 trasportabili
in lega leggera tubo sezione 80 mm.
Pair of Goals m.3x2 transportable in light alloy pipe 80 mm.

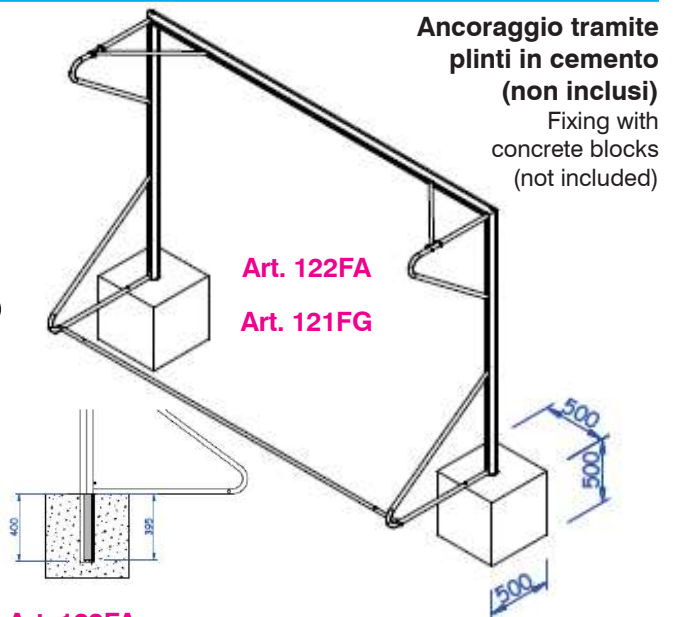

**Ancoraggio tramite
plinti in cemento
(non inclusi)**
Fixing with
concrete blocks
(not included)

Art. 122FA
Art. 121FG

Art. 122FA
Coppia Porte Calcetto m. 3 x 2 fisse con bussole da
interrare in acciaio verniciato tubo 80 mm.
Pair of Goals m.3x2 fixed in painted steel pipe 80 mm.

Art. 121FG
Coppia Porte Calcetto m. 3 x 2 fisse con bussole da
interrare in lega leggera tubo 80 mm.
Pair of Goals m.3x2 fixed in light alloy pipe 80 mm.

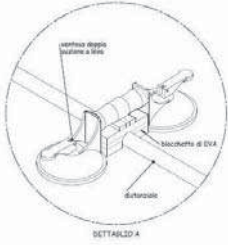

Art. VTCL

Ventosa doppia per ancoraggio a terra porte calcetto su superfici indoor lisce (si consigliano 2 kit per ciascuna porta)
Ground anchoring suckers for reduced goals to be used upon indoor smooth floors (it takes 2 kits for every goal)

pg.26



Art. PC04

Picchetto in acciaio per ancoraggio di porte ridotte con distanziale sottile su terreno naturale
Steel anchoring hook for reduced soccer goals with thin pipe ground bases

Art. DSSCE

Sacco zavorra vuoto (da riempire con sabbia) per ancoraggio porte trasportabili regolamentari e ridotte
Empty Ballast Bag (to be filled with sand) for goal anchoring



Art. DSS20

Sacco zavorra kg. 20 (riempito con sabbia) per ancoraggio porte trasportabili regolamentari e ridotte
Ballast Bag weight 20 Kg. for goal anchoring

Art. AM01.7/.../AM01.3

TUBO ZAVORRA in PVC diametro 50 mm. atossico, flessibile, modellabile, appesantito da composto ecologico (peso 6 Kg. per metro) resistente alle alte e basse temperature e ai raggi ultravioletti per porte ridotte mt. 3x2/4x2/5x2/6x2 e regolamentari sia fisse che trasportabili

pg.26

Weighted soft pipe 50 mm. diameter (6 Kg. per meter) resistant to high/low temperatures and ultra violet rays for safe anchoring of transportable goals m. 3x2/4x2/5x2/6x2 and official size goals to the ground



Art. 353.G10

Serie 100 ganci reggirete di ricambio modello a rotazione
100 spare Net Holders rotating model



Art. 353.G13



Art. AS8060

Serie 100 ganci reggirete di ricambio da fissare con viti
100 spare Net Holders with screws



pg.26

Art. 353 Serie 100 ganci reggirete di ricambio da fissare con viti
100 spare Net Holders with screws



Art. V590010

Serie 100 ganci reggirete di ricambio
100 spare Net Holders



Art. V680011 Serie 100 ganci reggirete di ricambio a base rotonda da fissare con viti
100 spare Net Holders

ATTENZIONE: verificate la tipologia dei ganci delle Vostre porte prima di ordinare i ricambi
Please check the model of your holders before ordering spares



Art. GFG

Gancio reggirete di ricambio in ferro con piastrina
Spare iron Net Holder



Art. SC1051

Serie 100 ganci reggirete di ricambio
100 spare Net Holders



Art. 110BAG

Serie 60 ganci reggirete di ricambio
60 spare Net Holders

pg.26

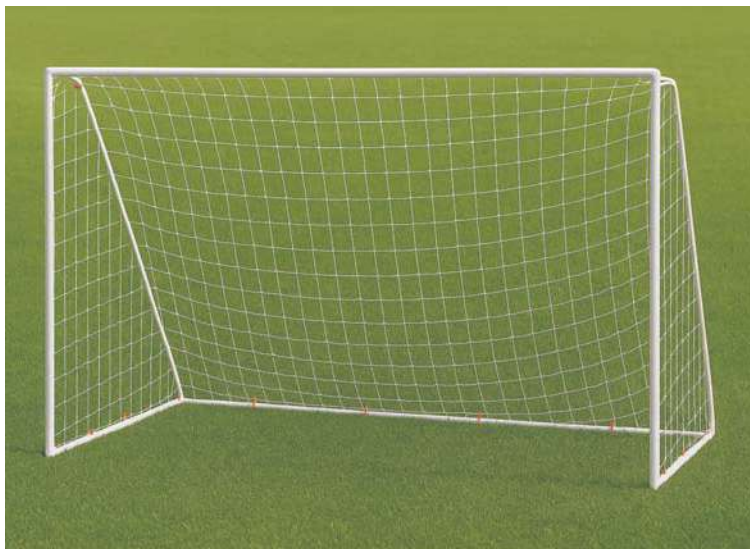

Ideale per uso
privato
Not for official
matches

Art. SG176

**Porta m. 3x2 trasportabile
in ferro verniciato,
tubo sezione mm. 32
completa di rete, ganci e
picchetti**

3x2 meter transportable
Goal in painted iron, pipe
section 32 mm. complete
with net and anchor pegs



pg.26

Ideale per uso
privato
Not for official
matches

Art. 500SG

**Porta m. 3x2 trasportabile
in ferro verniciato,
tubo sezione mm. 50
completa di rete, ganci e
picchetti**

3x2 meter transportable
Goal in painted iron, pipe
section 50 mm. complete
with net and anchor pegs

**ATTENZIONE: in caso di ordine errato da parte del Cliente
le porte, una volta consegnate, non possono essere rese**

pg.26

PORTE BIFRONTALI in lega leggera dimensioni m. 3x2 - 4x2 - 6x2

Available 2 SIDE GOALS in light alloy dimensions m. 3 x 2 - 4 x 2 - 6 x 2



Art. 084.8

**Porta bifrontale
m. 4 x 2
in lega leggera
sezione tubo 80 mm.
completa di rete**

Two Side Goal
4 x 2 m. in light alloy
pipe 80 mm.
net included

Art. 083

**Porta bifrontale
m. 6 x 2
in lega leggera
sezione tubo 80 mm.
completa di rete**

Two Side Goal
6 x 2 m. in light alloy
pipe 80 mm.
net included



Art. ML1208

PORTE MINICALCIO m. 1,2 x 0,8 in alluminio tubo sezione mm.80, complete di reti
Pair of aluminium mini football goals 1,2 x 0,8 m. nets and pegs included

pg.27



Art. ML151

PORTE MINICALCIO m. 1,5 x 1 in alluminio tubo sezione mm.80, complete di reti
Pair of aluminium mini football goals 1,5 x 1 m. nets and pegs included

pg.27



Art. ML1812

PORTE MINICALCIO m. 1,8 x 1,2 in alluminio tubo sezione mm.80, complete di reti
Pair of aluminium mini football goals 1,8 x 1,2 m. nets and pegs included

MINIPORTE Mini-goals



Art. 123C

Coppia porte minicalcio in acciaio verniciato m. 1,5 x 1 complete di reti e picchetti

Pair of mini football goals 1,5 x 1 m. in painted steel pegs and nets included

pg.27



Art. 123F

Coppia porte minicalcio in acciaio verniciato m. 1,5 x 1 complete di reti e picchetti

Pair of mini football goals 1,5 x 1 m. in painted steel pegs and nets included

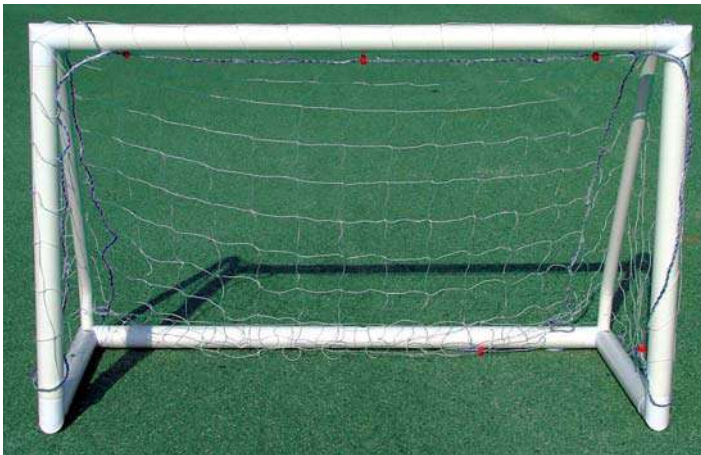

Art. 124C

Coppia porte minicalcio m. 1,5 x 1,1 in PVC rinforzato tubo Ø mm. 70 complete di reti e picchetti

Pair of PVC mini football goals 1,5 x 1,1 m. pipe Ø 70 mm. pegs and nets included

pg.27

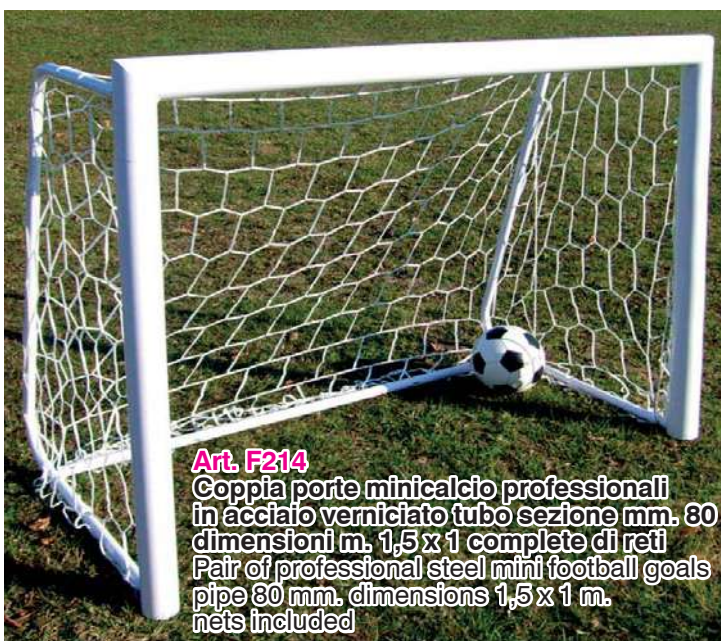

Art. F214

Coppia porte minicalcio professionali in acciaio verniciato tubo sezione mm. 80 dimensioni m. 1,5 x 1 complete di reti
Pair of professional steel mini football goals pipe 80 mm. dimensions 1,5 x 1 m. nets included



pg.27

Art. F218

Coppia porte minicalcio professionali in acciaio verniciato tubo sezione mm. 80 dimensioni cm. 90x60 complete di reti

Pair of professional steel mini football goals pipe 80 mm. dimensions 90x60 cm. nets included

ATTENZIONE: in caso di ordine errato da parte del Cliente le porte, una volta consegnate, non possono essere rese



Art. 124
Coppia porte minicalcio in polipropilene
m. 1,5 x 1,1 tubo Ø mm. 40 complete di reti
Pair of polypropylene mini football goals 1,5 x 1,1 m.
pipe Ø 40 mm. - nets included



Dimensioni porta ribaltata m. 1,5 x 0,80
Goal upside down dimensions 1,5 x 0,80 m.



Art. A124
Coppia porte minicalcio in alluminio m. 1,5 x 1,1
tubo Ø mm. 32 complete di reti
Pair of aluminium mini football goals 1,5 x 1,1 m.
pipe Ø 32 mm. - nets included



Dimensioni porta ribaltata m. 1,5 x 0,80
Goal upside down dimensions 1,5 x 0,80 m.

pg.27



Art. PUG
Coppia porte minicalcio in nylon
m. 1,83 x 1,07
complete di reti,
picchetti e borsa
Pair of nylon mini football goals
1,83 x 1,07 m.
nets, pegs and bag included

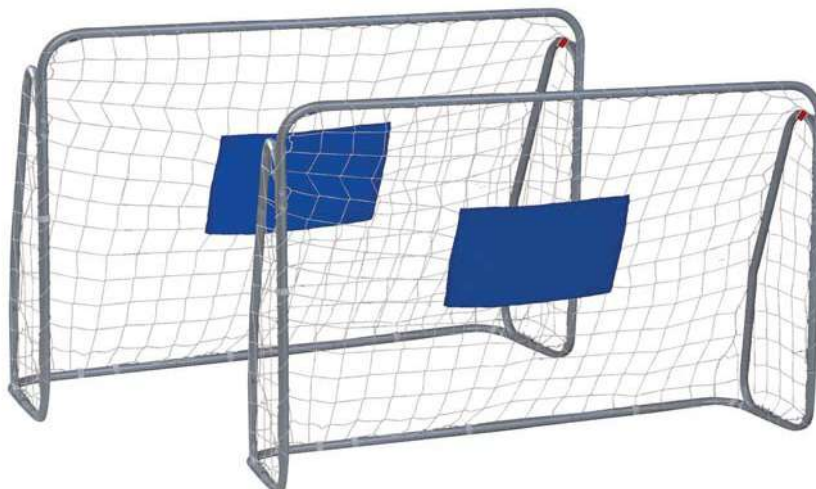

Art. POR-14
Coppia porte minicalcio
m. 2,15 x 1,52 in acciaio verniciato
complete di reti
Pair of steel mini football goals
2,15 x 1,52 m. - nets included

PORTA MINICALCIO CM.150x90 PIEGHEVOLE - Foldable 150x90 cm. mini football goal



pg.27

Art. BG150

Questa porta minicalcio pieghevole consente ad allenatori e giocatori di concentrarsi sugli esercizi fondamentali poiché per il montaggio sono richiesti solo 10 secondi. Il telaio facilmente trasportabile è durevole, sicuro e realizzato con una struttura in PVC resistente al calore. Esso è dotato di bobine progettate per tornare in posizione dopo una pallonata e, soprattutto, la porta rimane stabile senza necessità di ancoraggio a terra grazie al sistema a molla integrato.

A differenza di molte porte da calcio in metallo comunemente usate, questa porta minicalcio in PVC è totalmente sicura e previene il rischio di infortuni qualora un giocatore andasse a sbatterci contro.

La porta minicalcio pieghevole può essere utilizzata sulle diverse tipologie di superfici (erba, sabbia, cemento, legno). Non ha bisogno di borsa dato che la sua resistente rete funge anche da rivestimento. La porta minicalcio da 150 cm x 90 cm si riduce ad una dimensione compatta di 180 cm x 15 cm x 10 cm, e le comode cinghie rendono il trasporto agevole visto che il peso è di soli 7 chilogrammi.

Le porte minicalcio pieghevoli vengono utilizzate quotidianamente presso alcune delle più rinomate accademie e scuole calcio di club professionistici tra cui Chelsea, Barcellona, Ajax, Arsenal, Manchester United, Liverpool ed Everton. Sono approvate e raccomandate dalla Federcalcio catalana in Spagna, dalla Federazione norvegese, nonché dall'Oregon Youth Soccer Association.



SI INSTALLA
IN 10 SECONDI
READY IN 10
SECONDS

LEGGERA E
COMODA PER
IL TRASPORTO
LIGHT AND
COMFORTABLE
FOR TRANSPORT



This foldable mini football goal allows coaches and players to focus on core exercises as only 10 seconds are required for assembly. The easily transportable frame is durable, safe and made with a heat resistant PVC construction. It's equipped with coils designed to return to position after a ball hit and, above all, the goal remains stable with no need to be anchored to the ground thanks to the integrated spring system.

Unlike many commonly used metal soccer goals, this PVC mini football goal is totally safe and prevents the risk of injury should a player bump into it.

The foldable mini football goal can be used on different surfaces (grass, sand, concrete, wood). It does not need a bag as its durable net also acts as a covering. The 150 cm x 90 cm mini football goal is reduced to a compact size of 180 cm x 15 cm x 10 cm, and the comfortable straps make transport easy as the weight is only 7 kilograms.

Foldable mini football goals are used daily at some of the most renowned academies and soccer schools of professional clubs including Chelsea, Barcelona, Ajax, Arsenal, Manchester United, Liverpool and Everton. They are approved and recommended by the Catalan Football Association in Spain, the Norwegian Federation, as well as the Oregon Youth Soccer Association.

RETI REGOLAMENTARI COLORE BIANCO - White color official size Nets

Le reti a maglia esagonale sono tessute, quelle a maglia quadrata sono annodate (eccetto Art. B011) Square mesh nets are knotted (except Art. B011)

Profondità: la prima grandezza indica la sporgenza posteriore della rete ad altezza traversa, la seconda grandezza indica la sporgenza posteriore a terra
 Depth: the first figure indicates the rear depth of the net at crossbar level, the second figure indicates the rear depth at ground



Art. B011
 polipropilene h.t. mm.6
 maglia mm.100 mesh
 colore bianco
 white
 certificate FIGC/LND
 certified
 profondità
 cm.200x200 depth

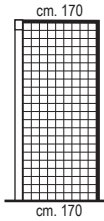
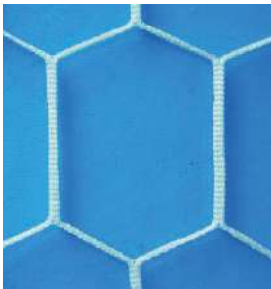
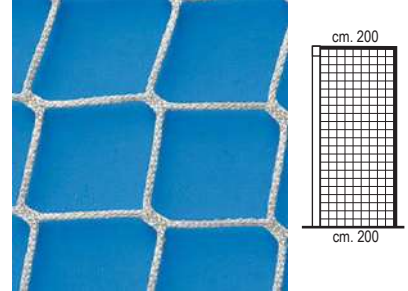

Art. 125
 polipropilene h.t. mm. 4
 profondità
 cm.170x170 depth

pg.27 pg.28

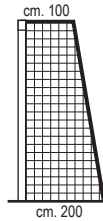
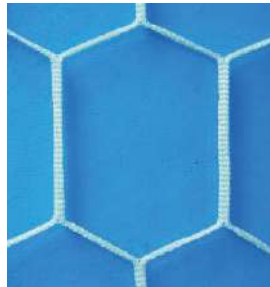

Art. 126
 polipropilene h.t. mm. 5
 profondità
 cm.100x200 depth

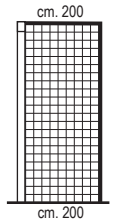
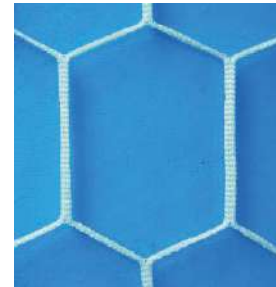

Art. 127
 polipropilene h.t. mm. 5
 profondità
 cm.200x200 depth

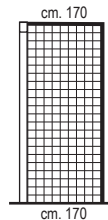
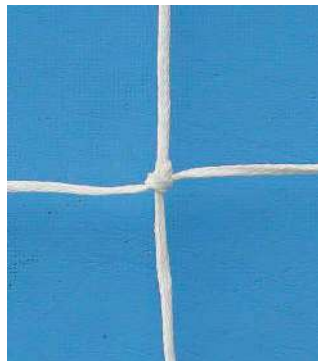

Art. B003
 polietilene
 mm. 2,5
 profondità
 cm.170x170
 depth

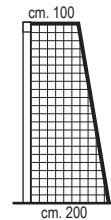
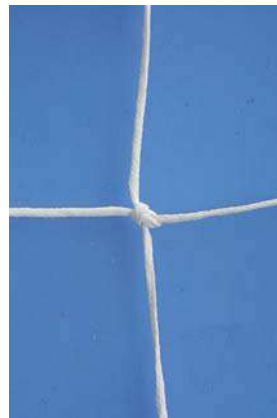

Art. B19
 polietilene
 mm. 3,5
 profondità
 cm.100x200
 depth

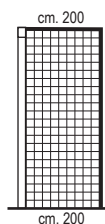
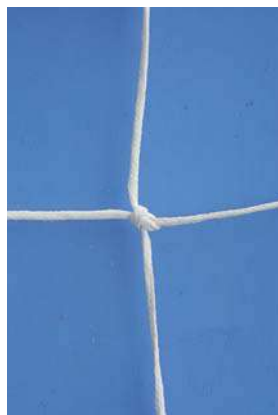

Art. 128E
 polietilene
 mm. 3,5
 profondità
 cm.200x200
 depth

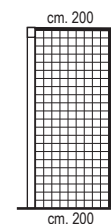
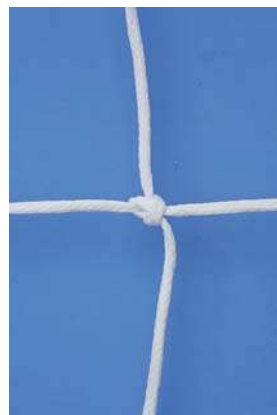

Art. 128
 polietilene
 mm. 4,5
 profondità
 cm.200x200
 depth



Art. 128FR

RETI REGOLAMENTARI COLORATE
Striped official size Nets

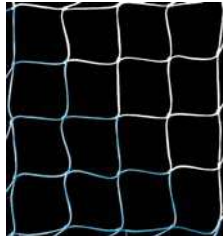
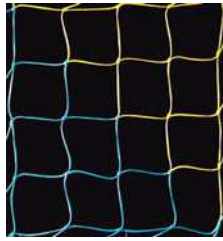

Art. 128FR Coppia reti annodate in polietilene mm.4 bianche o a strisce colorate (bianco/royal, bianco/rosso, giallo/royal) profondità cm.100x250 depth
Pair of nets polyethylene 4 mm. color stripes, knotted (available in white, white/royal, yellow/royal, white/red)

pg.28

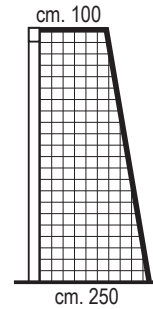

Art. 128C Coppia reti annodate in polietilene mm. 3,5 a strisce colorate (bianco-royal, bianco/rosso, giallo/royal, rosso/royal, bianco/nero, bianco/verde) profondità cm. 200x200 depth
Pair of nets polyethylene 3,5 mm. color stripes, knotted (available in white/royal, yellow/royal, white/red, white/black, white/green, red/royal)

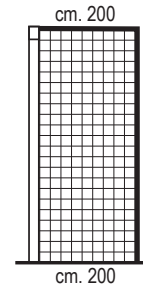

Art. 129T

Coppia reti polipropilene h.t. mm. 4 annodate a mano a strisce colorate (bianco/viola, rosso/nero, giallo/rosso, giallo/verde, giallo/nero, arancio, rosso/verde, bianco/rosso, bianco/royal, bianco/nero, bianco/verde, rosso/royal, giallo/royal, tricolore Italia Tim Cup) profondità cm. 200x200 depth
Pair of nets with color stripes, hand knotted in various combinations



Art. 129T.SP

Coppia reti polipropilene h.t. mm. 4 annodate a mano a strisce colorate (qualsiasi combinazione di colori a richiesta) profondità cm. 200x200 depth
Pair of nets with color stripes, hand knotted any combination

RETI RIDOTTE COLORE BIANCO - White Color Reduced size Nets - m.6x2,2/m.6,5x2,5

Art. 131.22
Coppia Reti
m. 6x2,2
annodate in polietilene mm. 3,5 profondità cm.100x160

Pair of knotted nets 6x2,20 m. polyethylene thickness 3,5 mm. 100x160 cm. depth

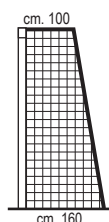

pg.28

Art. 131.5
Coppia Reti
m. 6,50x2,50
in polipropilene h.t. mm. 4 profondità cm.120x120
Pair of nets 6,50x2,50 m. polypropylene thickness 4 mm. 120x120 cm. depth

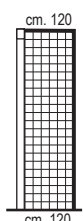
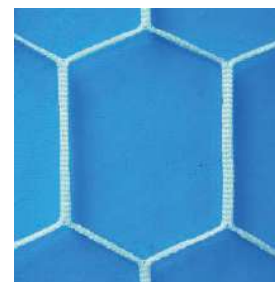

RETI RIDOTTE COLORE BIANCO - White Color Reduced size Nets - m.6x2/m.5x2/m.4x2

Profondità: la prima grandezza indica la sporgenza posteriore della rete ad altezza traversa, la seconda grandezza indica la sporgenza posteriore a terra
Depth: the first figure indicates the rear depth of the net at crossbar level, the second figure indicates the rear depth at ground

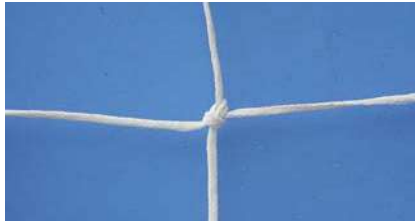

Art. 131N m. 6x2 / Art. 132N m. 5x2
Coppia Reti annodate in polietilene mm. 2,5 profondità cm.120x120
 Pair of knotted nets 6x2 m. / 5x2 m. polyethylene thickness 2,5 mm. 120x120 cm. depth

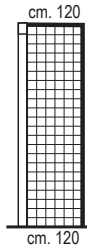

pg.28

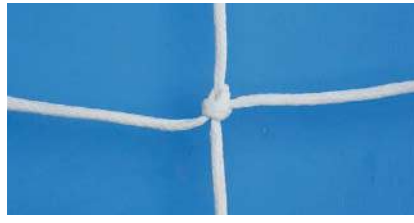

Art. B170 m. 6x2 / Art. B171 m. 5x2
Coppia Reti annodate in polietilene mm. 3,5 profondità cm.100x160
 Pair of knotted nets 6x2 m. / 5x2 m. polyethylene thickness 3,5 mm. 100x160 cm. depth

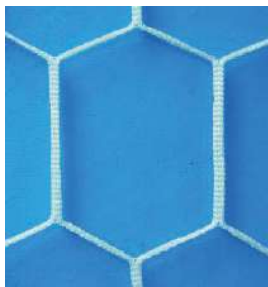
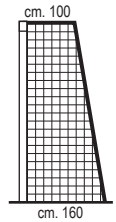

Art. 133
Coppia Reti m. 4x2 in polipropilene h.t. mm. 4 profondità cm. 120x120
 Pair of nets 4x2 m. polypropylene thickness 4 mm. 120x120 cm. depth

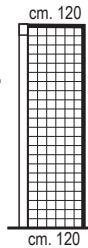

pg.28



Art. 133SN
Coppia Reti m. 4x2 annodate in polietilene mm. 2,5 profondità cm. 100x100
 Pair of knotted nets 4x2 m. polyethylene thickness 2,5 mm. 100x100 cm. depth

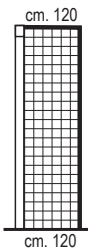
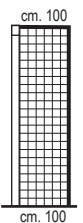

Art. 133LR
Coppia Reti m. 4x2 annodate in polietilene spessore mm. 3,5 profondità cm.120x120
 Pair of knotted nets 4x2 m. polyethylene thickness 3,5 mm. 120x120 cm. depth

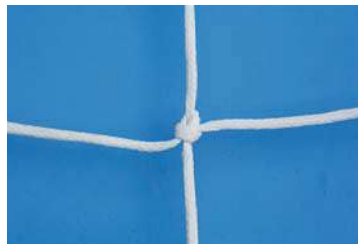

Art. 133NP
Coppia Reti m. 4x2 annodate in polietilene spessore mm. 3,5 profondità cm.100x160
 Pair of knotted nets 4x2 m. polyethylene thickness 3,5 mm. 100x160 cm. depth

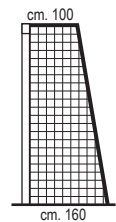

RETI RIDOTTE COLORATE - Striped reduced size Nets - m.6x2/m.5x2/m.4x2

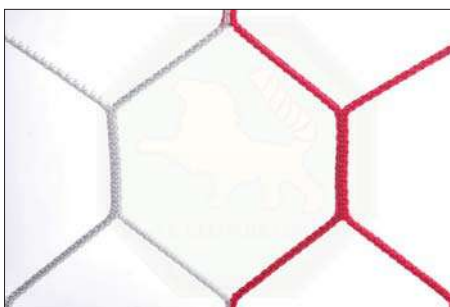

Art. 62BR m.6x2 profondità cm.100x160 depth
Art. 52BR m.5x2 profondità cm.100x160 depth
Art. 42BR m.4x2 profondità cm.120x120 depth
Coppia Reti a maglia esagonale in polipropilene ø mm. 4 colorate a strisce bianco/rosse
 Pair of white/red nets polypropylene thickness 4 mm. hexagonal mesh

pg.28

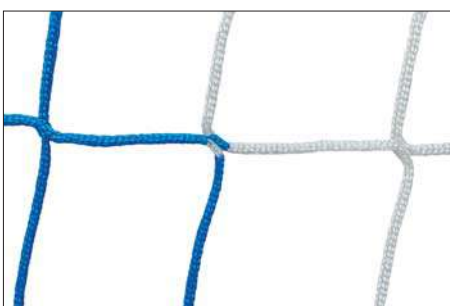
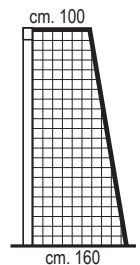

Art. 62BA m.6x2 profondità cm.100x160 depth
Art. 52BA m.5x2 profondità cm.100x160 depth
Art. 42BA m.4x2 profondità cm.120x120 depth
Coppia Reti a maglia quadrata in polipropilene ø mm. 4 colorate a strisce bianco/azzurre
 Pair of white/royal nets polypropylene thickness 4 mm. square mesh

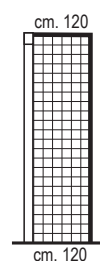

RETI CALCETTO - Futsal Nets m. 3x2

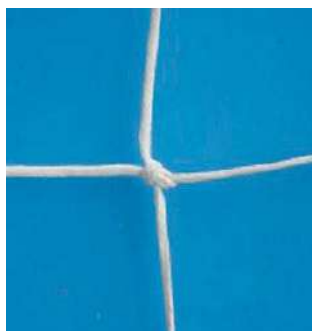

Art. 134E
Coppia reti m.3x2 annodate in polietilene spessore mm.2,5
 Pair of 3x2 m. nets knotted polyethylene thickness 2,5 mm.

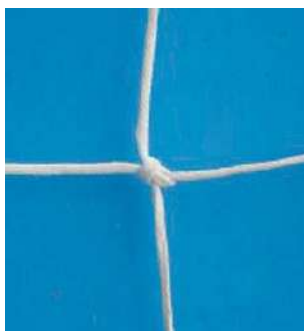

Art. 135C
Coppia reti m.3x2 annodate in polietilene spessore mm.3,5
 Pair of 3x2 m. nets knotted polyethylene thickness 3,5 mm.

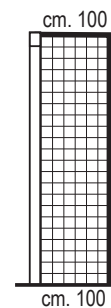

pg.29

Profondità cm.100x100
 Depth: 100x100 cm.

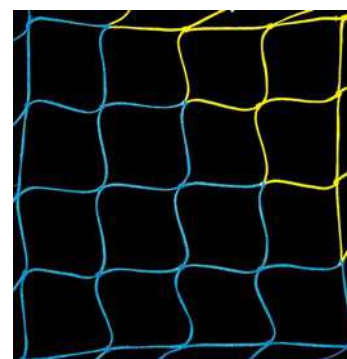
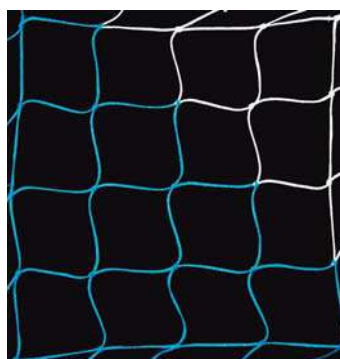

Art. 135FR Coppia reti m.3x2 annodate in polietilene spessore mm.3 colori: bianco/royal, bianco/rosso, giallo/royal
 Pair of 3x2 m. nets knotted polyethylene thickness 3 mm. colors: white/royal, white/red, yellow/royal

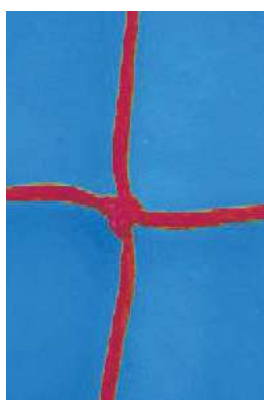
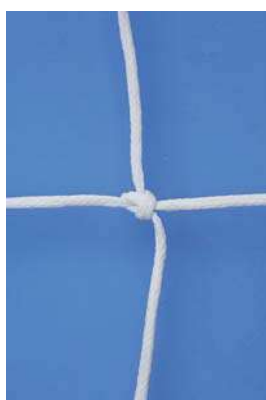

pg.29

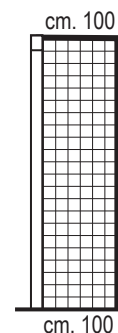
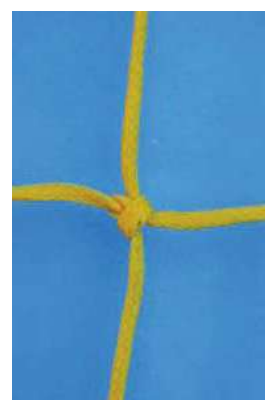

Art. 135 Coppia reti m.3x2 annodate in polietilene spessore mm.4,5 colore: bianco, rosso, giallo
 Pair of 3x2 m. nets knotted polyethylene thickness 4,5 mm. color: white, red, yellow



pg.29

Art. 137
Coppia reti m.1,5x1,1 per porte minicalcio polipropilene h.t.
 Pair of nets 1,5x1,1 m. for mini football goals

RETI PER CALCI DI PRECISIONE - Precision shooting nets

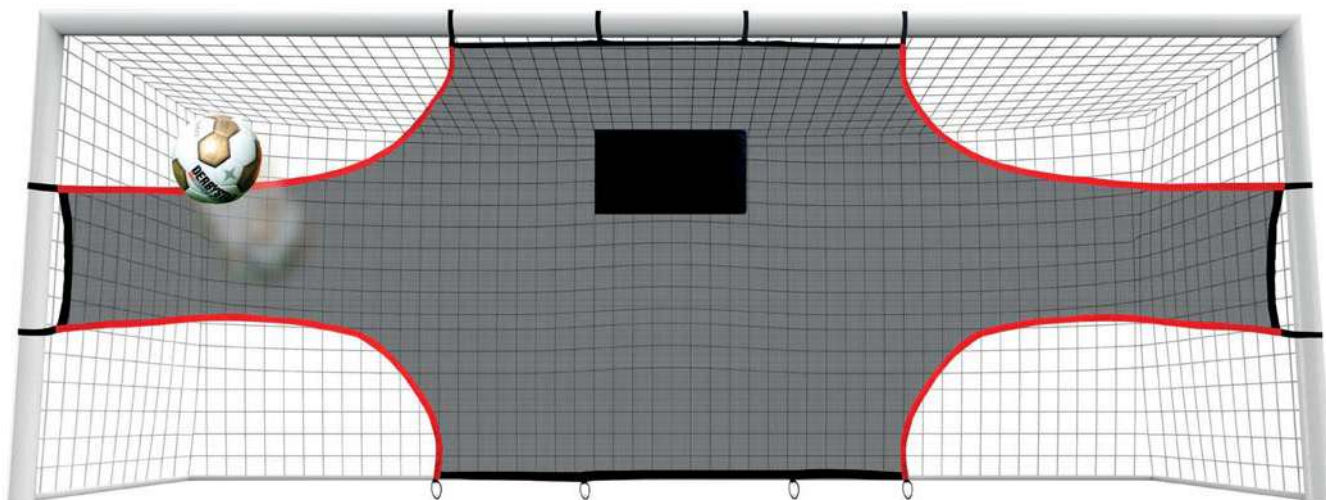

Art. PTI.732

Rete per calci di precisione per porta regolamentare completa di fasce con velcro per fissaggio a pali e traversa e picchetti per ancoraggio a terra
Precision shooting net for regular size goal complete with velcro straps for fixing to poles and crossbar and pegs for ground anchoring

pg.29

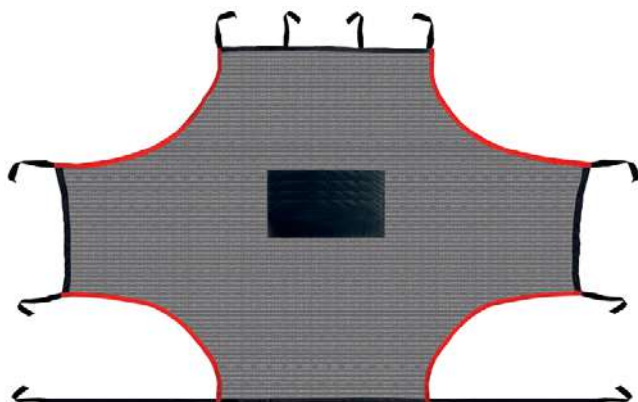

Art. PTI.275

Rete per calci di precisione per porta m.3x2 completa di fasce con velcro per fissaggio a pali e traversa e picchetti per ancoraggio a terra
Precision shooting net for 3x2 m. goal complete with velcro straps for fixing to poles and crossbar and pegs for ground anchoring

pg.29

Art. PTI.520

Rete per calci di precisione per porta m.5x2 completa di fasce con velcro per fissaggio a pali e traversa e picchetti per ancoraggio a terra
Precision shooting net for 5x2 m. goal complete with velcro straps for fixing to poles and crossbar and pegs for ground anchoring

pg.29

4 tasche bersaglio per calci di estrema precisione



4 target pockets for very accurate shootings

Basta raccogliere palloni in fondo al sacco, lascia che sia la palla a tornare da te!

Stop picking up balls all the time, let the ball come back to you!

Art. GM

Rete per calci di precisione con 4 tasche per porta regolamentare completa di corda elastica e picchetti
Precision shooting net with 4 accuracy pockets including elastic rope and pegs for regular size goal

Art. GM42

Rete per calci di precisione con 4 tasche per porta m. 4x2 completa di corda elastica e picchetti
Precision shooting net with 4 accuracy pockets including elastic rope and pegs for 4x2 m. goal

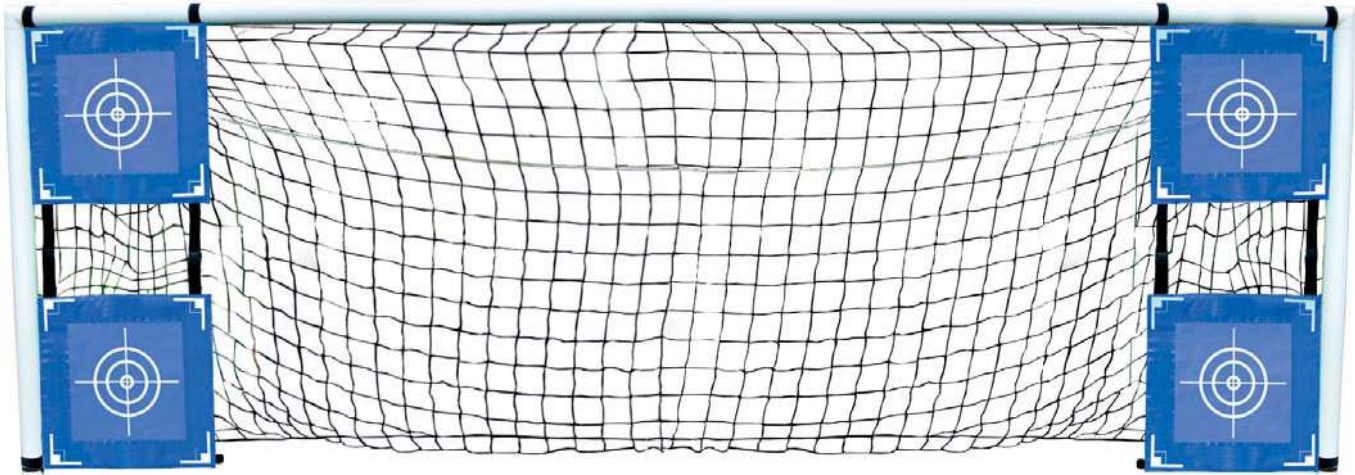

pg.29

Art. SF4106

Set di 4 bersagli per calci di precisione applicabili a porte di qualsiasi dimensione

Set of 4 targets for precision shooting applicable to soccer goals of any size

Particolare di un bersaglio
Detail of a target

pg.7

Art. QBFG

CROSS TRAINING

**rete bersaglio sempre in piedi
per allenamento alla precisione del cross,
del lancio in profondità,
del rinvio del portiere**

CROSS TRAINING

movable target to improve crossing,
long passing and GK kicks precision

**Il bersaglio ha dimensioni cm.120x120,
ha una inclinazione regolabile da
orizzontale a quasi verticale ed è in grado
di ricevere la palla ad altezze comprese
tra cm.175 e cm.262
senza mai cadere a terra
base in alluminio, peso Kg.10
facilmente spostabile sul campo**

The basket is adjustable from horizontal to
nearly vertical, height adjustable from 175
to 262 cm. - aluminium base, weight 10 Kg.
very easy to move on the field, never falls
down when hit by the ball



RETI DI PROTEZIONE - Protection nets



TUTTE LE RETI DI PROTEZIONE VENGONO REALIZZATE SU MISURA IN BASE ALLE RICHIESTE DEL CLIENTE IN CIRCA 10 GIORNI

All protection nets are manufactured according to Customer's needs in about 10 days

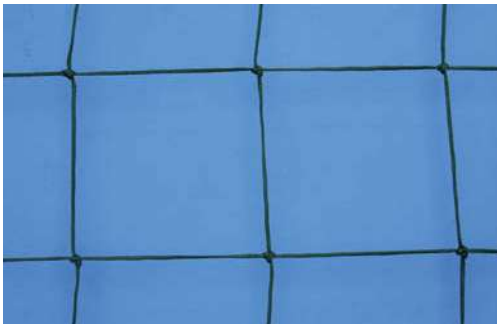

● pg.29

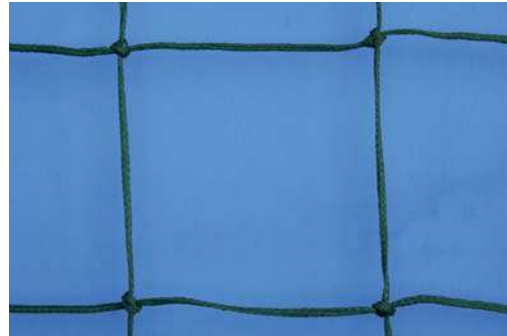

Art. 093N

**Rete protezione polietilene verde annodata
maglia cm. 13x13 spessore mm.2,5
(per calcio e calcetto)**

Protection Net green polyethylene mesh
13x13 cm. knotted, thickness 2,5 mm.
(for football and futsal)

Art. 093.5

**Rete protezione polietilene verde annodata
maglia cm. 13x13 spessore mm.3,5
(per calcio e calcetto)**

Protection Net green polyethylene mesh
13x13 cm. knotted, thickness 3,5 mm.
(for football and futsal)

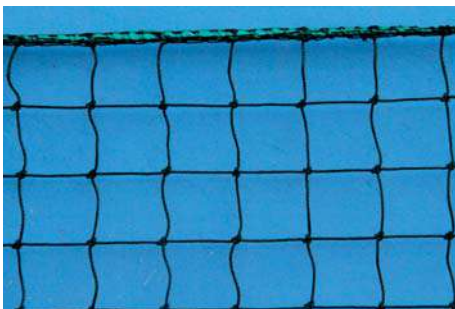

Art. 0934N

**Rete protezione polietilene verde annodata
maglia mm. 45x45 sp. mm.2
(per tennis e baseball)**

Protection Net green polyethylene mesh
45x45 mm. knotted, thick 2 mm.
(for tennis and baseball)

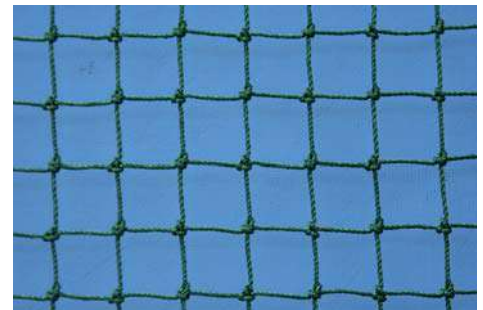

Art. R55

**Rete protezione polietilene
nera annodata
maglia mm. 18x18
spessore mm.2
(antioggetto/antipetardo)**

Protection Net mesh 18x18 mm.
anti-objects and firecrackers

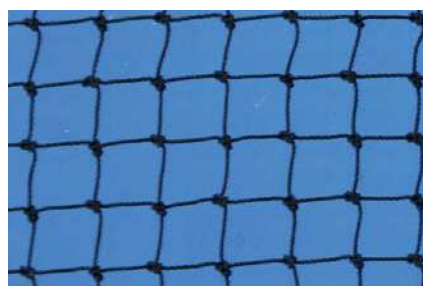

Art. R57

**Rete protezione polietilene
verde annodata
maglia mm. 25x25
spessore mm.2 (per golf)**

Protection Net
green polyethylene mesh 25x25 mm.
knotted thick 2 mm. (for golf)

PANCHINE ALLENATORI - Trainers' dugouts



Art. V6230/.../V6234.8
Panchina allenatori
profilo curvato
mm. 50x30 in acciaio
zincato a caldo
rivestimento
posteriore e laterale
in policarbonato
alveolare non
trasparente spessore
mm. 4,
piano di seduta con
scocche in
polipropilene montate
su telaio zincato
Dugout in galvanized
steel with non
transparent alveolar
protection

Altezza tettuccio cm. 200, profondità fianco laterale cm. 88

pg.30

Art. V6220/.../V6224.8
Panchina allenatori
profilo curvato
mm. 50x30 in acciaio
zincato a caldo
rivestimento
posteriore e laterale in
policarbonato
trasparente spessore
mm. 3, piano di seduta
con scocche in
polipropilene montate
su telaio zincato
Dugout in galvanized
steel with transparent
alveolar protection



Art. V6285
Protezione in poliuretano espanso
per bordo panchina allenatori
con profilo mm. 50x30 - da ordinare
all'acquisto delle panchine
Polyurethane protection for dugout's edge
to be added when ordering the dugouts



Altezza tettuccio cm. 200
profondità fianco laterale cm. 74
 Roof height 200 cm. - side depth 74 cm.



Art. 155AV/156AV/157AV/158AV/159AV/159.7AV/159.8AV/155AV4
Panchina allenatori con struttura in tubo quadro in lega d'alluminio mm. 30x30 con copertura in policarbonato alveolare non trasparente - fianchi laterali in policarbonato trasparente (2 scocche di seduta in polipropilene per ogni metro di lunghezza)
 Dugout in light alloy square pipe mm. 30x30 with non transparent alveolar protection
 Transparent protection on both sides (2 polypropylene seats per every meter of length)

● pg.31



Art. 162
Protezione in EVA per bordo panchina
 EVA protection for dugout's edge



Art. PSG1/PSG2/PSG3
Piano di seduta con scocche in polipropilene montate su supporto in acciaio zincato da fissare a terra
 (identico a quello fornito con le panchine allenatori serie Art. 155AV e Art. 155)
 lunghezza m.1 con 2 scocche di seduta
 lunghezza m.2 con 4 scocche di seduta
 lunghezza m.3 con 6 scocche di seduta
 Seating support mounted on a galvanized frame

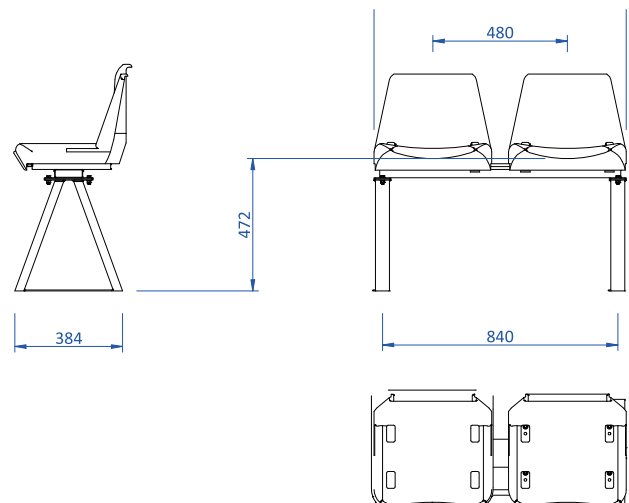
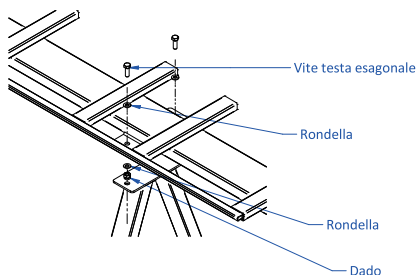



Altezza tettuccio cm. 200 profondità fianco laterale cm. 74
Roof height 200 cm. - side depth 74 cm.



Art. 155/156/157/158/159/159.7/159.8/155-4

Panchina con struttura in tubo quadro in lega d'alluminio mm. 30x30 con copertura in policarbonato trasparente e scocche di seduta in polipropilene (2 scocche di seduta per ogni metro di lunghezza)

Dugout in light alloy square pipe mm. 30x30 with transparent polycarbonate protection (2 polypropylene seats per every meter of length)

pg.31

*La verniciatura con colore a richiesta del tubo quadro in alluminio comporta una maggiorazione del prezzo del 10%
Optional painting of the square pipe frame in aluminium (color on request): 10% additional charge on selling price*



pg.32

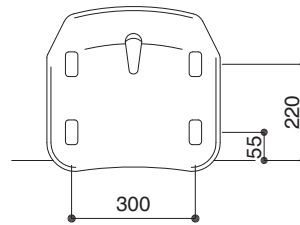
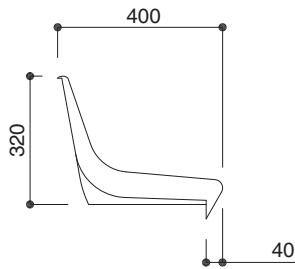

Art. M2010
Seduta ricambio per panchina allenatori (nuovo modello) colore rosso o blu
Spare Seat for Dugouts (new model) in red or blue color



Art. ASBI
Seduta ricambio per panchina allenatori (vecchio modello) colore rosso o blu fissaggio con 4 viti
Spare Seat for Dugouts (previous model) in red or blue color fixing with 4 screws

pg.31

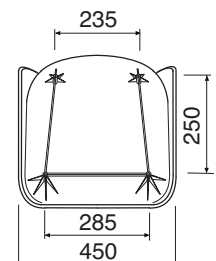
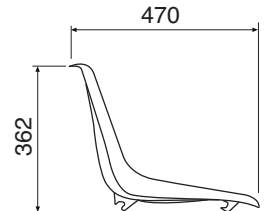

*È necessario fissare le panchine su una base in cemento tramite tasselli: la base dovrà essere più estesa di circa 30 cm. per ciascun lato rispetto alla lunghezza e alla profondità della panchina
It is necessary to anchor dugouts upon concrete base. Size of concrete base must be about 60 cm. longer and deeper than dugout perimetric size (30 cm. longer and wider on each of the 4 sides)*

PANCHINE ALLENATORI IDEALI PER CAMPI CALCETTO Trainers' dugouts for futsal pitches



Art. V6242.2 / V6242.3 / V6241.2 / V6241.3

Panchina allenatori profilo curvato mm. 40x20 in lega di alluminio, rivestimento posteriore e laterale in policarbonato alveolare sp. mm. 4 profondità a terra cm. 97, altezza massima cm. 208 lunghezza metri 2 oppure metri 3 con panca sedute in acciaio zincato e legno o con panca sedute in alluminio anodizzato

Dugout curved profile 40x20 mm. in light alloy, rear and side coverings in non transparent polycarbonate 4 mm. thick soil depth 97 cm. maximum height 208 cm. 2 meters or 3 meters length with wooden bench on galvanized steel or with bench in anodized aluminium



● pg.32

Art. V6291 / V6292

Panchina allenatori trasportabile su ruote profilo curvato mm. 50x30 in lega di alluminio rivestimento posteriore e laterale in policarbonato alveolare sp. mm. 4 oppure in policarbonato trasparente sp. mm. 3, profondità a terra cm. 150 altezza utile cm. 210 lunghezza metri 3 con supporto sedute in acciaio zincato e 6 scocche in polipropilene con piano borse sul retro dei seggiolini

Dugout transportable on wheels curved profile 50x30 mm. in light alloy rear and side coverings in non transparent polycarbonate mm. 4 thick or in transparent polycarbonate mm. 3 thick, depth on the ground 150 cm. useful height 210 cm. length 3 meters with galvanized steel seat support and 6 polypropylene seats with back space for bags





Profondità fianco laterale cm.150
Side depth 150 cm.

**Ordinabile anche nel modello fisso
senza ruote**
Fixed model with no wheels on request

pg.32

Art. V6293 / V6294

**Panchina allenatori trasportabile su ruote lunghezza metri 3
profilo curvato mm.50x30 in lega di alluminio - altezza utile cm.210
copertura in policarbonato alveolare mm.4 oppure in policarbonato trasparente mm.3
sedute su 2 file (11 posti in totale)**

Transportable dugout on wheels length 3 meters
aluminium alloy frame 50x30 mm. - height 210 cm.
4 mm. non transparent polycarbonate cover or 3 mm. transparent polycarbonate cover
seating in 2 rows (11 seats in total)



Art. S04910

**Panchina bordo campo
struttura in acciaio zincato
lunghezza cm. 200
con 4 scocche di seduta in polipropilene colorato**
4 Sideline seats on galvanized steel frame
length 200 cm.

pg.43



Art. 155FZ2/155FZ4/155FZ6/155FZ8

Panchina allenatori in acciaio zincato a caldo rinforzato profilo mm. 40x40 con profondità cm.180 (misurando da tettuccio a limite base posteriore di appoggio) rivestita con lastre in policarbonato trasparente spessore mm. 3 piano di seduta con scocche in polipropilene

Dugout in galvanized steel pipe 40x40 mm. - 180 cm. depth (from back protection to edge of roof)
transparent polycarbonate 3 mm. thick back cover - polypropylene seats on steel frame (2 seats each meter)



● pg.31 ● pg.32

Art. 155PR

Rivestimento di protezione in schiumato per tettuccio e montanti
Soft edge protections



Art. LXR2/LXR4/LXR6/LXR8

Panchina allenatori in tubo di acciaio zincato a caldo profilo mm. 40x40 TRASPORTABILE su ruote - copertura in policarbonato trasparente profondità cm. 135 piano di seduta con scocche in polipropilene

Dugout in galvanized steel pipe 40x40 mm. - TRANSPORTABLE on wheels
transparent polycarbonate back cover, polypropylene seats

PANCHINE LUSO CON POLTRONE IN ECOPELLE - Leather seat dugouts



**PREVENTIVO SU RICHIESTA
PRICES ON REQUEST**



**Modelli fissi o trasportabili
struttura in acciaio zincato
poltrone in ecopelle personalizzabili**
Fixed or transportable Dugouts
galvanized steel frame
customizable leather seats

CARRELLI TRACCIALINEE - Line markers



Per una resa ottimale e per evitare inconvenienti utilizzare sempre carbonato di calcio asciutto, ovvero la comune polvere di marmo

For optimal performance always use dry calcium carbonate, that is the common marble dust

Art. 142S
Carrello traccialinee a polvere
Marble Powder Line Marker

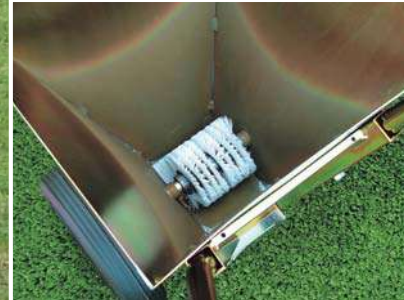

pg.29

UTILIZZARE SOLTANTO VERNICE ECOLOGICA ATOSSICA E PULIRE DOPO OGNI USO IL SERBATOIO E TUTTO IL CIRCUITO DI SPRUZZO FINO AGLI UGELLI (occorre spruzzare ripetutamente acqua prima di riporre l'attrezzo)
Always use ecological paint and wash with water after use (put water in the tank and spray)

Si ricorda di eliminare le impurità della vernice con un setaccio e diluirla con acqua prima dell'uso
Remember to remove any paint impurities with a sieve and dilute it with water before use



Art. 144
Carrello traccialinee a vernice ecologica con serbatoio munito di sistema pompante a pressione manuale
Paint Line Marker with manual pressure tank



pg.30

Si ricorda di eliminare le impurità della vernice con un setaccio e diluirla con acqua prima dell'uso come indicato nel manuale di istruzioni
Remember to remove any paint impurities with a sieve and dilute it with water before use as indicated in the instruction manual

Art. 145
Carrello traccialinee a vernice ecologica con motore a scoppio a 4 tempi - marcatura CE serbatoio vernice litri 23 tracciatura laterale regolabile
Paint Line Marker with 4 stroke engine 23 liter tank adjustable lateral marking device



Art. 144.EL

Carrello traccialinee a vernice ecologica elettrico completo di caricabatteria (per la batteria della pompa elettrica) capacità serbatoio litri 18 tracciatura laterale regolabile

Electric Line Marker
complete with battery charger 18 liter tank
adjustable lateral marking device

Si ricorda di eliminare le impurità della vernice con un setaccio e diluirla con acqua prima dell'uso come indicato nel manuale di istruzioni
Remember to remove any paint impurities with a sieve and dilute it with water before use as indicated in the instruction manual

pg.30

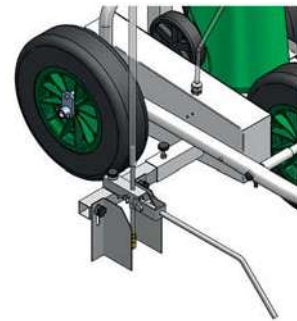

Art. F211

Mirino in acciaio zincato per carrelli traccialinee Art. 144.EL e Art. 145

Foresight in galvanized steel for line markers
Art. 144.EL and Art. 145



Art. 144.SL

Carrello traccialinee a rulli senza serbatoio a pressione. Tramite la rotazione dei rulli la vernice viene prelevata all'interno del serbatoio e spalmata sull'erba

Roller Paint Line Marker
Just fill up the tank with paint and push the machine.
Taking advantage of rolling wheels, paint flows from tank down to grass the easiest way

pg.29



Art. TE52030

Spazzolone cm. 200 per campi in erba sintetica con 4 spazzole da cm. 50, contrappesi laterali antivibrazione, manico in alluminio, setole in plastica dura, larghezza cm. 10

200 cm. Brush
for synthetic grass fields
with 4 brushes 50 cm.
anti-vibration lateral counterweights,
aluminum handle, hard plastic bristles,
width 10 cm.

pg.30



Art. 146E

Vernice Ecologica atossica per manti erbosi
Biancostadio lt. 17 - Kg. 19
 Ecological Paint for grass 17 liters - 19 Kg.



Art. NTESA
Rotolo Nastro adesivo mt. 50 - larghezza cm. 5
vari colori per tracciatura righe su superfici sintetiche lisce
 Tape for bounds
 50 meter - 5 cm. width

Art. SIFS

Fettuccia segnasettore in materiale sintetico impermeabile colore bianco o rosso
larghezza mm. 50 in rotoli da mt. 25 (chiodi inclusi)
 Sector line in waterproof synthetic fabric, width 50 mm. length 25 m. color white or red (pegs included)



pg.30

Art. 146BP/146BPG

Vernice bianca o gialla per manti sintetici a bassa permanenza (1 settimana) 17 litri
 Paint for artificial grass white or yellow color, short durability (1 week) 17 liters



Art. 146LP/146LPG

Vernice bianca o gialla per manti sintetici a lunga permanenza (3 mesi) 17 litri, da utilizzare solo con carrello a rulli
 Paint for artificial grass white or yellow color, long durability (3 months) 17 liters



Art. NS200

Rotolo nastro stradale mt. 200 - bianco/rosso
 Red/White Tape length 200 meters



Art. PFIx Plifix

Picchetto di riferimento permanente con erba sintetica bianca o colorata per agevolare la tracciatura delle righe dei campi da gioco o per delimitare aree
Confezione da 25 pezzi incluso utensile in plastica
 Plifix - permanent peg with artificial white or coloured grass to help tracing lines on the field or mark areas - 25 pieces set includes also plastic planting device



Art. RC100

Bobina con fettuccia elastica per delimitazione temporanea campo da gioco.

Con questo nastro la marcatura può essere comodamente installata su campi senza gesso o vernice, e può essere rimossa senza lasciare residui dopo una partita o un allenamento. Il nastro può essere facilmente srotolato dalla bobina, e poi riavvolto con la stessa facilità. Lunghezza 100 metri (ma può estendersi fino a circa il doppio)

Larghezza cm. 2,5 - colore bianco
25 picchetti in plastica inclusi per il fissaggio

Spool with elastic tape for temporary delimitation of the playing field. With this tape the marking can be conveniently installed on pitches with no chalk or paint, and can be removed without leaving residue after a match or training. The tape can be easily unwound from the spool, and then rewound just as easily.

Length 100 meters (but can extend to approximately double that)

Width 2,5 cm. - white color
 25 plastic pegs included for fixing

SEDUTE PER GRADINATE - Stadium seats

COLORI DISPONIBILI: blu, rosso, giallo, verde, bianco, nero, grigio
AVAILABLE COLORS: blue, red, yellow, green, white, black, grey

ORDINE MINIMO 10 PEZZI PER MODELLO E COLORE
 Minimum quantity 10 pieces per model and color

**ATTENZIONE:
 NON PER PANCHINE
 ALLENATORI!
 NOT FOR TRAINERS'
 Dugouts!**



Art. M2003/M2003A

Art. M2003 Seduta in polipropilene con schienale ignifuga e antiultravioletti secondo normativa UEFA fissaggio diretto sulla gradinata con tasselli (non inclusi)
 Polypropylene Seat non ignitable and anti-ultraviolet rays with back rest according to UEFA requirements to be fixed with screws (not included)

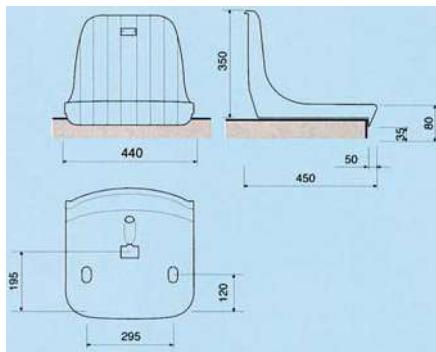

Art. M2003A Seduta in polipropilene con schienale come Art. M2003 solo antiultravioletti, fissaggio diretto sulla gradinata con tasselli (non inclusi)
 Polypropylene Seat as Art. M2003 anti-ultraviolet rays, with back rest to be fixed with screws (not included)

pg.32

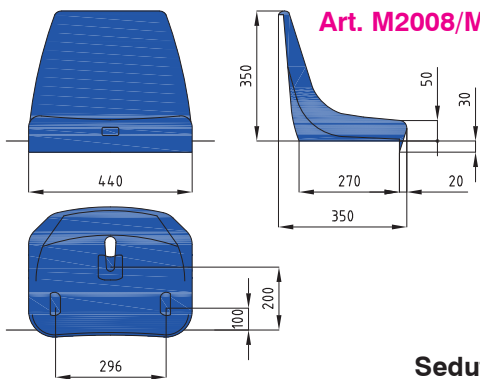

Art. M2008/M2008A



Seduta in polipropilene con schienale ignifuga e antiultravioletti Art. M2008 oppure solo antiultravioletti Art. M2008A - fissaggio diretto sulla gradinata con tasselli (non inclusi)
 Polypropylene Seat non ignitable and anti-ultraviolet rays **Art. M2008** or only anti-ultraviolet rays **Art. M2008A** with back rest to be fixed with screws (not included)

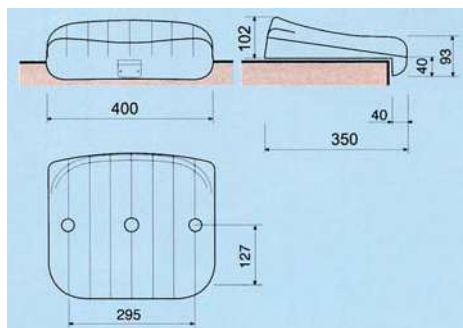
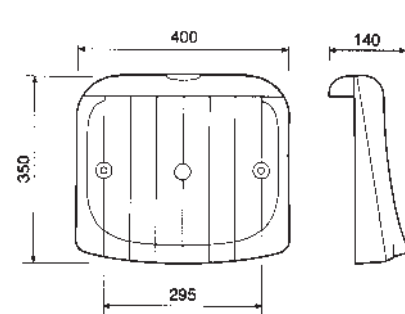

Art. M90/M90.A

Art. M90 Seduta in polipropilene senza schienale ignifuga e antiultravioletti fissaggio diretto sulla gradinata con tasselli (non inclusi)

Polypropylene Seat non ignitable and anti-ultraviolet rays, without back rest - to be fixed with screws (not included)

Art. M90.A

Seduta in polipropilene senza schienale come Art. M90 solo antiultravioletti fissaggio diretto sulla gradinata con tasselli (non inclusi)

Polypropylene Seat as Art. M90 anti-ultraviolet rays, without back rest - to be fixed with screws (not included)

pg.32

TRIBUNE - Stands

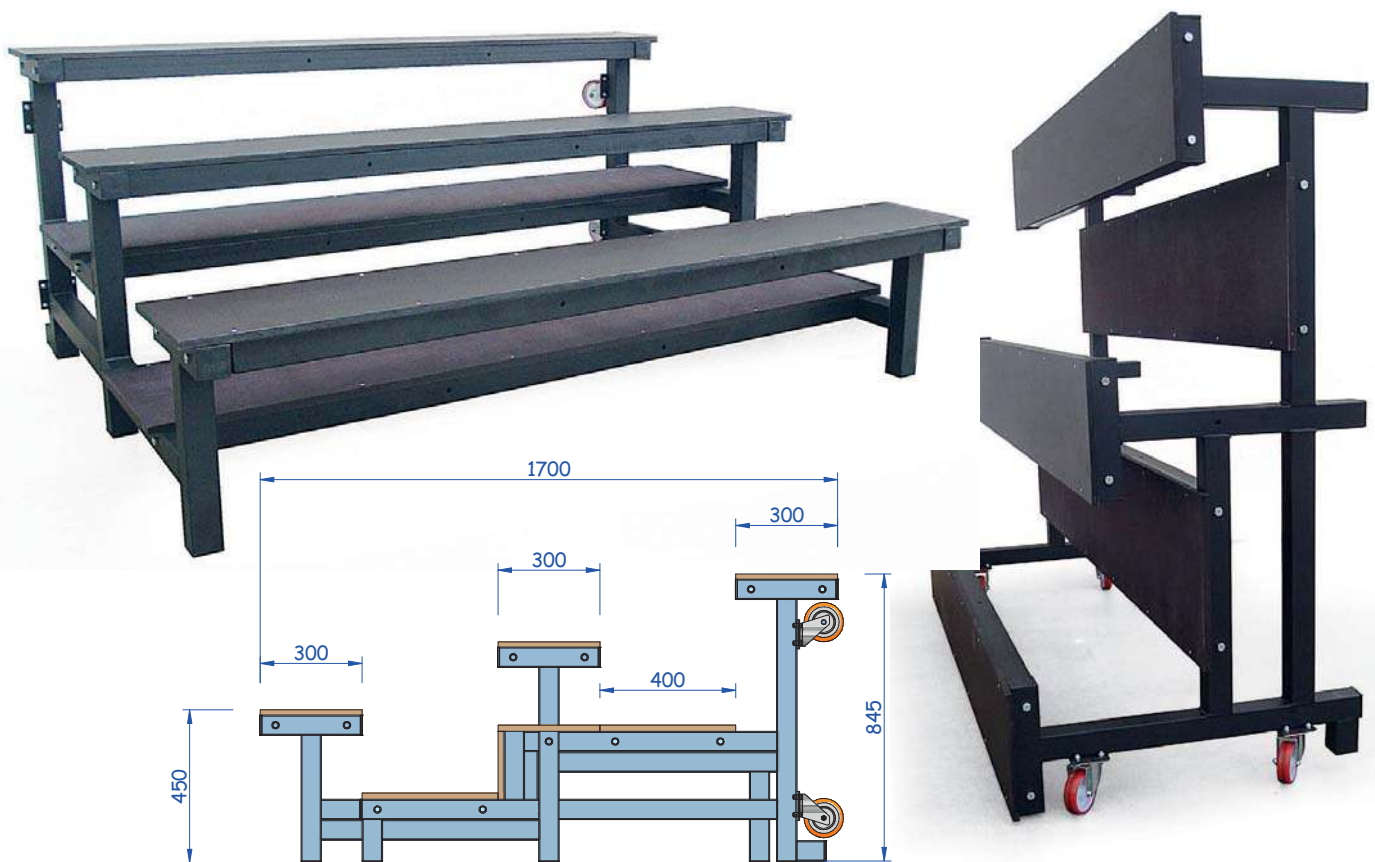

Art. G12005

Modulo Tribuna per interno/esterno su 3 file in acciaio zincato trasportabile su ruote, piani di seduta in carply, lunghezza m. 2,5

Indoor/outdoor Stand in galvanized steel, 3 rows, movable on wheels, with wooden benches

pg.33



Art. G12006

Modulo Tribuna per interno/esterno su 3 file in acciaio zincato trasportabile su ruote, piani di seduta con scocche in polipropilene, lunghezza m. 2,5

Indoor/outdoor Stand in galvanized steel, 3 rows, movable on wheels, with polypropylene seats

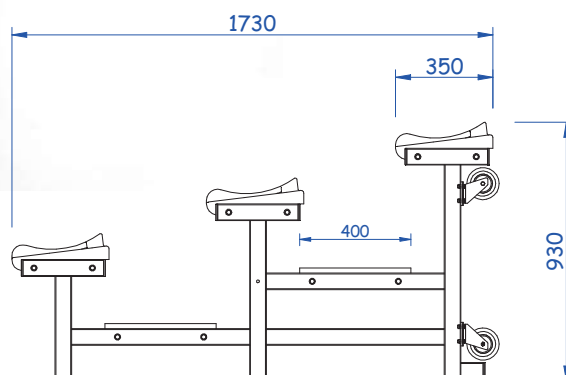



Art. G120TM
Tribuna telescopica da interno
con sedute in polipropilene
Telescopic Stand for indoor
with polypropylene seats

pg.33



Art. S07700
Transenna in
acciaio zincato
cm. 200x100h.
Galvanized steel barrier 200x100 cm.



pg.33

Art. S07710
Transenna in plastica cm. 215x90h.
con piedi di appoggio
a terra ruotabili, con banda
catarifrangente e sistema di
aggancio a catena
Plastic barrier 215x90 cm.

ARREDI PER SPOGLIATOIO - Dressing Room Benches



Art. S07326 / S07324
Tavola appendiabiti
con grucce m.1 / m.2
Clothes hanger board m.1 / m.2

Art. S07322 / S07320
Tavola appendiabiti con tettuccio lunghezza m.1 / m.2
Clothes hanger board with bag holder m.1 / m.2

Art. S902.1E / S902.2E
Panca in acciaio verniciato
con listoni in legno m.1 / m.2
con schienale e appendiabiti
Bench in painted steel and
wood length m.1 / m.2
with back rest and clothes hanger board



Art. S07308 / S07306
Panca in acciaio verniciato
con listoni in legno
m.1 / m.2 con schienale
Bench in painted steel and
wood length m.1 / m.2
with back rest

Art. S07304 / S07302
Panca in acciaio verniciato
con listoni in legno m.1 / m.2
Bench in painted steel and
wood length m.1 / m.2

pg.33



Art. S07406 / S07404
Pedana poggiapiedi a listoni
in legno lunghezza m.1 / m.2
Footrest in wood length m.1 / m.2

Art. S07312 / S07310
Panca con schienale, appendiabiti e
portaborse in acciaio verniciato
con listoni in legno
lunghezza m.1 / m.2
Complete Bench
in painted steel and
wood length m.1 / m.2



Disponibile
anche lunghezza
m. 1,5
(al prezzo della
lunghezza m. 2)
Also available
length 1,5 m.
(at the same price
as length 2 m.)

Art. S07313/S07314
Panca completa
ad isola per centro
locale m.1 / m.2
in acciaio verniciato
con listoni in legno
Double bench
in painted steel and
wood length
m.1 / m.2



Colore standard del telaio in acciaio: rosso o blu.
Altri colori su preventivo
Standard color of the steel frame: red or blue.
Other colors on quote



Art. V8626 / V8627
 Panca con schienale, appendiabiti e portaborse in alluminio anodizzato con inserti in PVC lunghezza m. 1 oppure lunghezza m. 2
 Complete Bench in anodized aluminium length m. 1 or length m. 2

pg.34

Art. V9092 / V9093
 Pedana poggiapiedi in alluminio anodizzato lunghezza m. 1 oppure lunghezza m. 2
 Footrest in anodized aluminium length 1 or 2 meters

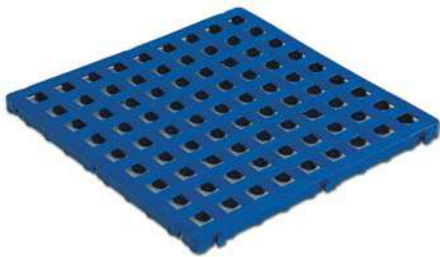

Art. S07408
 Pedana poggiapiedi in plastica cm. 50x50
 Plastic footrest 50x50 cm.



Art. S07434
 Graticcio per doccia in legno cm. 60x60
 Wooden footrest 60x60 cm.



Art. S07466
 Asciugacapelli elettrico con temporizzatore e tubo flessibile
 Hair dryer with timer and flexible pipe



Art. S07458
 Asciugamani elettrico con temporizzatore
 Hand dryer with timer



Art. TPD Poggiapiedi Footsy idrorepellente
 Foldable foot rest waterproof



Art. S07462
 Asciugacapelli elettrico con temporizzatore
 Hair dryer with timer

ARMADIETTI PER SPOGLIATOIO - Dressing Room Lockers



Art. S07226
Armadio casellario a 15 posti in lamiera verniciata - dim. vano cm. 35Lx35px35h
dimensioni totali cm. 103Lx35px180h
15 boxes sheet metal filing cabinet

pg.35



Art. MAP30
Armadio portavalori a 30 sportelli
dim. cm. 95Lx20px50h con serrature
Safe-deposit locker with 30 boxes

Art. MAP50
Armadio portavalori a 50 sportelli
dim. cm. 95Lx20px82h con serrature
Safe-deposit locker with 50 boxes



Armadi in laminato - HPL panels

Art. S07252 / S07254 / S07256
Armadio spogliatoio in laminato
dim. vano cm.30Lx50px90h
1 colonna 2 vani
2 colonne 4 vani
3 colonne 6 vani
Laminated Lockers

Art. S07258 / S07260 / S07262
Armadio spogliatoio in laminato
dim. vano cm.30Lx50px180h
1 colonna 1 vano
2 colonne 2 vani
3 colonne 3 vani
Laminated Lockers

ACCESSORI PER SPOGLIATOIO ED INFERMERIA Dressing room and infirmary accessories



Art. S07448
Specchio a parete
con cornice in plastica
diametro cm. 50
Wall mirror with frame
diameter 50 cm.

Art. S07438
Distributore di sapone
liquido a parete
Wall soap dispenser



Art. S07442
Distributore di salviette a parete
Wall towel dispenser



ALTRI ARTICOLI SUL
LISTINO PREZZI



Art. S07412
Tavolo per
spogliatoio e
locale arbitri
cm. 80x80x76
Locker room
table
80x80x76 cm.

pg.34



Art. S07416 Bacheca
con struttura in alluminio cm. 120x90
Bulletin Board 120x90 cm.

Art. S07414
Sedia in acciaio cromato
scocca in polipropilene
Chromed steel chair
with polypropylene seat



Art. S07418
Portaombrelli a 24 posti
in acciaio verniciato
Steel umbrella stand



Art. S07715 Spazzolone
per pulizia e asciugatura
area pubblica e campo di gioco
Scrubber for cleaning playcourt



Art. S07102 / S07104
Armadio a vetri a una o due ante
Glass Cabinet with one or two doors



Art. S07106 Paravento a tre ante
struttura in acciaio cromato
Three shutter foldable screen



Art. S07138
Cassetta medica
da fissare a parete
secondo D.M. 388
First aid kit



Art. S07136
Cassetta medica
portatile
secondo D.M. 388
First aid kit

ALTRI ARTICOLI SUL
LISTINO PREZZI

pg.34 pg.35



Art. S07128
Scaletta scendiletto
in acciaio cromato
Bedside step



Art. S07124
Sgabello girevole
in alluminio
Turnable stool



Art. S07108
Appendiabiti a colonna
in acciaio cromato
Clothes stand



Art. S07132
Cestino in plastica
Plastic trashcan

Art. S07130
Portarifiuti
a pedale
in acciaio
verniciato
Metal trashcan



Art. S07134
Portantina pieghevole
in acciaio cromato
Foldable Stretcher in
chromed steel



Art. S07110
Scrivania con cassetiera
dim. cm.130x76x78
Desk with 3 drawers dimensions 130x76x78 cm.

Art. S07114

Sedia imbottita in acciaio cromato Chair in chromed steel



Art. S07410
Tavolo per massaggi in acciaio imbottito in similpelle
Massage table



Art. PTI.BIL
Bilancia pesapersona digitale con indicazione massa grassa (ad esaurimento)
Digital scales body fat measurer (until available)

pg.34

pg.35



Art. 3031S
Lettino Antero chiudibile testiera regolabile
cm.180x60x73
peso Kg.20
colore nero
in acciaio cromato
Medical couch foldable in chromed steel

Art. 3033S
Borsone porta lettino Antero
Bag for Art. 3031S

Art. S07118
Portarotolo
Paper roll holder

Art. S07120
Rotolo carta
Paper roll



Art. S07116
Lettino visita medica imbottito con testiera reclinabile
Medical couch in chromed steel, padded, adjustable headrest

TUNNEL USCITA SPOGLIATOI - Stadium tunnels

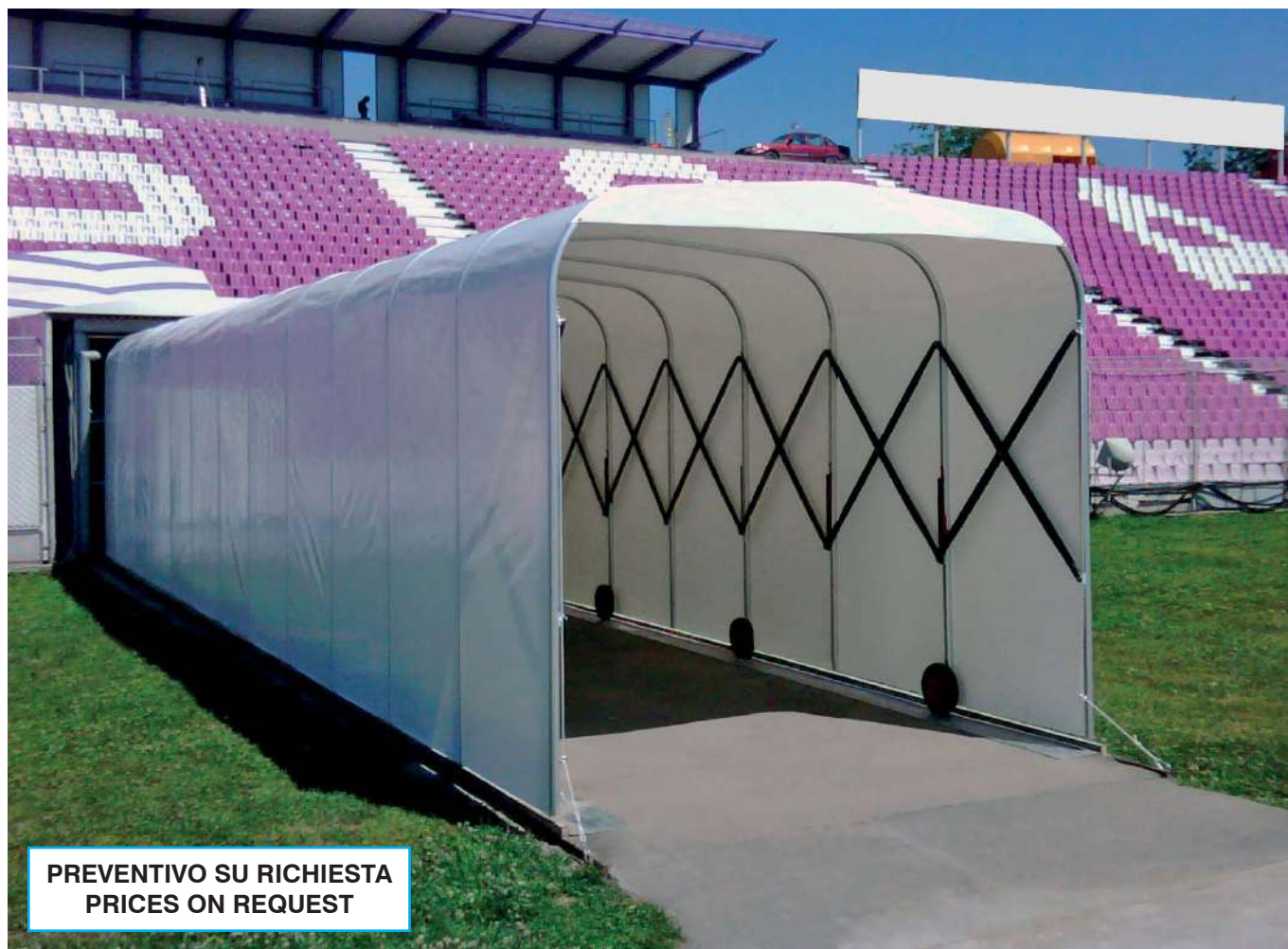

Art. 160 Tunnel estensibile struttura in lega d'alluminio, copertura in PVC ignifugo Cl.2 bianco o colorato, montato su ruote in nylon o pneumatiche, dimensioni standard (personalizzabili): larghezza cm.200, altezza al centro cm.232, altezza ai lati cm.200, in moduli da un metro
Extensible Tunnel in light alloy covered by fireproof PVC Cl.2, white or coloured, movable on nylon or pneumatic wheels - Standard dimensions 200 cm. width, 232 cm. height in the middle, 200 cm. height at the sides - made of one meter segments joined together



**Lunghezza, larghezza
e altezza
personalizzabili su richiesta**
Any dimension available
on request

BEACH SOCCER



Art. PBSFS

Coppia Porte Beach Soccer m. 5,5x2,2 in lega d'alluminio tubo sezione mm. 80 verniciate in giallo con bussole a croce
Pair of Beach Soccer goals in aluminium 5,5x2,2 m. - pipe 80 mm. painted yellow with sockets

Bussola
Socket

Art. PBSTR Coppia Porte Beach Soccer m. 5,5x2,2 in lega d'alluminio tubo sezione mm. 80 verniciate in giallo trasportabili

Pair of Beach Soccer goals in aluminium 5,5x2,2 m. pipe 80 mm. painted yellow transportable

Art. 110BS

Coppia Porte Beach Soccer m. 5,5x2,2 in lega d'alluminio tubo sezione mm. 120x100 verniciate in giallo con estensione dei pali da insabbiare (senza bussole)
Pair of Beach Soccer goals in aluminium 5,5x2,2 m. - pipe 120x100 mm. painted yellow with extension of posts (with no sockets)



Art. 073BS

Kit 10 paletti completi per Beach Soccer (6 bandierine rosse e 4 bandierine gialle)
Kit of 10 Beach Soccer Poles (6 red flags and 4 yellow flags)

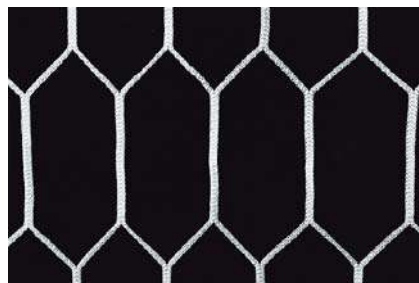

Art. RBS Coppia reti per porte Beach Soccer m. 5,5x2,2 in polipropilene
Pair of polypropylene nets for Beach Soccer goals 5,5x2,2 m.



Art. KDBS Kit Delimitazione per campo Beach Soccer, colore royal: 2 nastri m. 28 + 2 nastri m. 37 larghezza mm. 80 + 8 picchetti e 8 elastici
Kit for Beach Soccer bounds



Art. PGRBS

Pallone Gems Raptor Beach Soccer in pelle sintetica n.5 cucito a mano
Beach Soccer Ball Gems in synthetic leather size 5

TAVOLI CALCETTO - Soccer tables



Art. F3FOLDY
Tavolo calcetto in acero
dim. cm.137x92x81h Kg.26
aste telescopiche e gambe ripiegabili
ideale per bambini
Soccer table for children



Art. JKBOM
Tavolo calcetto Bomber
senza gettoniera
aste telescopiche,
piano in vetro temperato
colore blu o bianco
Soccer table Bomber

pg.45



Art. IS432
Confezione 10 palline
per tavolo calcetto
10 Soccer table balls



Art. G500
Tavolo calcetto da esterno
G500 Weatherproof
con aste telescopiche
Soccer table G500 for outdoor

Da esterno



Art. FTGO.G
Tavolo calcetto modello Pride
con gettoniera, aste cromate telescopiche,
gambe in ferro verniciato,
mobile in multistrato, peso Kg. 73
Soccer table model Pride with coin slot
telescopic, legs in painted steel, weight 73 Kg.

Art. FTEC
Tavolo calcetto modello Pride
con vetro protettivo
ad alta resistenza, peso Kg. 85
Soccer table model Pride with high resistance
safety glass, weight 85 Kg.

BASKET

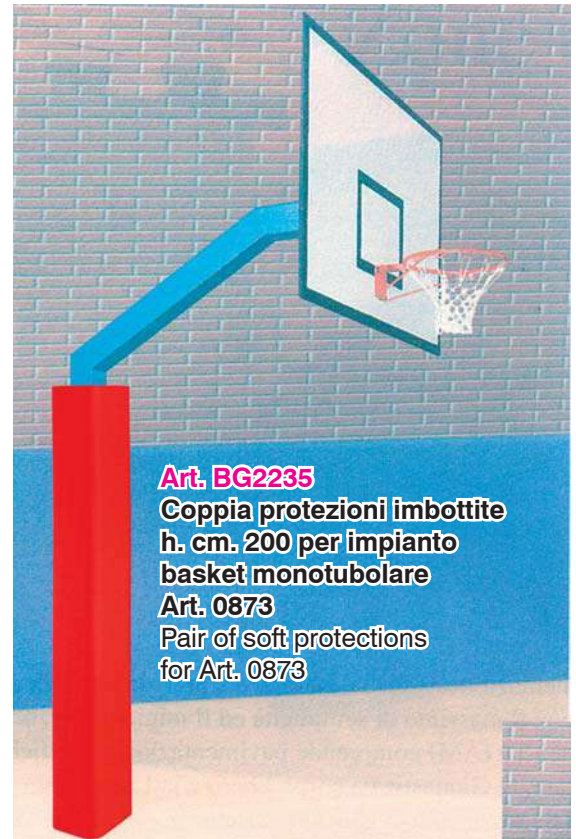

pg.35





Art. S04056 / S04058

Impianto basket a muro fisso con sbalzo cm. 185 oppure cm. 325, tabelloni in bilaminato, canestri e retine
Wall basketball system projection 185 cm. or 325 cm. wooden boards, rings and nets



Art. S04151

Impianto minibasket a muro fisso, sbalzo cm. 80, tabelloni in bilaminato canestri e retine
Wall mini-basketball system projection 80 cm.



Art. S04152

Impianto minibasket a muro fisso, sbalzo cm. 185 tabelloni in bilaminato canestri e retine
Wall mini-basketball system projection 185 cm.



Art. S04150

Impianto basket/minibasket a muro regolabile in altezza tabelloni in polipropilene con canestri e retine
Wall basketball/mini-basketball system adjustable height



Art. S04161

Art. S04162

Art. S04161

Coppia strutture minibasket agganciabili a tabelloni basket complete di tabelloni in bilaminato, canestri e retine (carrello per sollevamento strutture Art. S04162 non incluso)

Pair of mini-basketball constructions to be attached to basketball boards (lifting trolley Art. S04162 not included)



Art. 647B Minibasket a colonna regolabile in altezza da cm. 168 a cm. 229 trasportabile con canestro e retina tabellone cm. 90x60 Minibasket adjustable height from 168 cm. to 229 cm. transportable



Art. 26759 Basket a colonna regolabile in altezza da cm. 229 a cm. 305 trasportabile con canestro e retina tabellone cm. 120x70 rinforzato Basket adjustable height from 229 cm. to 305 cm. transportable



Art. 26760 Tabellone minibasket in plastica da fissare al muro, fornito con canestro e retina Wall minibasket board



pg.35

pg.36



Art. S04012 Struttura basket e minibasket richiudibile e trasportabile in acciaio verniciato, base porta zavorra, tabellone in resina, canestro fisso e retina, protezione frontale Transportable and foldable Basket/Minibasket in painted steel, resin board, front protection



Art. F126BSK Set Baskin trasportabile altezza regolabile fino a cm. 220 tabellone cm. 110x73 base zavorrabile su ruote Transportable Baskin adjustable height until 220 cm.



Art. F102
Canestro Basket regolamentare
 (retina esclusa)
 Basket standard



Art. F103
Canestro Basket rinforzato
 (retina esclusa)
 Basket reinforced



Art. F105
Canestro Basket zincato
 (retina esclusa)
 Basket galvanized



Art. B030
Coppia Retine in nylon
 mm. 3,5
 Pair of nets 3,5 mm.



Art. B050
Coppia Retine in nylon
 mm. 6
 Pair of nets 6 mm.



Art. B060
Coppia Retine in cotone
 mm. 7
 Pair of nets 7 mm.



Art. R122
Coppia Retine in acciaio
 Pair of steel nets



Art. F106
Canestro Basket reclinabile, a norme FIBA
 (retina esclusa)
 Reclining Basket

pg.36

Art. NRG
Set 12 ganci reggirete in plastica per canestro basket
 Set 12 plastic basket net holders

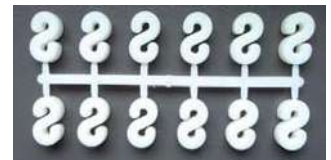

Art. S04202 - S04214 - S04204 - F116/B - S04216
Coppia tabelloni in bilaminato per interno oppure in resina melaminica per esterno - varie dimensioni
 Pair of basketball boards in chipboard for indoor or in resin for outdoor - various sizes

Brevettato
Patented

Art. F109
Canestro Basket reclinabile frontalmente e lateralmente (retina esclusa)
 Front/Side reclining Basket

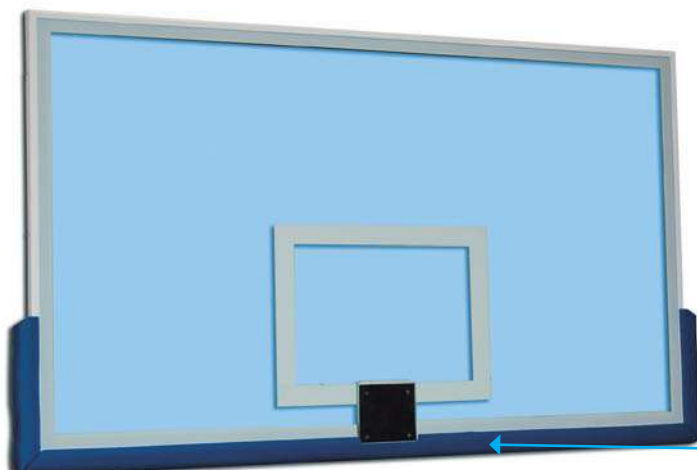

Art. S04206 / S04208
Coppia tabelloni in Plexiglass trasparente oppure in cristallo temperato dimensioni cm. 180x105 - compreso telaio e protezione
 Pair of basketball boards in transparent acrylic or tempered glass 180x105 cm. mounted onto varnished steel frame with pads

Art. B2063B / B2063
Coppia Protezioni sottocanestro omologate FIBA e non
 Pair of soft board protection pads FIBA approved or not



Art. S04266

Art. S04254
Panca per atleti e riserve con schienale m.3
 Bench length 3 meter with back rest

Art. S04266
Protezione posteriore mobile per tavolo giuria e per panche atleti in policarbonato trasparente
 Transparent movable polycarbonate protection for benches and referees' table



Art. S04256
Tavolo giuria
 cm. 160x80x76h.
 Referee table

pg.36



Art. S04260
Tavolo per giuria cm. 300x70x76h.
 in acciaio verniciato e carenatura in legno, mobile su ruote
 Referee table on wheels



Art. S04288
Freccia indicatrice possesso palla
 Ball possession arrow



Art. F255
Freccia indicatrice elettronica possesso palla
 Electronic ball possession indicator



Art. F254
Segnalatore time out con impugnatura
 Time out indicator



Art. CR016
Cronometro contasecondi da tavolo a pila con display digitale
 Digital Table Clock for basketball



Art. CR005
Cronometro contasecondi da tavolo a pila con lancette
 Table Clock for basketball



Art. S04280
Segnapunti
manuale
girevole
a 6 cifre
6 figure
Scoreboard



Art. B01084
Segnapunti da tavolo per Basket
Table scoreboard



Art. S04274
Serie Palette per indicazione
manuale dei 24 secondi
Set of 24 sec indicators



Art. S04272
Serie Palette con supporti per
indicazione manuale dei falli di squadra
Set of referee's foul indicators



Art. S04282
Segnapunti manuale a parete a 6 cifre,
struttura in acciaio verniciato
Wall steel 6 figure scoreboard

pg.36 pg.37

Art. 089-B
Lavagna Basket
cancellabile cm. 40x23
Basket Tactical Board
erasable 40x23 cm.



Art. S04GD
Indicatore di allontanamento
dalla gara
Match expulsion indicator



Art. 087-B
Lavagna
Basket
magnetica
cancellabile
cm. 60x85
Basket Tactical
Board erasable
and magnetic
60x85 cm.

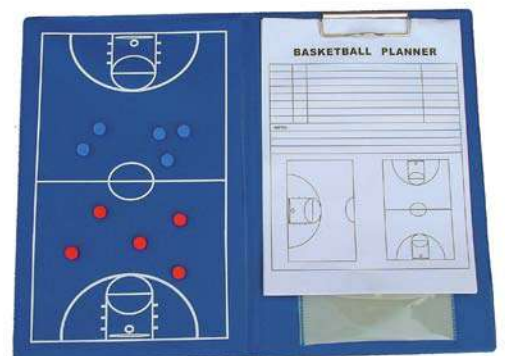

Art. LSRK
Lavagna Basket magnetica cm. 40x23
con block-notes (fino ad esaurimento)
Basket Tactical Board
magnetic 40x23 cm. with block-notes
(until available)

SKLZ >>



Art. SK.CVS

COURT VISION

Occhiali a visibilità limitata per allenamento al palleggio a testa alta, alla visione di gioco e alla reattività nei confronti dei difensori misura unica regolabile

Court vision dribble goggles force players to handle the ball with their head up to survey the court improve reaction time against defenders increase confidence on the court

SKLZ >>



Art. SK.KOT

KICK-OUT per ritorno palla dopo tiro a canestro, direzione regolabile

360° ball return system rotating chute returns made shots anywhere on the court easy twist adjustment with integrated handle



La fascia con le braccia gonfiate deve essere posizionata all'altezza delle spalle e, per installarla, può essere necessario sgonfiare moderatamente la sagoma. Successivamente, dopo avere rigonfiato, se la sagoma torna in posizione verticale con difficoltà si deve aggiungere dell'acqua nel serbatoio

pg.37

Art. KBVS

Kit braccia verticali per sagoma gonfiabile cm. 205 Art. SAG205

Raised arms kit for inflatable dummy 205 cm. Art. SAG205

Specifico per il Basket, il kit si installa facilmente sulla sagoma (non inclusa) e rende possibile una moltitudine di esercizi tecnico-tattici
Designed for Basket training, this kit is easily installed on the dummy (not included) and makes lots of technical and tactical exercises possible

SKLZ >>



Art. SK.DMAN

Sagoma Basket D-MAN

ad altezza regolabile da cm. 198 a cm. 243 con basamento riempibile,

munita di puntali per fissaggio anche su terreni naturali

Hands-up defensive mannequin ideal for solo practice or team settings portable, lightweight adjustable telescoping pole (from 198 cm. to 243 cm.) Weighted base - including spikes for natural grass anchoring



Art. SB4Y Pallone avviamento al Minibasket Molten gomma nylon size 4 Minibasket introduction ball



Art. BHAR5 / BHAR7 Pallone Basket e Minibasket gomma nylon size 5 (blu) - 7 (arancio) Nylon rubber Basket and Minibasket ball

pg.37



Art. SBPRO5 Pallone Minibasket Mondo SB-PRO size 5 gomma multistrato Multilayer rubber Minibasket Mondo SB-PRO size 5 ball



Art. B5G1600 Pallone Minibasket Molten B5G1600 size 5 gomma nylon (ex BGR5) Nylon rubber Minibasket Molten B5G1600 size 5 ball



Art. SBPRO7 Pallone Basket Mondo SB-PRO size 7 gomma multistrato Multilayer rubber Basket Mondo SB-PRO size 7 ball



Art. B7G1600/B6G1600 Pallone Basket Molten B7G1600/B6G1600 gomma nylon (ex BGR7/BGR6) Nylon rubber Basket Molten B7G1600/B6G1600 ball



Art. B7G3800/B6G3800 Pallone Basket Molten B7G3800/B6G3800 pelle sintetica FIBA Approved (ex BGM7X/BGM6X) Leather Basket Molten B7G3800/B6G3800 ball

Art. B7G4000/BGF6X Pallone Basket Molten B7G4000/BGF6X pelle sintetica ufficiale FIP Leather Basket Molten B7G4000/BGF6X ball



Art. B7G4500/B6G4500 Pallone Basket Molten B7G4500/B6G4500 pelle sintetica ufficiale FIP Lega Serie A (ex BGG7X/BGG6X) Leather Basket Molten B7G4500/B6G4500 ball



Art. TRBB Pallone reaction ball Trial rimbalzo e traiettorie imprevedibili per Basket (ad esaurimento) Trial Reaction Ball unpredictable rebounds (until available)



Art. ULTES60 Pallone Basket sonoro Goalball gomma Trial Ø cm. 24 gr. 1240 Sound rubber Trial Basket ball Goalball



Art. ULTS67 Pallone Basket gomma Trial allenamento potenziato Ø cm. 24 gr. 930 (+50%) Rubber Trial Heavier Basket ball

PALLAVOLO - Volleyball



Art. 6746T

Art. 6746T
 Impianto pallavolo
 monotubolare
 in acciaio zincato
 ø mm. 76
 completo di bussole
 da interrare cm. 40
 e tendirete,
 altezza della
 rete regolabile
 Volleyball posts in
 galvanized steel with
 underground sockets
 adjustable height net

pg.38



Art. V5003
 Impianto pallavolo
 monotubolare
 in acciaio zincato
 ø mm. 70
 completo di bussole
 da interrare
 e tendirete,
 con sistema
 telescopico
 per la regolazione
 della rete con doppia
 carrucola sulla
 sommità del palo
 Volleyball posts in
 galvanized steel with
 underground sockets
 telescopic posts
 adjustable height net



Art. V5009

Art. V5009
 Impianto
 pallavolo
 monotubolare
 in alluminio T6
 antiflessione
 mm. 120x100
 con arganello
 tendirete
 autofrenante
 e senza
 cremagliera
 con manovella
 asportabile
 bussole
 e tappi
 in alluminio
 Aluminium
 monotubular
 volleyball posts



Art. ARGC
 Arganello a
 cremagliera
 con manovella
 per impianto
 pallavolo
 monotubolare
 Spare rack
 winch for
 monotubular
 volleyball
 posts

Lato interno
 Inner side

Art. 6747/P
 Impianto pallavolo
 monotubolare a
 norme FIPAV
 in alluminio
 sezione
 mm. 120x100
 regolazione
 dell'altezza
 dei pali e della rete
 con sistema
 periscopico
 con arganello
 tendirete
 e bussole incluse
 Aluminium
 monotubular
 volleyball posts
 periscopic system
 FIPAV approved



Art. 6747/P

**La regolazione
 periscopica permette
 di variare l'altezza dei
 pali insieme a quella
 della rete (che può
 essere regolata da
 cm. 215 a cm. 243)**

**IMPIANTO
 = coppia pali
 (rete esclusa)**

Art. MB2083 Coppia
 Protezioni in gommapiuma
 rivestita per
 impianto monotubolare
 Pair of soft protections
 for volleyball posts



Art. 1009
Impianto pallavolo a traliccio in alluminio profilo sezione mm. 120x100 completo di ruote e tendirete
 Volleyball posts in aluminium transportable with wheels, pipe section 120x100 mm.



Art. MB2236
Coppia protezioni in gommapiuma rivestita per impianto a traliccio
 Pair of soft protections for volleyball posts



Lato interno
 Inner side



Art. V5020
Impianto pallavolo a traliccio ø mm. 70 in acciaio zincato completo di ruote e tendirete
 Volleyball posts in galvanized steel, transportable with wheels pipe section 70 mm.

Art. 6740R
Impianto pallavolo a traliccio ø mm. 70 in acciaio verniciato completo di tendirete e ruote
 Volleyball posts in painted steel with wheels pipe section 70 mm.



Art. 6752/T
Impianto Pallavolo a parete
 Volleyball posts for wall fixing

Art. 6752/P
Coppia protezioni per impianto Pallavolo a parete
 Pair of soft protections for volleyball posts for wall fixing

pg.38

pg.39

IMPIANTO = coppia pali (rete esclusa)

Art. V5029
Impianto pallavolo a tiranti ridotti in lega di alluminio profilo sezione mm. 120x100 con ruote per il trasporto piastra antitorsione alla base, arganello tendirete autofrenante senza cremagliera antinfortunistico
 Volleyball posts in aluminium transportable with wheels, pipe section 120x100 mm.





Art. E6532
Rete pallavolo economica m. 9,85
 Cheap net for volleyball

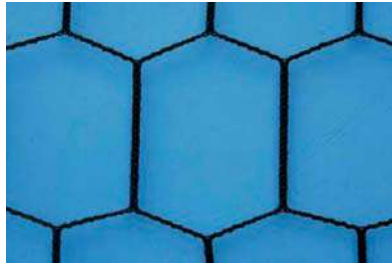

Art. P030
Rete pallavolo m. 9,50
 Net for volleyball

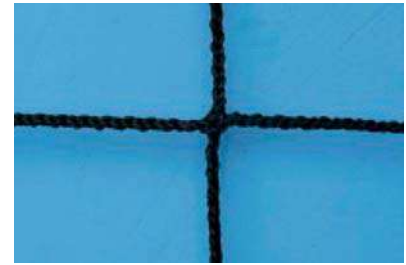

Art. P100
Rete pallavolo super pesante m. 9,50
maglia mm. 100
 Heavy net for volleyball

pg.39



Art. P110
Rete pallavolo extra pesante
m. 9,50 maglia mm. 100
a doppia fascia
 Heavy net for volleyball double band

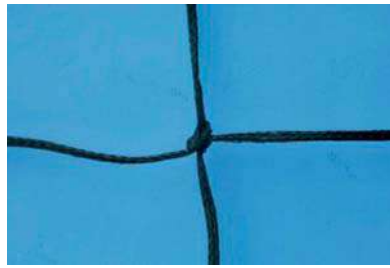

Art. P200
Rete pallavolo da gara
maglia mm. 100
con antenne e tasche
a norma FIPAV
 Official net for volleyball
 with sticks and fixing bands

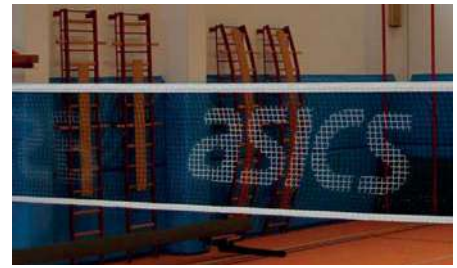

Art. P201
Rete pallavolo da gara
maglia mm. 45
a norma FIPAV
per campionati di Superlega
(personalizzabile)
 Official net for volleyball
 (customizable)



Art. P14
Coppia antenne in vetroresina divise
 Fiberglass sticks in 2 pieces

Art. P15 Coppia
 tasche porta
 antenne cm. 5
 Fixing bands for
 sticks

Art. P16
Coppia antenne in
vetroresina intere
 One piece fiberglass
 sticks



Art. S04814
Segnapunti
manuale
girevole
a 4 cifre
 4 figure
 scoreboard



Art. PP054
Segnapunti manuale
da tavolo per Pallavolo bifacciale
(numeri da 0 a 50 non divisi)
 Volleyball table scoreboard



Art. PPP30
Segnapunti scolastico per Pallavolo
(numeri da 0 a 30 non divisi)
 Volleyball school scoreboard





Art. S04804
Palchetto
arbitro pallavolo
ad altezza fissa
con scocca di
seduta,
in acciaio verniciato,
mobile su ruote
 Referee's stand fixed
 height with plastic
 seat, made of painted
 steel, on wheels

Art. 6768R
Palchetto
arbitro pallavolo
in piedi,
in acciaio verniciato,
mobile su ruote
 Referee's stand
 made of painted steel,
 on wheels



Art. S04805
Set protezioni
imbottite per palchetto
Art. S04804
 Soft protections for
 Art. S04804

(pg.39)



Art. S04816
Serie 18 Palette per
sostituzione giocatori con
contenitore
 Set of 18 substitution indicators



Art. V5409
Palchetto arbitro
pallavolo a norma
FIPAV regolabile
in altezza con
scala di accesso
e ruote per trasporto
 FIPAV Referee's chair



Art. V5419
Set protezioni
imbottite per palchetto
Art. V5409
 Soft protections for
 Art. V5409



Art. 089-V
Lavagna per pallavolo
cancellabile cm. 35x25
 Volleyball Tactical Board
 erasable 35x25 cm.



Art. V5081
Simulatore di muro su ruote in acciaio, zavorrato, con pannello a superficie irregolare
 Portable wall in painted steel with irregular surface board

pg.39



Art. V5082
Simulatore di muro portatile per squadre femminili e giovanili
 Portable wall for women and kids



Art. V5070
Ball Catcher cm. 70x70 altezza regolabile da cm. 190 a cm. 320 con anello superiore inclinabile, basamento zavorrato e retone inclusi
 Ball Catcher adjustable height and inclination (weighted base and net included)

Art. V5051
Jump Tester in acciaio zincato telescopico regolabile da cm. 230 a cm. 380 (basamento zavorrato non incluso)
 Jump Tester in galvanized steel telescopic adjustable height from 230 to 380 cm. (weighted base not included)

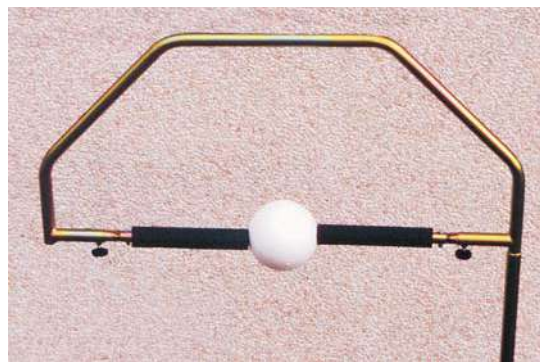
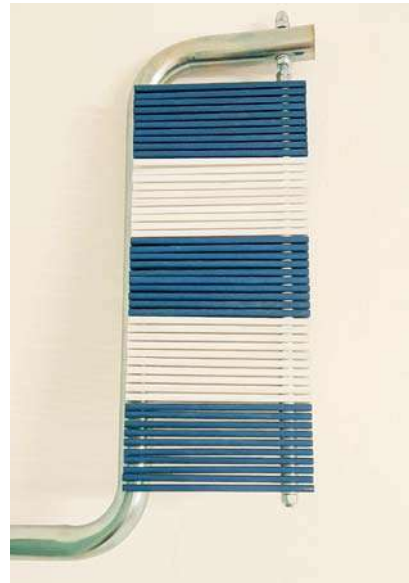

Art. V5060 Spike con ganasce (basamento zavorrato non incluso)
 Spike with jaws (weighted base not included)

Art. V5050
Basamento zavorrato multiuso per Ball Catcher, Spike, Jump Tester
 Multi-purpose weighted base





Art. BV20
Pallone Volley Trial
in gomma supersoft
 Supersoft Trial Volley ball
 (also for Hit Ball)



Utilizzabile anche
 per Hit Ball

pg.39 pg.40



Art. V20
Pallone Volley Trial
in gomma monostrato
 Single stratum Trial Volley ball



Art. ULT20-3
Pallone Volley Trial
in gomma triplo strato
 Triple stratum
 Trial Volley ball

Art. MVBS
Pallone Volley
School Mondo
Under 13
peso ridotto
 Under 13 Mondo
 Volley School ball

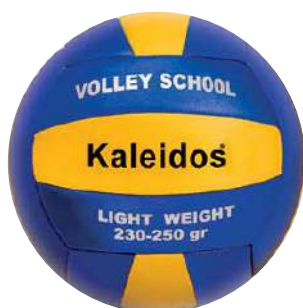

Art. 18335
Pallone Volley School Molten
V5M2501-L Under 13
peso ridotto
 Under 13 Molten
 Volley School ball



Art. VS123WL
Pallone Volley School
Mikasa VS123W-L
 Under 13 Mikasa
 Volley School ball



Art. VS123W
Pallone Volley Mikasa
VS123W allenamento
 Mikasa Volley
 training ball



Art. V300W
Pallone Volley Mikasa
V300W FIVB
approved
 Mikasa Volley match ball



Art. BT51004
Pallone Volley
regolamentare in PU
allenamento
 Official size and
 weight Volley training ball



Art. E6835
Pallone Volley
Soft Touch in PU
saldato, regolamentare
allenamento
 Official size and
 weight Volley training ball



Art. 29096
Pallone Volley Molten
Ultra Touch V5M1500
allenamento
 Molten Volley training ball



Art. 6036
Pallone Volley Molten
V5M4000
allenamento
professionale
 Pro Molten Volley
 training ball



Art. 6331
Pallone Volley gara
Molten V5M5000
"FLISTATEC" FIVB
Approved
 Molten Volley match ball



Art. USE20
Pallone Volley Trial
 gr. 405 (+50%) ø cm. 21
 allenamento potenziato
 Rubber Trial heavy Volley ball

pg.40 pg.41



Art. ULTD20
Pallone Volley Trial
 gr. 540 (+100%) ø cm. 21
 allenamento potenziato
 Rubber Trial heavy Volley ball

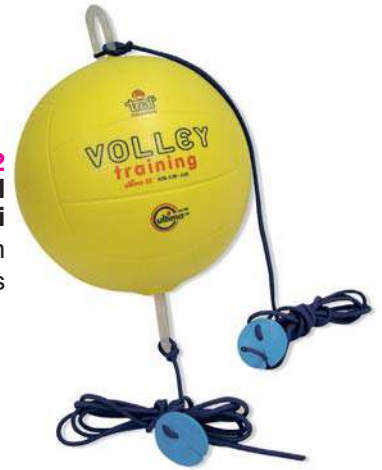

Art. ULT22
Pallone Volley Trial
 con 2 elastici
 Trial Volley ball with
 2 elastic ropes



Art. P135
Rete MINIVOLLEY su misura a richiesta
 Net for minivolley size on request

Art. P135A
Rete MINIVOLLEY con cavo in acciaio su misura a richiesta
 Net for minivolley with steel rope size on request

Art. P130
Rete MINIVOLLEY
 cm.500x70
 Net for minivolley

Art. P140
Rete SUPERMINIVOLLEY
 cm.650x100
 Net for superminivolley

**MINIVOLLEY
 SUPERMINIVOLLEY**

Art. 6780G
Impianto Minivolley
 trasportabile
 su ruote
 altezza massima
 rete cm.200
 Transportable
 Minivolley posts
 adjustable height net
 (200 cm. maximum
 height)



Art. BV15
Pallone
PRIMO VOLLEY
 Trial in gomma
 supersoft
 Trial supersoft
 Volley ball

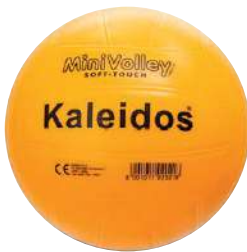

Art. 191S
Pallone MINIVOLLEY
 Mondo in gomma
 Mondo rubber Minivolley ball



Art. V33
Pallone MINIVOLLEY
 Trial in gomma
 Trial rubber Minivolley ball

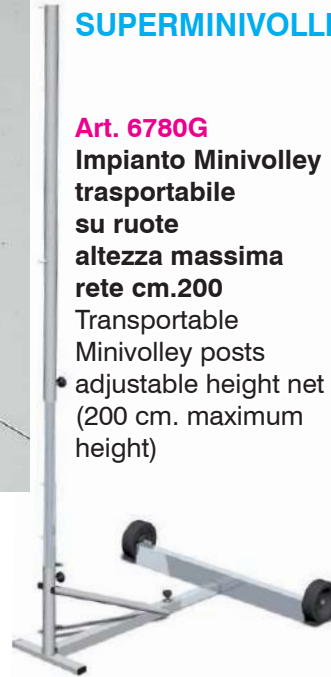

Art. ULT15-3
Pallone
PRIMO VOLLEY
 Trial in gomma
 triplo strato
 Trial triple stratum
 Volley ball

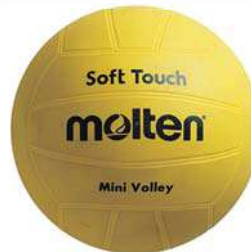

Art. 6332
Pallone MINIVOLLEY
 Molten in gomma
 Molten rubber Minivolley ball



Art. 991725/ ... /991728
Kit elastici allenamento pallavolo
 soft/medium/hard/extra hard
 Elastics for volleyball training
 soft/medium/hard/extra hard



Art. ULT26-3 / ULT27-3
**Pallone MINIVOLLEY/
 SUPERMINIVOLLEY**
 Trial in gomma triplo strato
 Trial triple stratum Minivolley/
 Superminivolley ball



Art. V27
Pallone
SUPERMINIVOLLEY
 Trial in gomma
 Trial rubber
 Superminivolley ball

BEACH VOLLEY

Art. 1051

Impianto Beach Volley regolamentare in alluminio Ø mm. 80 (rete esclusa) altezza rete regolabile anche per Beach Tennis
Beach volley posts in aluminium (net not included) adjustable height net also for Beach Tennis



pg.41



IMPIANTO = coppia pali (rete esclusa)

Art. P190

Rete Beach Volley da gara m. 8,50 con fettuccia sull'intero perimetro
Beach volley match net

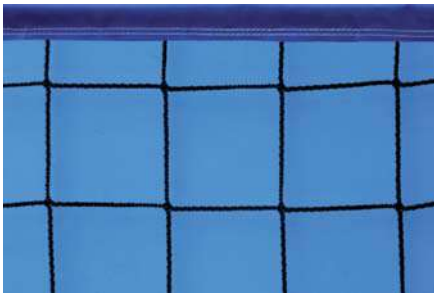

Lato A Lato B

Art. V5513

Impianto Beach Volley in alluminio Ø mm. 80 (rete esclusa) senza bussole altezza rete regolabile anche per Beach Tennis
Beach Volley posts in aluminium (net not included) with no sockets adjustable height net also for Beach Tennis



Art. P170

Rete Beach Volley m. 8,50 con fettuccia sul lato superiore
Beach volley net



Art. BVMBP
Coppia protezioni per impianto Beach Volley regolamentare altezza cm. 200 diametro cm. 8
Pair of soft protections for Beach Volley posts

Art. V5510

Impianto Beach Volley in acciaio zincato Ø mm. 70 (rete esclusa) altezza rete regolabile anche per Beach Tennis
Beach Volley posts in galvanized steel (net not included) adjustable height net also for Beach Tennis



Art. F501

Impianto Mini Beach Volley portatile con pali telescopici in ferro verniciato completo di rete m. 6,5x1 e sacca
Mini Beach Volley complete set





Art. V5543

Seggiolone per arbitro Beach Volley in acciaio ovale verniciato a polveri sez. mm.60 antinfortunistico e richiudibile in soli cm.45
Beach Volley referee's Stand

Art. V5428

Protezioni imbottite per seggiolone Art. V5543
Soft protections for Art. V5543



Art. M13719

Pallone Beach Volley Mondo BV 1000 in pelle sintetica
Mondo Beach Volley ball



pg.41

Art. P17

Kit Delimitazione campo Beach Volley
2 nastri m.16 + 2 nastri m. 8 + 8 picchetti + 8 elastici
nastri larghezza mm. 50 con occhielli alle estremità
Set for Beach Volley Bounds

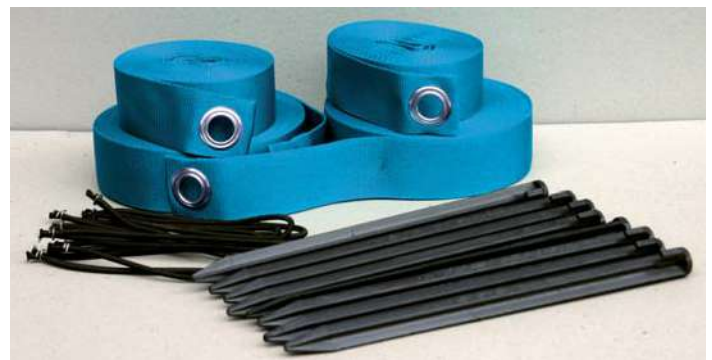

Art. P19 Kit Delimitazione regolabile per campo Beach Volley e Beach Tennis - 2 nastri m.16 + 2 nastri m.8 oppure 2 nastri m.18 + 2 nastri m.9 colore royal
Set for Beach Volley and Beach Tennis adjustable bounds color royal



pg.41

Art. 6340

Pallone Beach Volley Molten V5B5000 da gara ufficiale FIVB
Molten Beach Volley match ball



Art. 29097

Pallone Beach Volley Molten "Sweet Touch"
Molten Beach Volley ball

PROTEZIONI - Protections



Art. E6644

**Paio ginocchiere Volley trapuntate misura S, M, L
colori royal, navy, nero, rosso, fucsia, giallo fluo, verde fluo**
Pair of knee protections size S, M, L

pg.40



Art. E6645

**Paio ginocchiere Volley senza foro
posteriore con imbottitura modellata
misura JR e SR, colore royal**
Pair of knee protections for match size JR and SR



Art. 9293

**Paradenti singolo
taglia adulto**
Adult Mouthguard

Art. 9293.B

**Paradenti singolo
taglia bambino**
Junior Mouthguard

**Disponibili
anche senza
reggi-paradenti**



Art. 43602A

**Paradenti doppio
taglia S-L**
Double Mouthguard Size S-L



Art. E6641

**Paio ginocchiere Volley professionali
regolabili con velcro, misura SR colori blu e nero**
Pair of pro knee protections size SR adjustable with
velcro - colors blue and black



Art. PDFOX

**Paradenti FOX singolo
taglia adulto - vari colori**
Adult FOX mouthguard
various colors

Tagliando la porzione finale
si può ottenere
la misura bambino



Art. E6642

**Paio ginocchiere Volley gara misura JR e SR
colori rosso e bianco**
(fino ad esaurimento scorte)
Pair of knee protections for match size JR and SR
(until available)



Art. ESPN

**Maschera di
protezione per
naso, zigomi
e arcata
sopracciliare**
Face Protection
Mask



Art. E6633 Paio gomitiere Volley, misura JR e SR
colori royal, rosso e nero
Pair of elbow protections size JR and SR



Art. E6649

Art. E6650

Art. E6670

Art. E6649

Paio ginocchiere elasticizzate misura S-M-L-XL

Pair of elastic Knee Protections size S-M-L-XL

Art. E6650

Paio cosciere elasticizzate misura S-M-L-XL

Pair of elastic Thigh Protections size S-M-L-XL

Art. E6670

Paio cavigliere elasticizzate misura S-M-L-XL

Pair of elastic Ankle Protections size S-M-L-XL



Art. IS799

Ginocchiera con supporti rigidi taglia S/M - L/XL
Knee protection with metal support



Art. E784

Ginocchiera in neoprene traspirante con foro taglia S-M-L
Neoprene Knee Protection

pg.40



Art. E790

Cavigliera in neoprene taglia S-M-L

Neoprene Ankle Protection



Art. AHF-075

Polsiera stabilizzante in neoprene con foro per il pollice e chiusura regolabile con velcro

Stabilizing neoprene cuff with thumb hole and adjustable velcro closure



Art. E798

Supporto Coscia in neoprene taglia S (ad esaurimento)
Neoprene Thigh Protection (until available)

Art. ACISM

Arm compress colore nero misura S cm.37 - M cm.40 - L cm.43
Arm compress black color



Art. 90252A

Fascia sottorotulea in neoprene

Neoprene underknee band



Art. 2651A

Short in neoprene vita alta colore nero taglia S-M-L-XL
Neoprene Shorts



Art. 73001

Sospensorio con conchiglia misura S, M, L
Shell Protection size S, M, L



Art. AHF-079

Pancierina in neoprene taglia unica cm. 120x25x0,4
Neoprene stomach band 25 cm. height

IMPIANTI MULTIFUNZIONE Multi-purpose systems



Art. S05206

Impianto multifunzione professionale per volley, minivolley, tennis e salto in alto - basi zavorrate in acciaio zincato su ruote gommare, ritti centimetrati in alluminio verniciato con cursore scorrevole
 Volley, Minivolley, Tennis and High Jump transportable system - galvanized weighted bases with wheels, posts in painted aluminium with slider



Art. S05208

Coppia tabelloni basket/minibasket in plastica con canestri su supporto in acciaio per Art. S05206
 Pair of boards with baskets and steel back frames for Art. S05206



Art. S05209

Set protezioni per impianto multifunzione Art. S05206
 Soft Protection set for transportable system Art. S05206

IMPIANTO = coppia pali (rete esclusa)



pg.43



Art. S05210

Rete per impianti multifunzione Art. S05206/130FA/6780M dimensioni m. 9x1
 Net for multi-purpose systems size m. 9x1



Art. 130FA

Impianto multifunzione volley, minivolley, badminton, tennis trasportabile zavorrato con strutture verticali in acciaio verniciato metallizzato Ø mm. 80, basi in plastica riempibili da litri 105 con ruote
 Volley, minivolley, badminton, tennis transportable system with painted steel poles Ø 80 mm. 105 liter refillable plastic bases with wheels



Art. KB130

Coppia tabelloni basket/minibasket con canestri da applicare ad impianto multifunzione Art. 130FA
 Pair of boards with baskets for transportable system Art. 130FA



Art. 131F

Set protezioni imbottite sagomate per impianto multifunzione Art. 130FA
 Soft protection set for transportable system Art. 130FA



PALLAMANO - Handball

Art. 7800G
Coppia porte pallamano
in acciaio mm. 80x80
(reti escluse)
Pair of steel
handball Goals

Art. 7801G
Coppia porte pallamano
in alluminio mm. 80x80
(reti escluse)
Pair of aluminium
handball Goals

Le reti per porte
pallamano
corrispondono
alle reti
per porte calcetto
m. 3x2
Same nets as futsal
goals 3x2 m.



Art. PM113T
Coppia reti Pallamano m.3x2
annodate in nylon text Ø mm.5
con tenda ammortizzatrice
Handball nets
with shock-absorbing curtain



Art. BA25 / BA0 / BA29 / BA30
Pallone Pallamano
Trial in gomma supersoft
junior / femminile
Handball supersoft
junior / size 2 in rubber



Art. PTI.HB
Lavagna Pallamano
bifacciale, magnetica
e cancellabile cm. 35x22
Handball tactical board



**Art. V29 / V30 / V49 / V50 / ULT50-3 / ULT49-3 /
ULT30-3 / ULT303.15 / ULT29-3 / ULT24-3**
Pallone Pallamano Trial in gomma
mono e triplo strato mis. 00-0-1-1,5-2-3
Trial Handball in rubber single and triple stratum
size 00-0-1-1,5-2-3

**Special
Price**



**Art. ULT34 / ULT35 /
ULT36-3T / ULT37-3T**
Pallone Beach Handball Trial in
gomma triplo strato
mis. 00, 0, 1, 2
Trial Beach Handball in rubber size
00, 0, 1, 2

**Art. ULTS29 / ULTD29 /
ULTS30 / ULTD30 /
ULTS49 / ULTD49**
Pallone Pallamano
Trial in gomma
potenziato
Ø cm. 15/17/18,5
gr. 375/500/550/700/
630/750 (+50% / +100%)
Rubber Trial Heavier Handball



Art. SH1
Pallone Pallamano Trial Micro/Midi
Handball per l'apprendimento
dei fondamentali
Trial Rubber Micro/Midi Handball
helps in learning the basics



TABELLONI ELETTRONICI BASKET, PALLAVOLO, MULTISPORT Electronic scoreboards for basketball, volleyball, multisport



Art. F160

Tabellone portatile MULTISPORT da tavolo con tastiera di comando per BASKET, VOLLEY, CALCETTO, PALLANUOTO, PALLAMANO, KICK BOXING, PING PONG ed altro punteggi da 0 a 199 per lato set/bonus/falli da 0 a 9 per lato cronometro massimo 99 minuti e 59 secondi periodi da 0 a 9 - altezza cifre cm.9 dim. cm. 55x35x9,5
Multisport Table Scoreboard (for BASKET, VOLLEY, FUTSAL, WATER POLO, HANDBALL, KICK BOXING, TABLE TENNIS)

pg.37

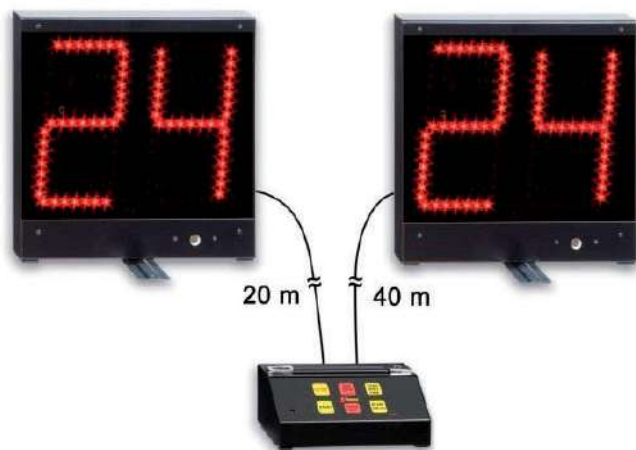

Art. F270

Kit indicatori elettronici 24 secondi h. cifre cm.20 - dim. cm.29,2x30,4x4,4 cadauno completo di console munita di tastiera visualizzazione del tempo di tiro e del timeout segnalatore acustico di fine tempo, un cavo m.20 e un cavo m.40 in dotazione
Kit 24 second indicators with console



Art. F268-02

Kit indicatori elettronici 24-30 secondi wireless h. cifre cm.20 - dim. cm.28,5x32x10 cadauno completo di console Art. F308-01 con valigetta e ricevitore radio, visualizzazione del tempo di tiro segnalatore acustico di fine tempo
Kit 24 second indicators wireless with console Art. F308-01 (with case) and radio receiver

pg.38



Art. F3045015

Tabellone segnapunti MULTISPORT dimensioni cm.91x60x9,5
peso Kg.10 - utilizzabile per BASKET, VOLLEY, CALCETTO,
PALLAMANO, PALLANUOTO, TENNIS, PING PONG, BADMINTON
altezza cifre cm.15 - visualizzazione di punteggio, cronometro, timeout, falli squadra,
periodo, possesso palla - console Art. F308-01 non inclusa, ricevitore radio incluso
Electronic Board, dim. 91x60x9,5 cm.
15 cm. high figures for various sports
console Art. F308-01 not included, radio receiver included



pg.37

Art. F308-01

Console 700 per
Art. F3045015 e Art. F3045025
Display touchscreen utilizzabile per
collegamento sia via cavo che via radio
dim. cm.24,5x17x8,5
alimentata da rete o con batteria al litio ricaricabile
Console for Art. F3045015 and Art. F3045025
with cable or radio system



Art. F3045025

Tabellone segnapunti MULTISPORT utilizzabile per
BASKET, VOLLEY, CALCETTO, TENNIS, PING PONG, PALLAMANO, PALLANUOTO, BADMINTON
altezza cifre cm.25 distanza di leggibilità m.110 - peso Kg.22 - dimensioni cm.140x83x9
da utilizzare con console Art. F308-01 (non inclusa), ricevitore radio incluso
Electronic Board, dim. 140x83x9 cm. - 25 cm. high figures for various sport
console Art. F308-01 not included, radio receiver included



Art. F242

Tabellone MULTISPORT FS-130
 dimensioni cm.200x180x9 - peso Kg.60
 costruito secondo le disposizioni FIBA
 utilizzabile per BASKET, VOLLEY, CALCETTO,
 PALLAMANO, HOCKEY, TENNIS, PALLANUOTO
 altezza cifre cm.30 tempo di gioco 99:59
 punteggi di squadra (da 0 a 199) - periodo (0 - 9)
 falli di squadra/set vinti (da 0 a 9) - bonus
 (1 punto luminoso per squadra)
 timeout (3 punti luminosi per squadra)
 possesso/servizio/turno: frecce indicatrici
 indicazione ultimo fallo avvenuto
 (numero di maglia del giocatore e numero del fallo)
 Console Art. F308-01 non inclusa, ricevitore radio
 Art. F265-20 non incluso

Electronic Board, dim. 200x180x9 cm.
 30 cm. high figures for various sport
 Console Art. F308-01 not included,
 radio receiver Art. F265-20 not included

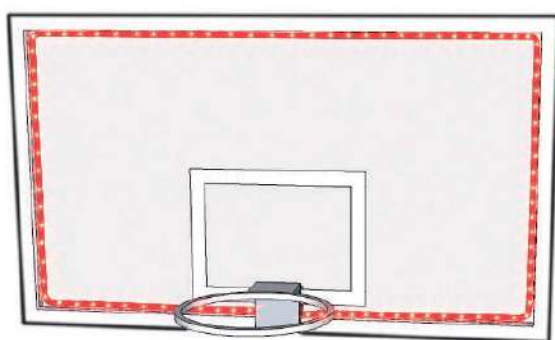

Art. F253-21

Kit cornice luminosa e centralina di comando per tabellone basket Ledstrip cm.515
 Kit light frame and control unit for basketball board Ledstrip 515 cm.



Art. F308-01

Console 700 per Art. F242
 Display touchscreen - utilizzabile per collegamento sia via cavo che via radio
 dim. cm.24,5x17x8,5
 alimentata da rete
 o con batteria al litio ricaricabile
 Console for Art. F242
 with cable or radio system

pg.38



Art. F258-51

Tabellone elettronico indicatore 24 secondi e tempo di gioco FS-24s-1
 dim. cm.70,5x60x11,5 h. cifre cm.14 e cm.30 - da collegare con
 Art. F253-21, completo di cavo m.50 per collegamento alla console
 Art. F308-01 - protetto contro gli urti della palla - *N.B. Per un impianto Basket completo occorrono n. 2 Art. F253-21 + n. 2 Art. F258-51*
 24 second indicator board



Art. F265-20

Ricevitore radio per collegamento del tabellone indicatore 24 secondi Art. F258-51 alla console Art. F308-01
N.B. Per un impianto Basket completo occorrono n. 2 Art. F253-21 + n. 2 Art. F258-51 + n. 2 Art. F265-20
 Radio receiver connecting Art. F258-51 to Art. F308-01

TENNIS

Art. 8820G
Coppia Pali Tennis in acciaio verniciato a sezione quadra con bussole da interrare e tendirete
Tennis Posts in painted steel with underground sockets

Art. 1058
Coppia Pali Tennis da fissare al pavimento in acciaio verniciato a sezione quadra e tendirete in bronzo ad arganello
Tennis Posts in painted steel for ground fixing

Art. 1056
Coppia Pali Tennis in acciaio zincato e verniciato a polvere sezione quadra con bussole da interrare e tendirete in bronzo ad arganello
Tennis Posts in galvanized and painted steel with underground sockets

Art. 1056ZA
Come Art. 1056 ma verniciato acrilico liquido
Same as Art. 1056 but painted liquid acrylic

Art. 1059
Coppia Pali Tennis da fissare al pavimento in alluminio e tendirete in bronzo ad arganello
Tennis Posts in aluminium for ground fixing

pg.42

Art. 8819G
Coppia Pali Tennis in alluminio con bussole da interrare e tendirete
Tennis Posts in aluminium with underground sockets



Art. T030
Rete Tennis annodata m.12,80x1 - sp. mm. 2,5 (centro rete non incluso)
Tennis knotted net (Art. RT1 not included)

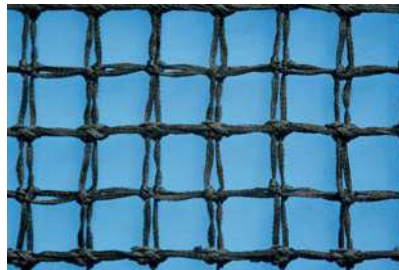

Art. T050
Rete Tennis annodata m.12,80x1 super pesante da gara - spessore mm. 3,5 (centro rete Art. RT1 non incluso)
Tennis knotted match net (Art. RT1 not included)

Art. RT1
Centro rete
Net central holder

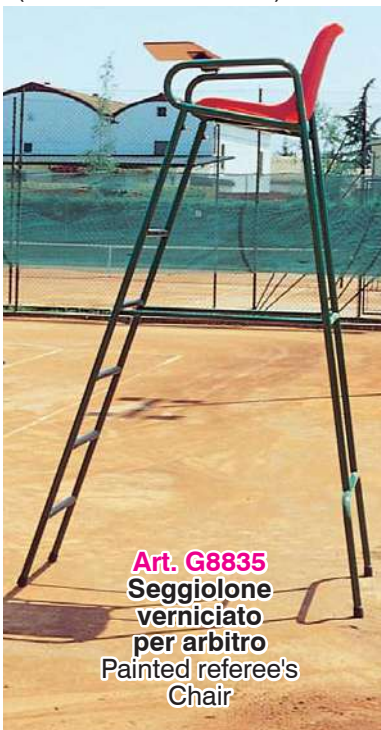

Art. G8835
Seggiolone verniciato per arbitro
Painted referee's Chair



Art. TE10030
Impianto Junior Tennis cm. 500x100 in acciaio trasportabile (rete esclusa)
Transportable junior Tennis posts in steel (net not included)

Art. TE10031
Rete per impianto
Art. TE10030
Net for Art. TE10030



Art. S04862
Impianto Tennis in acciaio zincato trasportabile (rete e zavorra escluse)
Transportable Tennis posts in galvanized steel (net and weights not included)



Art. S04868
Coppia paletti per singolo in acciaio zincato
Pair of steel poles for single



Art. RTAD / RTB912 / RTB58
Racchetta Tennis Dunlop in lega
 27" (adulti) - 25" (9/12 anni) - 23" (5/8 anni)
 Tennis rackets



Art. AGDP
Tubo 3 palle Tennis
 Dunlop
depressurizzate
 (rimbalzo ridotto
 del 50% per scuole
 tennis)
 Set 3 depressurized
 Tennis balls

pg.42

pg.43



Art. 44.045 Over Grip



Art. E6620
Paio Polsini
 tergisudore
 altezza cm. 7
 Pair of
 Wrist bands



Art. E6610
Fascia
 tergisudore
 altezza cm. 5
 Headband



Art. T4D
Tubo 4 Palle Tennis
 Head Championship
 Set 4 Tennis Balls



Art. T4DAC
Tubo 4 Palle Tennis
 Dunlop Fort All Court
 Set 4 Tennis Balls

Art. RT10
Stuoia livellatrice
 per campi in terra
 battuta m.2x1,5
 Levelling net 2x1,5 m.

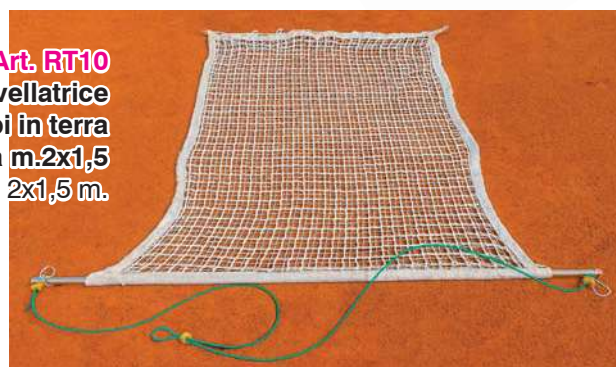

Art. 07861 Set 3 palline tennis in gommapiuma
 Set 3 foam rubber tennis balls



Art. TE220.40 **Macchina**
 lancia palline
 velocità max 130 km/h
 velocità min 32 km/h
 intervalli di lancio
 da 2 a 15 secondi
 Ball throwing machine



Art. TE51.04
Rullo in acciaio
 con racla
 Levelling roller

BEACH TENNIS - PADEL - PICKLEBALL



Art. 48018
Racchetta Beach Tennis in resina
(il colore e la grafica possono variare)
Beach Tennis racket

pg.42 pg.43



Art. PT41
Pallina Beach Tennis
Beach Tennis ball



Art. P210
Rete Beach Tennis
m.8,50x1
con fettuccia
sull'intero perimetro
Beach Tennis net



Art. T043
Rete Padel m.10x0,92
Padel net



Art. TPAPD
Tubo 3 Palle
Padel
Dunlop Team
(o modello
simile)
Set 3 Padel Balls



Art. RPDH
Racchetta Padel
KUMAR
(o modello simile)
Padel Racket



Art. P121
Rete Pickleball m.7x0,9
Pickleball net

Art. PK11002



Art. PK11002 SET 2 RACCHETTE Pickleball, 2 palline, custodia

**Art. PK12001/
PBPLI/PBPLO**



Art. PK12001 SET 6 PALLINE Pickleball indoor 26 fori - alta qualità

Art. PBPLI SET 6 PALLINE Pickleball indoor 26 fori (ad esaurimento)

Art. PBPLO SET 6 PALLINE Pickleball outdoor 40 fori

Art. PBSET SET Pickleball con rete portatile, 4 racchette, 6 palline, custodie



Art. PBSET



Art. 0934N
Rete protezione
polietilene verde annodata
maglia mm. 45x45 sp. mm. 2
Protection Net green polyethylene
mesh 45x45 mm.
knotted, thick 2 mm.



Art. 40/S - 41/S
Telo fondo campo Tennis
densità 90% o 70% mt.18x2
con banda di rinforzo
Tennis perimeter net density
90% or 70% dim. 18x2 meters



Front

Art. TE53090
Tabellone segnapunti Tennis
cm. 46x65 h. cifre cm. 8
completo di agganci
per la recinzione
Tennis scoreboard 46x65 cm.

TENNIS TAVOLO - Table Tennis

Art. BT36302
Racchetta
Ping Pong
Club 3 stelle
 3 star
 table tennis bat



Art. 568001
Racchetta Ping Pong
Dunlop Nitro
 (o modello simile)
 Dunlop table tennis bat



Art. 83925A
Racchetta
Ping Pong
Dunlop
Evolution 1000
 (o modello simile)
 Dunlop
 table tennis bat

pg.44



Art. BT35101
Confezione 6 Palline
Ping Pong 3 stelle
 Set of 6 table tennis balls
 3 stars



Art. 2C4118C
Confezione 100 Palline
1 stella colore bianco
 Set of 100 table tennis balls
 1 star



Art. 48441
Confezione 6 Palline
Dunlop Championship
1 stella
 Set of 6 table tennis balls
 1 star



Art. 17362
Confezione 3 Palline
Stiga 3 stelle Perform
 Set of 3 Stiga
 table tennis
 balls 3 stars



Art. PP50
Rete in polietilene
 Table Tennis Net



Art. E5019
Rete Ping Pong
regolabile portatile universale
 Table tennis net adjustable length

Art. 48448
Set rete con paletti
 Table Tennis Net
 with holder



Art. PPP30
Segnapunti per Ping Pong
(numeri da 0 a 30 non divisi)
 Table tennis scoreboard





Art. C-163I
Tennis tavolo
modello PROGRESS da interno
Indoor Table Tennis PROGRESS

Art. C-163E
Tennis tavolo
modello PROGRESS da esterno
Outdoor Table Tennis PROGRESS

● pg.44



Art. C-277I
Tennis tavolo
modello ADVANCE da interno
Indoor Table Tennis ADVANCE

Art. C-273E
Tennis tavolo
modello ADVANCE da esterno
Outdoor Table Tennis ADVANCE



**Tutti i tavoli sono pieghevoli
e su ruote**
All models are foldable
and on wheels



RUGBY



Art. 8836G1 / 8836G
Coppia Porte Rugby
in alluminio verniciato
m. 11 / m. 9,6 fuori terra
Rugby Goals
in painted aluminium

Art. 993156 / 993157 / 993162
Protezione imbottita per palo porta rugby
h. cm. 200, modello
quadrato oppure tondo
Soft Protection for rugby goal post, square
and round shape, height 200 cm.



Art. V71
Pallone mini-rugby Trial
in gomma monostrato
gr. 350 dim. cm.15/27
Trial rubber mini-rugby Ball
single stratum



Art. ULT71
Pallone mini-rugby Trial
in gomma doppio strato
gr. 350 dim. cm.15/27
Trial rubber mini-rugby Ball
double stratum

Art. ULT70
Pallone rugby Trial
in gomma doppio strato
gr. 450 dim. cm.19/28
Trial rubber rugby Ball
double stratum

pg.45



Art. W.MVP
Pallone football americano
in pelle sintetica
Wilson MVP ball

Art. 993164
Protezione copri bandierina
cm.10x10x100h.
Protection for rugby flag pole
10x10x100h. cm.



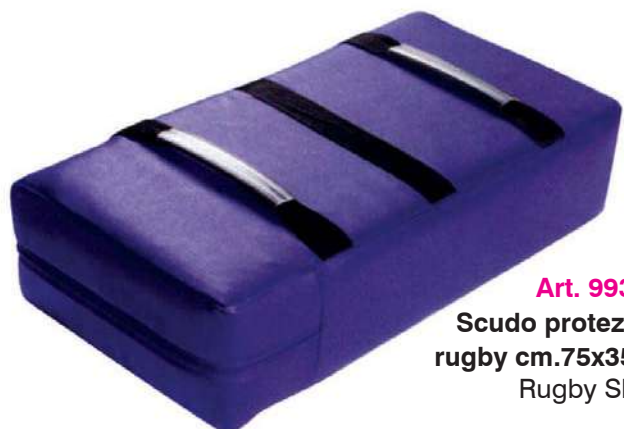

Art. 993032
Scudo protezione
rugby cm.75x35x15
Rugby Shield



Art. 6M18
Confezione 100 Tacchetti rugby
mm.18 in alluminio
Rugby aluminium studs
18 mm. 100 piece pack

pg.45



Art. 993151 / 993153JR
Sacco placcaggio rugby h. cm.140 oppure
cm.120, diametro cm. 45 oppure cm. 35,
con 3 maniglie
Sac for tackling height 140 or 120 cm.
diameter 45 or 35 cm. with 3 handles

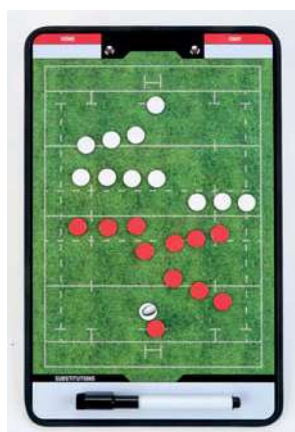

Art. PTI.RU
Lavagna Rugby bifacciale
magnetica e cancellabile
cm. 35x22 (ad esaurimento)
Rugby tactical board
35x22 cm.
(until available)

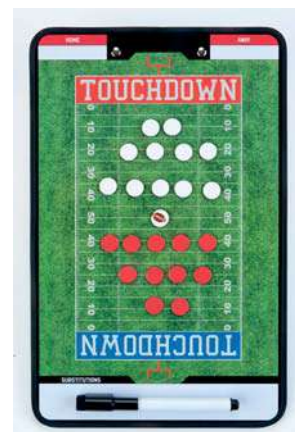

Art. PTI.FA
Lavagna Football
Americano bifacciale
magnetica e cancellabile
cm. 35x22 (ad esaurimento)
American Football
tactical board 35x22 cm.
(until available)

Art. SLZ.ST
Kit Flag Football composto da 10 cinture
regolabili con sgancio in velcro con flag
(5 gialle + 5 blu)
Flag Football kit with 10 adjustable belts
with velcrom and flags (5 yellow + 5 blue)



PISCINA - Swimming Pool



Art. E1901
Cuffia in poliester
(bicolore solo taglia adulto)
Polyester cap



Art. E1903
Cuffia in lycra plus
Lycra cap



Art. E1127
Cuffia in silicone
Silicone cap



Art. E2607
Stringinaso con
cuscinetti in silicone
Silicone nose-clip



Art. E2608
Tappi auricolari in silicone
automodellanti - Set da 4 pezzi
Silicone auricular plugs



Art. E2620
Occhialini
da piscina Junior
Junior glasses



Art. E2626
Occhialini
da piscina adulto antifog
monoscocca morbida
Senior antifog glasses



Art. E2618
Occhialini da piscina adulto antifog
monoscocca morbida
custodia con cerniera
Senior antifog glasses
case with zip



Art. E2622
Occhiale maschera
antifog monoscocca morbida
con custodia rigida
Mask glasses antifog with case

pg.44



Art. E2639
Tavoletta per piscina adulto
professionale cm.40x27
Senior professional board



Art. E2641
Ostacolatore monoblocco
cm.15x22x7,5
Swim hinder



Art. E2650
Paio palette palmari forate
cm.21x16 (misura S, M, L)
Pair of perforated palm palettes



Art. E2660
Copriscarpe in PVC
set da 2000 pezzi
misura unica
PVC shoe covers



Art. E482
Paio polsiere/cavigliere per aquagym mis. cm. 62x11x2
Water aerobics wrist/ankle supports

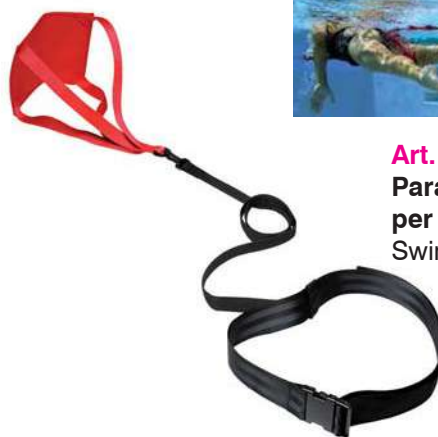

Art. E845
Paracadute per nuoto potenziato
Swimming parachute



Art. E483
Paio manubri per aquagym cm.30 - diam. cm.14
Water aerobics dumbbells

pg.44



Art. E479/3
Zattera in espanso forata dim. cm.200x100x3
Pierced mat



Art. E488
Cintura per aquagym cm.72x24x4
Water aerobics belt



Art. E2637/0
Paio manicotti arrotolabili doppia valvola (3/6 anni)
Brackets



Art. E470
Cilindro in materiale espanso per aquagym cm. 160 ø cm. 7
Water aerobics bar



Art. E480/1
Connettore per cilindro mis. cm.14 - 2 fori
Bar connector



Art. CMSAG
Step per aquagym con ventose cm.67x35x17
Water aerobics step 67x35x17 cm.

PALLANUOTO - Waterpolo

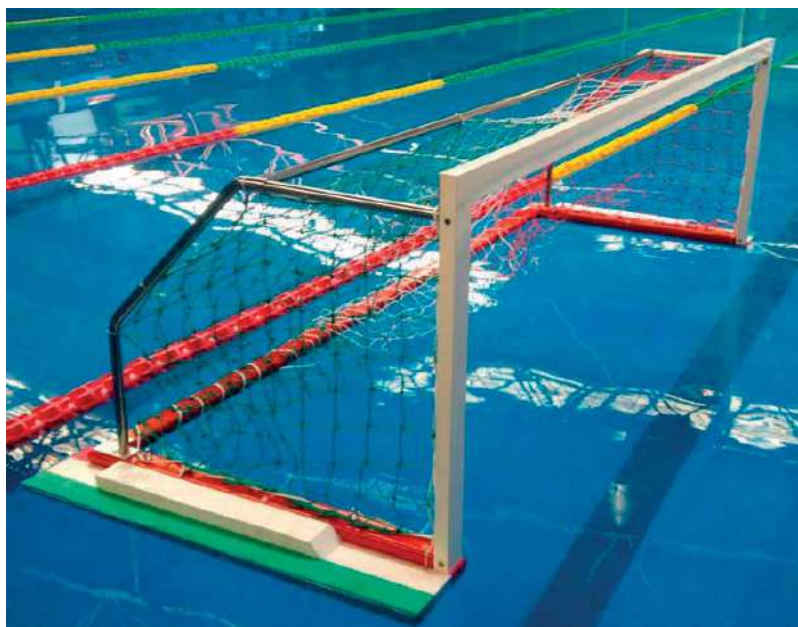

Art. PPNR

Coppia Porte da pallanuoto per partite ufficiali (reti incluse)

Pair of Waterpolo Goals for official matches (nets included)

- Realizzate a norma F.I.N.A.
- Luce interna specchio di porta m.3x0,90
- Ingombro totale m.3,50x0,975x1,25
- Specchio di porta tubolare alluminio mm.75x40x1,85 di colore bianco
- Base tubolare alluminio mm.80x40x3 colore rosso
- Accessori acciaio inox AISI 316
- Galleggianti schiuma espansa a cellule chiuse densità 350% - Peso kg.30

Art. 175P

Coppia reti per porte pallanuoto

Waterpolo Nets

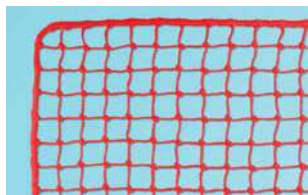

● pg.44



Art. AQPP

Coppia Miniporte da pallanuoto in PVC m. 1,5x0,8 complete di reti

Pair of Waterpolo PVC Mini-goals 1,5x0,8 m. nets included



Art. E6890

Pallone pallanuoto

Waterpolo Ball



Art. 30415

Set 13 cuffie pallanuoto con numero colore bianco o blu

Set of 13 Waterpolo caps with numbers

BADMINTON



Art. P160
Rete
Badminton
cm. 610x70
Badminton Net

Art. V7700
Impianto Badminton
professionale in acciaio verniciato
zavorrato, su ruote, con tendirete
(rete esclusa)
Pro Badminton set (net not included)



Art. BT34327
Racchetta Badminton in acciaio/alluminio
Badminton Racket in steel/aluminium

pg.45

pg.46



Art. ASTF
Racchetta Badminton Torro Fighter Club
in acciaio/alluminio
Badminton Racket Torro Fighter Club
in steel/aluminium



Art. BT33106
Confezione
6 Volani
Badminton
interamente
in plastica
Plastic
Shuttlecock
6 piece pack



Art. AS85
Confezione
6 Volani
Badminton
con capsula
in sughero
Cork tip
Shuttlecock
6 piece pack



Art. 013.SP
Impianto Mini Badminton cm. 450x170h. con rete e sacca
Mini Badminton set 4,5x1,7h. meter with net and bag

BOXE



Art. 992030
Sacco Boxe in vinile Kg.30
Vinyl boxing bag kg.30



Art. 992040
Sacco Boxe in vinile Kg.40
Vinyl boxing bag kg.40



Art. 992050
Sacco Boxe in vinile Kg.50
Vinyl boxing bag kg.50



Art. C3003S
Gancio a molla
ammortizzatore per
sacco boxe
Spring for boxing bag



Art. 993004
Supporto a muro
per sacco boxe
Iron wall support for
boxing bag



Art. 992840
Sacco Boxe basculante
h. cm. 170 zavorrato con
sacchi di sabbia (inclusi)
Self-straightening boxing bag
height 170 cm.



Art. 992804
Sacco Fit Boxe con pedana
riempibile con acqua o sabbia,
altezza regolabile (max cm. 220)
Freestanding Fit Boxing bag
adjustable height



Art. F350
Kit pera BOT-032
su supporto a muro
ripiegabile BOT-035
Pear for boxing

pg.53



Art. 42233A
Casco Boxe
misure M, L
Boxing helmet



Art. 44613A
Set protezioni
parastinco +
parapiede
misure S, M, L, XL
Shin/foot protections



Art. 17211
Coppia Fasce Boxe
Boxing bandages

pg.53



Art. 54613A
Guanti da Sacco in PU
taglie S, M, L, XL
Bag gloves



Art. 21796
Guanti Fit Boxe
taglie S, M, L, XL
Fit Boxing gloves



Art. 74613A
Guanti MMA in PU
taglie S, M, L, XL
MMA gloves

pg.53



Art. 84613A
Guanti Boxe
per combattimento
non omologati
8/10/12 oz.
Boxing gloves



Art. GN383
Guanti Boxe
Leone Thunder 10 oz.
Leone Boxing
gloves

New!

HOCKEY



pg.45

Art. S05134

Set Unihockey composto da 6+6 bastoni e 3 palline
Set Unihockey made of 6+6 sticks and 3 balls



Art. PUH01
Pallina Unihockey
Unihockey ball

Art. H1

Coppia RETI per porte da Hockey pista (indoor) in polipropilene maglia mm.45
cm.300x200x100x100
Pair of Track Hockey Goal nets

Art. H2

Coppia RETI per porte da Hockey ghiaccio in polipropilene complete di rete di sbarramento, maglia mm.20 - cm.193x122x75x120
Pair of Ice Hockey Goal nets

Art. H3

Coppia RETI per porte da Hockey prato in polipropilene complete di rete di sbarramento, maglia mm.45 - cm.366x214x90x122
Pair of Field Hockey Goal nets

Art. H4

Coppia RETI per porte da Hockey rotelle in polipropilene complete di rete di sbarramento, maglia mm.20 - cm.185x122x74x110
Pair of Roller Hockey Goal nets



Art. F806

Coppia porte Unihockey in acciaio verniciato con reti, dim. cm.150x110
Pair of Unihockey Goals in painted steel 150x110 cm.

BASEBALL



Art. TMB01
Mazza Baseball supersoft Trial
 lunghezza cm.71 diametro cm.4/5
 peso gr.460
 Supersoft Trial Baseball bat



Art. S05152
Mazza Baseball regolamentare in legno
 Wooden Baseball bat



Art. S05156
Palla Baseball rivestita in pelle sintetica
 Baseball ball



Art. S05158
Guantone Baseball in pelle sintetica
 misura senior
 Senior Baseball glove

pg.46

Art. PTI.BB
Lavagna Baseball bifacciale, magnetica e cancellabile
 cm. 35x22
 (ad esaurimento)
 Baseball tactical board
 35x22 cm.
 (until available)

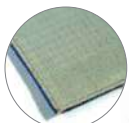

appoggio antiscivolo



imbottitura interna



Art. P21006
Set basi didattiche antiscivolo colorate
 Set of didactic anti-skid bases

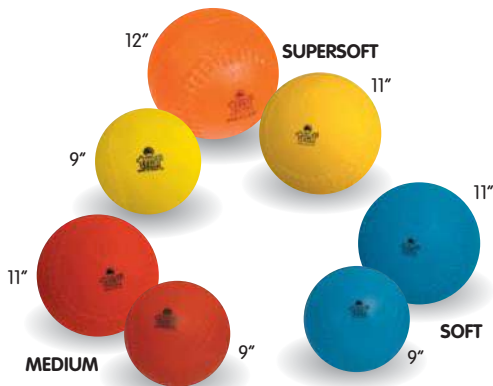

Art. BSB.8
Set 7 Palle Baseball/Softball Trial in gomma super soft
 diametri e grammature assortiti
 Set of Trial Baseball/Softball balls



Art. T21063
Batting tee Trial supersoft
 altezza regolabile da cm. 65 a cm. 86
 base diametro cm. 20,5
 peso Kg. 3
 Trial Batting tee adjustable height

MATERASSI - TAPPETI - Mats



Art. B2001/ ... /B2016

Materassi di caduta realizzati in gommapiuma di varie densità con fodera di rivestimento in PVC antimuffa, antibatterico, ignifugo Cl.2

(vedere listino per le dimensioni)

Mats of various dimensions and thickness

Materassi e fodere disponibili anche con fondo antiscivolo (dettagli sul listino prezzi)

Mats and covers also available with anti-skid bottom (details on price list)

pg.46

pg.47

pg.48

Art. B2033/ ... /B2047

Fodere di ricambio in PVC antimuffa, antibatterico, ignifugo Cl.2

(vedere listino per le dimensioni)

Spare covers for mats various dimensions

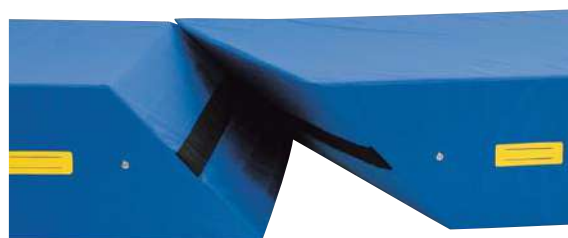

Particolare Art. B2014/ B2015/B2016

(i materassi cm.200x400 sono costituiti da due metà tagliate a 45° e tenute insieme da bande in velcro)



Art. B2214/ ... /B2219

Materassi di caduta pieghevoli (vedere listino per le dimensioni)

Foldable Mats



Più rigidi e compatti dei materassi in gommapiuma
Harder than foam rubber mats

pg.48

Art. B2228/ ... /B2231

Tappeti Gym Mat dim. cm.200x100 spessore cm.3-4-5-6 ad alta densità in polietilene a cellule chiuse per uscita attrezzi
High density Gym Mats

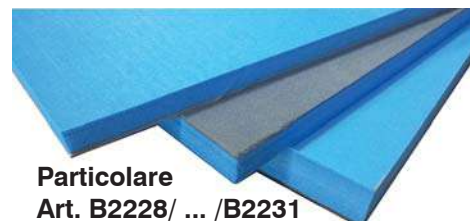

Particolare Art. B2228/ ... /B2231

Art. S00676
Carrello porta materassi
cm. 200x100
in acciaio verniciato
mobile su ruote
 Mat Trolley in painted steel size
 200x100 cm. on wheels

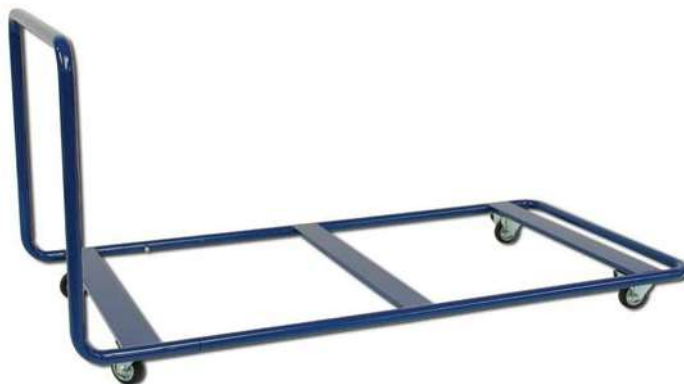

pg.47



Art. S00678
Carrello porta materassi
in verticale cm. 250x105
in acciaio verniciato
mobile su ruote
(elastici inclusi)
 Vertical mat Trolley in painted
 steel size 250x105 cm.
 on wheels
 (elastics included)



pg.48

Art. TEST.M
Tappeto Mat Test cm.100x370
con scala centimetrata da 0 a cm. 300
 Mat Test 100x370 cm.

Per allenamento tuffi portieri ed acrobazie giocatori
 For GK dive and players' acrobatic shooting training

pg.46

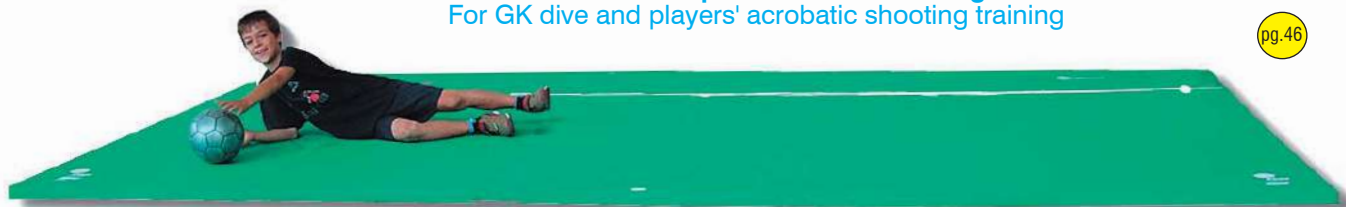

Art. BGAP13
Tappeto ammortizzante pieghevole dimensioni cm. 200x450 spessore cm. 3,5
superficie in vinile, fondo antiscivolo, imbottitura in gommapiuma densità 40 Kg/mc
 Foldable soft mat for goalkeeper and players' safe dives - size 200x450 cm. 3,5 cm. thick



ARTI MARZIALI - Martial Arts



Art. 24772
Divisa judo con cintura
misure da 00 (cm.120)
a 7 (cm.200)
Judo strip with belt

pg.53



Art. 24773
Divisa karate con cintura
misure da 00 (cm.120)
a 7 (cm.200)
Karate strip with belt



Art. 23271
Cintura judo/karate 100% cotone
colori: nero, blu, arancio, marrone,
verde, giallo, rosso
misure da 1 a 7
Judo/Karate belt



Art. 23271.B
Cintura judo/karate 100% cotone
bicolore: bianco/giallo, giallo/arancio,
arancio/verde, verde/blu,
blu/marrone - misure da 1 a 7
Bicoloured Judo/Karate belt

Art. F150
Fight Timer da parete
cm.56x19x4 - kg.1,6
Fight Timer



TATAMI

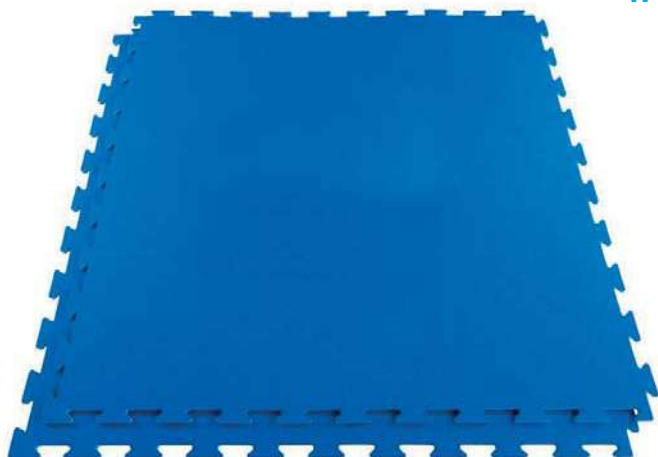

Art. R10X

TATAMI ad incastro in EVA cm.100x100x1
 colore blu con 4 bordi
 superficie lavabile, antiscivolo
 EVA Tatami soft flooring 100x100x1 cm.

pg.54

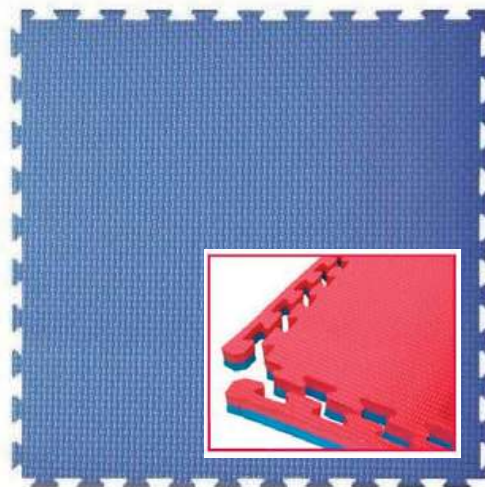

Art. MAT02 / MAT04

TATAMI ad incastro cm.100x100x2
 o cm.100x100x4 rosso/blu con 4 bordi
 superficie lavabile, antiscivolo, antifunghi,
 antibatterica, anallergica, certificato EN71
 Tatami soft flooring 100x100x2 cm./100x100x4 cm.

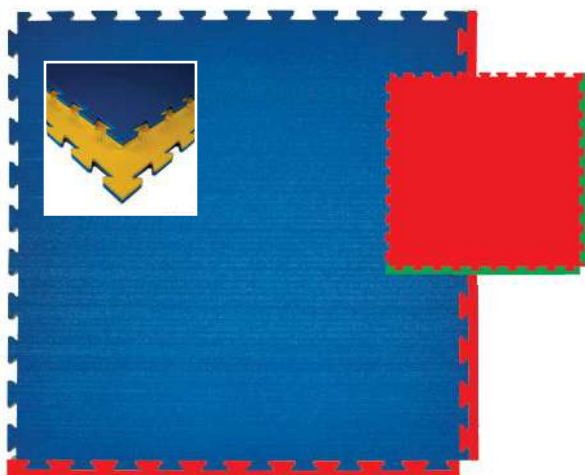

Art. TX-K20

TATAMI Karate K20
 cm. 100x100x2 ad incastro, reversibile
 in polietilene espanso reticolato
 incluso bordo protettivo perimetrale
 colori: verde/rosso, rosso/blu, giallo/blu
(ordine minimo 8 pezzi)
 TATAMI K20 100x100x2 cm.
 reversible, perimetric frame included
 colors: red/green, red/blue, yellow/blue
 (minimum order 8 pieces)

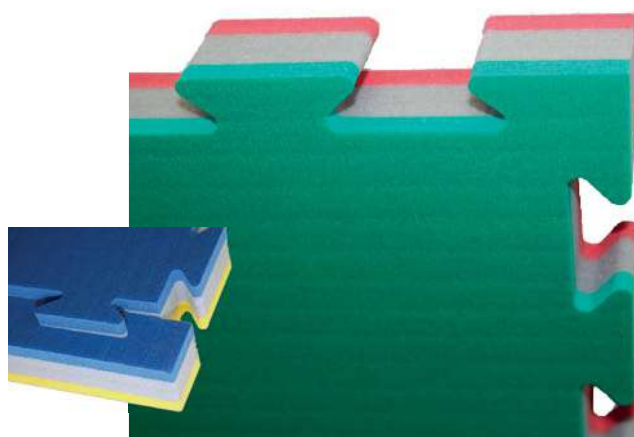

Art. TX-J40

TATAMI Judo J40
 cm. 100x100x4 ad incastro, reversibile
 in polietilene espanso reticolato
 incluso bordo protettivo perimetrale
 colori: verde/bianco/rosso, giallo/bianco/blu
(ordine minimo 4 pezzi)
 TATAMI J40 100x100x4 cm. reversible,
 perimetric frame included
 colors: red/white/green, yellow/white/blue
 (minimum order 4 pieces)



Art. TX-2010

TATAMI tradizionale
 cm. 200x100x4 in PU
 densità 230 Kg/mc
 rivestito in PVC
 con fondo antiscivolo
 colori: blu, verde, rosso, giallo
(ordine minimo 4 pezzi)
 TATAMI 200x100x4 cm.
 in PU density 230 Kg/mc
 cover with anti-skid PVC stratum
 colors: blue, green, red, yellow
 (minimum order 4 pieces)

PROTEZIONI MURARIE E PER COLONNA - Wall protections



PREVENTIVO SU RICHIESTA
PRICES ON REQUEST

Art. B2085 / B2066

Protezioni murarie e per colonna in vari spessori sagomate su misura in EVA oppure in PE ad alta densità rivestito in PVC fissaggio tramite occhiellature perimetrali, velcro oppure colla per interno ed esterno

Customized wall and column protections various thickness for indoor and outdoor



pg.46

Art. PPVCI

Protezione paraspigolo in PVC ignifugo Cl.1 lunghezza cm. 200, spessore mm. 2 larghezza cm. 3,5+3,5 in vari colori
PVC edge protection length 200 cm.
width 3,5+3,5 cm.
2 mm. thick

Si taglia facilmente alla misura desiderata e si applica rapidamente mediante normale silicone
it can be easily cut to the desired size and installed quickly with standard silicone

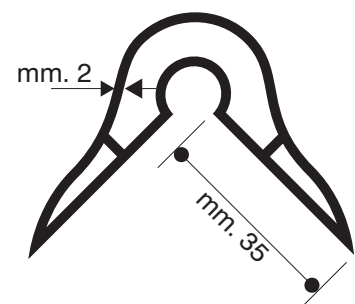

GINNASTICA - Gymnastic



Art. S00352

**Armadio porta attrezzi
a 4 ripiani in lamiera
con vano portavalori
dimensioni cm. 100x45x200h**

Equipment locker with safe-deposit box



Art. S00354

**Armadio porta attrezzi a 4 ripiani
in lamiera dimensioni cm. 100x45x200h**
Equipment locker



Art. S00356

**Armadio porta attrezzi
in lamiera dimensioni
cm. 120x45x200h
a 4 ripiani
e porte scorrevoli**
Equipment locker with
sliding doors

pg.48

Art. S00362

Mobile porta attrezzi su ruote
Equipment trolley on wheels

pg.23

Art. F406
**Armadio porta
attrezzi in acciaio
zincato a pareti
smontabili,
con ruote
dimensioni
cm. 156x76x163h**
Equipment locker in
galvanized steel
on wheels





Art. GS42/GS41/GS40/GS39 Palle Ritmiche Trial - Trial Rhythmic Balls gr. 400-350-250-150



Art. S00512
Mensola porta clavette
Club wall holder

Art. P00510/S00502/S00506
Coppia clavette in nylon,
in legno a collo lungo e collo corto
Wooden and plastic clubs



Art. E8000
Paio scarpette in pelle
per ginnastica ritmica
colore nero o bianco
taglie da 26 a 46
Pair of shoes for rhythmic gym
color black or white



Art. CS5
Corda salto
per ritmica
m. 3
Jumping rope



Art. P01210
Nastro per ginnastica
ritmica m. 6
Rhythmic
gym streamer



Art. CS7
Corda salto
per ritmica
m. 3 piombata
Weighted jumping
rope



Art. S01482
Tamburello
completo
di batacchio
Rhythmic
gym drum

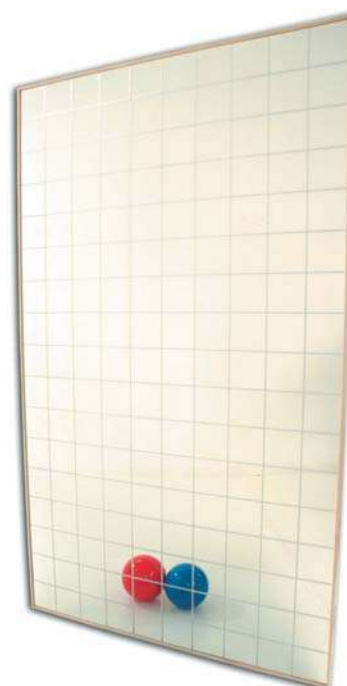

Art. S01624
Specchio quadrettato
con cornice
in legno da fissare a parete
misure cm.200x100
Wall mirror with wooden frame



Art. S01606
Supporto per sbarra regolabile da fissare a parete
 Support for bar to be fixed on the wall

pg.49



Art. S01608
Supporto per sbarra regolabile da fissare a terra
 Support for bar to be fixed on the floor



Art. S00304
Coppia ceppi Baumann in legno
 Pair of Baumann blocks in wood

pg.48



Art. S00302
Coppia appoggi Baumann in legno
 Pair of Baumann supports in wood

Art. S01602
Sbarra per danza in legno
 (pezzo unico fino a 4 metri)
 Wooden bar



Art. 1156TE
Supporto per sbarra regolabile da cm. 78 a cm. 140 in acciaio con base autoportante economica
 Cheap freestanding support for bar

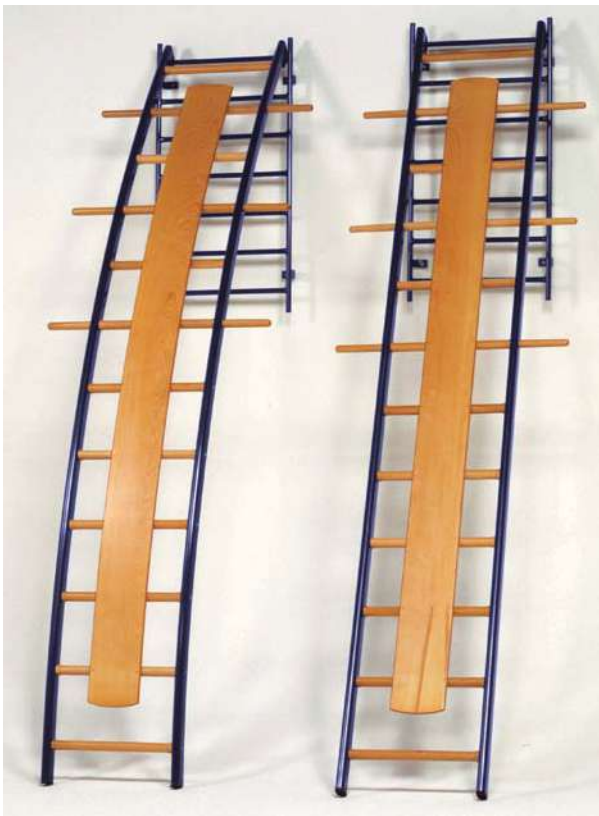

Art. S01052 / S01054 / S01060 / S01062
Scale ortopediche dritte o curve, a parete o trasportabili, lunghezza m. 3
 Orthopaedic ladders
 3 meter long



Art. S00772/S00774
Fune per salita
 lunghezza m. 5/6
 Climbing Rope
 length 5/6 m.

pg.49



Art. S00754 / S00756
Palchi di salita
 (dettagli sul listino prezzi)
 Climbing apparatus

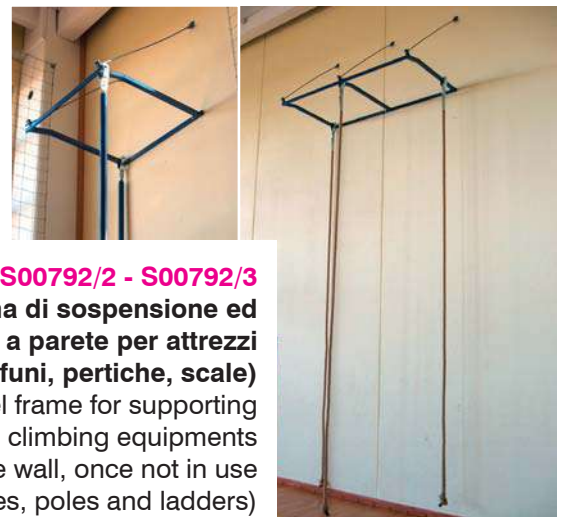

Art. S00792/2 - S00792/3
Sistema di sospensione ed accostamento a parete per attrezzi da arrampicata (funi, pertiche, scale)
 Varnished steel frame for supporting and sliding climbing equipments to the wall, once not in use (ropes, poles and ladders)



pg.48

pg.50



Art. S00060 / S00064
 Trave di equilibrio in alluminio
 rivestito lunghezza mt.5
 ad altezza regolabile
 (a norme F.I.G.)
 oppure ad altezza fissa
 Balance beam 5 meters
 adjustable height 50-120 cm.
 or fixed height

Art. S00056 / S00058 / S00052 / S00054
 Assi di equilibrio ad altezza fissa e graduabile
 Balance beams adjustable and fixed height



pg.49

Art. S00204 / S00206 / S00208 / S00210
 Pedane elastiche con piano di battuta in legno, ricoperto in gomma,
 ricoperto in moquette o a doppio molleggio
 Springboards



Art. S00104
 Cavallo regolamentare
 per volteggio
 rivestito in pelle sintetica
 altezza regolabile
 Vaulting buck
 adjustable height

pg.49



Art. V1168
 Cavallina regolamentare
 rivestita in similpelle
 altezza regolabile
 da cm. 90 a cm.130
 Vaulting buck adjustable height



pg.49

Art. S00218 / S00220
 Tappeto arrotolabile per
 pedana corpo libero
 in poliuretano e moquette,
 rotolo da m. 15/25
 larghezza cm. 100/200
 Gymnastic moquette floor,
 roll 15/25 m. long
 100/200 cm. wide



pg.14

Art. S00914/S00918/S00920
 Panche svedesi
 Swedish benches





Art. CAGL
Coppia anelli in legno di faggio con cinghie in nylon regolabili
Pair of wooden rings with adjustable nylon belts

pg.48



Art. S00002
Coppia anelli in legno lamellare
Pair of wooden rings

Art. S00018
Confezione da 8 pani magnesio gr. 55
Chalk blocks

pg.48



Art. S00252
Sbarra orizzontale per volteggi regolabile in altezza, fissaggio a terra con tiranti
Vaulting bar adjustable height

pg.49



Art. S00160
Parallela Scolastica a losanga ad altezza fissa, staggi in legno lamellare
School training parallel bars fixed height

pg.49



Art. S00156
Parallela Asimmetrica Femminile in acciaio verniciato su basamento pesante, montanti graduabili, staggi in legno lamellare regolabili in altezza e larghezza
Asymmetrical parallel bars adjustable height

Art. S00152
Parallela Maschile in acciaio verniciato su basamento pesante, montanti graduabili, staggi in legno lamellare regolabili in altezza e larghezza
Parallel bars adjustable height



ATLETICA - Track & Field

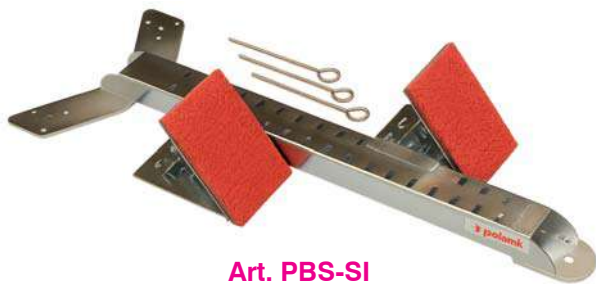

Art. PBS-SI
Blocco di partenza da allenamento
Polanik in acciaio zincato
 Starting Blocks Polanik in galvanized steel

pg.50



Art. BL01
Paio Blocchi di partenza in gomma per palestra
 Pair of gym Starting Blocks in rubber for beginners



Art. S02010/PPA38
Testimoni per staffetta
in PVC o omologati in alluminio
 PVC or aluminium relay baton

Art. TYVS
Pettorali in tyvek
per gare atletica
cm.21x16h
personalizzabili
 Numbers for competitions



Art. F601
Ostacolo per Atletica in ferro zincato
graduabile cm. 50-60-76,2
 Adjustable height
 hurdle in galvanized steel



Art. S02126
Pistola a tamburo
per starter
 Starter's revolver gun



Art. S02112
Megafono a transistor portatile
(ad esaurimento)
 Handy megaphone
 (until available)



Art. F602
Ostacolo per Atletica in ferro zincato
graduabile cm. 76,2-84-91,4
 Adjustable height
 hurdle in galvanized
 steel

pg.50

Art. PP1736A
Ostacolo per Atletica
Polanik olimpionico
da competizione
in alluminio anodizzato
omologato W.A.
 Adjustable height olympic
 hurdle in anodized aluminium
 according to W.A. standards



Art. S02064
Ostacolo per Atletica
in acciaio zincato
graduabile
cm. 76,2-84-91,4-100-106,7
 Adjustable height hurdle
 in galvanized steel



Art. 6502U
Ostacolo per Atletica
Nordicsport
olimpionico
da competizione
in acciaio/alluminio
omologato W.A.
 Adjustable height
 olympic hurdle in
 steel/aluminium
 according to W.A.
 standards



Art. S02552
Coppia ritti salto in alto scolastici altezza cm.200
Scholastic High Jump height 200 cm.



Art. S02554
Coppia ritti salto in alto scolastici in acciaio zincato altezza cm.230
Scholastic High Jump height 230 cm.



Art. S02556
Coppia ritti salto in alto in acciaio zincato periscopici h. cm.250
High Jump height 250 cm.



Art. S02558
Coppia ritti salto in alto in acciaio zincato periscopici da competizione h. cm.260
Competition High Jump height 260 cm.

(pg.52)



Art. B2080/B2081
Zone di caduta salto in alto
High Jump landing mats

Art. S02584
Piattaforma zincata di sostegno e sollevamento zona di caduta
Galvanized steel support platform for landing mats



Art. S02566
Asta segnalimite per salto in alto in PTE
High Jump crossbar with soft PTE cylinders



Art. B2077/B2078
Zone di caduta salto con l'asta
Pole vault landing mats

(pg.52)

(pg.53)



Art. S02570
Asticella segnalimite per salto in alto m. 4 in vetroresina
High Jump fiberglass crossbar



Art. VT08/ ... /VT15
Palle lancio
in gomma Trial
varie grammature
 Trial rubber throwing balls



Art. VDL5/ ... /VDL72
Palle getto anelastiche
in gomma Trial
per indoor
varie grammature
 Trial rubber shot balls
 for indoor



Art. S02486/ ... /S02496
Palle getto in metallo verniciato
tarate, varie grammature
 Metal shot balls



Art. S02510
Pedana per lancio del peso
in acciaio zincato
 Galvanized steel shot put throwing circle

pg.51

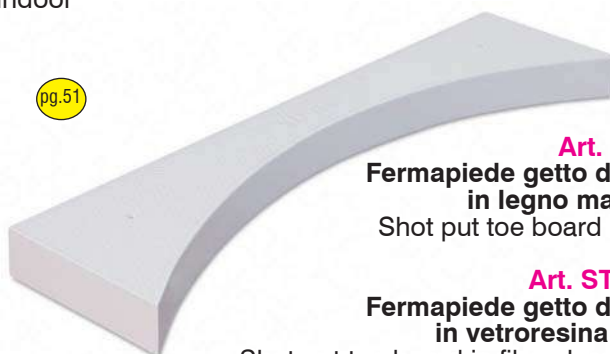

Art. S02512
FermapiEDE getto del peso
in legno massiccio
 Shot put toe board in wood

Art. STB-F100
FermapiEDE getto del peso
in vetroresina I.A.A.F.
 Shot put toe board in fiberglass I.A.A.F.



Art. CT6
Chiodo per scarpa
in acciaio mm.6 modello
Albero di Natale
(per corsa campestre)
 Shoe steel stud 6 mm.

pg.50



Art. P6 / P9 / P12
Chiodo per scarpa in acciaio
mm.6 - mm.9 - mm.12
modello Pyramid
(per pista)
 Shoe steel stud 6 - 9 - 12 mm.



Art. LM0.5/ ... /LM5
Martelli sicuri supersoft
in gomma Trial
varie grammature
 Supersoft Trial hammers

pg.52



Art. P15020
Pedana Lancio in neoprene espanso
per allenamento lancio del disco,
peso, martello e salto in lungo
 Training toe board



Art. PM2/ ... /PM10
Martelli in acciaio da allenamento Polanik
 Polanik steel hammers



Art. DSK1/ ... /DSK2
Dischi in gomma Trial varie grammature
Discus in rubber Trial

pg.50 pg.51



Art. DT0.4/ ... /DT1
Dischi Trial a 3 impugnature in gomma approvati I.A.A.F. per attività scolastica
Trial discus approved by I.A.A.F. for school training

Art. W4T/ ... /W10T
Giavellotti Polanik in lega leggera con puntale in acciaio varie grammature
Polanik Javelins in light alloy with steel edge in various weights



Art. TPD075/ ... /TPD3
Dischi in plastica bordati in acciaio Polanik
Polanik discus in plastic-steel



Art. CPD1/ ... /CPD2
Dischi in plastica bordati in acciaio Polanik - omologati I.A.A.F.
I.A.A.F. Polanik discus in plastic-steel



Art. TRTJ
Turbo Jav per avviamento al lancio
Turbo Jav for throwing introduction

Art. P15262
Junior Jav in polietilene espanso cm. 88 gr. 50
Junior Jav

Art. JAL-C400/ ... / JAL-C800
Giavellotti Vinex in lega leggera con puntale in acciaio varie grammature
Vinex Javelins in light alloy with steel edge in various weights

pg.51

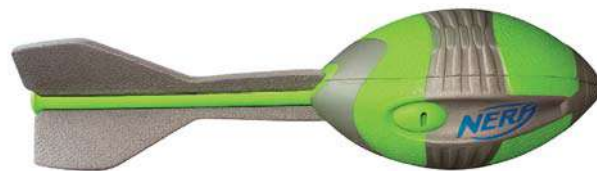

Art. VMH
Vortex per avviamento al lancio del giavellotto e per football americano
Vortex for throwing introduction



Art. VMH.J
Mini Vortex gr. 40 lunghezza cm. 17
Mini Vortex

PILATES



Art. EVA.P
Mattoncino pilates in eva
 cm.22,5x15x7,5h
 Block for pilates



Art. MPS30
Mattoncino pilates gonfiabile
 Trial soft gr. 300 cm.12x24x3,5h
 Inflatable block for pilates

pg.54



Art. AHF-065/AHF-066
Sfera tonificante
 verde kg.1 / viola kg.1,5
 Toning balls

Art. AHF-045
Palla per yoga
 ø cm.25
 Yoga ball



Art. BA4
Palla tender per pilates
 ø cm.20 - gr. 180
 super soffice e sicura
 Trial rubber tender ball
 for pilates



Art. TR38
Toning ring
 Toning ring



Art. AHF-001
Coppia sfere per massaggi
 verde ø cm.7,5
 viola ø cm.9
 Massage balls

pg.21



Art. B55 / B75
Relax Ball Trial
 ø cm.5,5 / 7,5
 Relax Ball



Art. AHF-020
Power grip ball
 Power grip ball



Art. 995025
Cilindro pieno
Foam roll
 lunghezza cm. 90
 ø cm.15
 Foam roll not
 inflatable

Art. FY9512
Fitball roller
 gonfiabile
 ø cm.18
 Fitball roller inflatable



Art. 995025BIS
Mezzo cilindro
pieno Foam roll
 lunghezza cm. 90
 altezza cm.7,5
 Half Foam roll
 not inflatable

pg.54



Art. AHF-044
Rullo massaggio
 lunghezza cm.33
 ø cm.14
 Massaging roll



Art. AHF-111
Rullo massaggio
 con impugnature
 cm.53 ø cm.4,5
 Massaging roll



pg.23



Art. TBSA/TBSB
Palla Boa autobilanciante in gomma
 Trial oscilla ma torna al suo posto senza rotolare,
 stabile, ideale per correggere la postura,
 monocolore per adulti/bicolore per bambini
 Trial rubber Boa Ball swings but comes back
 to its original position - very good for postural
 therapy for adults and children

PALLAPUGNO - BOCCE - TAMBURELLI



pg.55

Art. ST14

Palla Canguro Ø cm. 45
Trial Cangaroo Ball



Art. ST15

Palla Canguro Ø cm. 55
Trial Cangaroo Ball



Art. ST16

Palla Canguro Ø cm. 65
Trial Cangaroo Ball



Art. BA1

Air Ball Trial Ø cm. 12 gr. 100
morbida e rimbalzante
(ideale anche per pallapugno)
Trial Air Ball



pg.54

Art. M05010

Pallapugno FIPAP
Ø cm. 14 gr. 65
FIPAP pallapugno



Art. ASKB

Set 8 bocce in
legno laccato Ø mm. 100
con pallino Ø mm. 40
Set 8 wooden bowls

pg.55

Art. BTST12

Set 6+6 bocce supersoft
con pallino e borsa
Set of 12 supersoft
bowls with bag



Art. P18110

Tamburello indoor
Ø cm. 26
(fino a 13 anni)
omologato FIPT
FIPT indoor
tamburello Ø cm. 26



pg.54

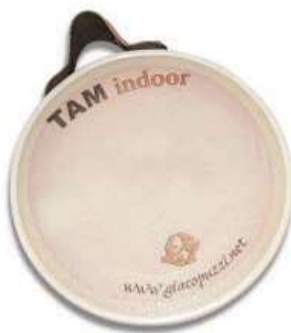

Art. P18111

Tamburello indoor
Ø cm. 28
omologato FIPT
FIPT indoor tamburello
Ø cm. 28



pg.55

Art. S00552 / S00556
Fune per tiro alla fune
lunghezza m. 15 / m. 25
con indicazioni colorate
Rope for tug of war
length 15 m. / 25 m.



Art. PT41

Pallina per tamburello
depressurizzata
indoor Ø cm. 6,5 gr. 40
Tamburello indoor
depressurized ball



Art. I-059
Set 10 mattoncini dritti
cm. 25x16x13h
Set of 10 straight bricks



Art. I-060
Set 10 mattoncini curvi
cm. 22x16x13h
Set of 10 curved bricks



Art. I-098
Blocco percorso
cm. 30x15x10h
Block for route

pg.55



Art. I-061
Percorso equilibrio composto da 5 assi + 6 mattoncini + 24 ventose
Balance route



**PALLA
AVVELENATA
Dodgeball**



pg.54

**Special
Price**



Art. TDB16
Palla per Dodgeball diametro cm. 16
peso gr. 230 colore arancio fluo
Dodgeball Ø 16 cm.

Art. TDB20
Palla per Dodgeball diametro cm. 20
peso gr. 250 colore giallo fluo
Dodgeball Ø 20 cm.

SKATEBOARD - PATTINI - MONOPATTINI - FRISBEE



Art. SKM2401 Skateboard Junior cm. 61
Junior Skateboard 61 cm.



Art. SKM3103 Skateboard Senior cm. 77,5
Skateboard 77,5 cm.

Ad esaurimento
Until available



pg.54

Art. GDA20
Bersaglio elettronico per il gioco delle freccette (incluse 6 freccette e 40 punte di ricambio)
Darts electronic target (including 6 darts and 40 spare tips)



Art. 681171
Set 3 protezioni Junior
Junior protections

Ad esaurimento
Until available



Art. SKJP-G
Pattino in line allungabile Junior
taglie: 30/33 - 34/37 - 38/41
In line skate adjustable size



Ad esaurimento
Until available



pg.54

Art. ML9200
Monopattino pieghevole, ruote Ø mm. 200 peso massimo utilizzatore kg. 100
Scooter



Art. ML8125
Monopattino pieghevole, ruote Ø mm. 125 peso massimo utilizzatore kg. 50
Junior Scooter

Ad esaurimento
Until available

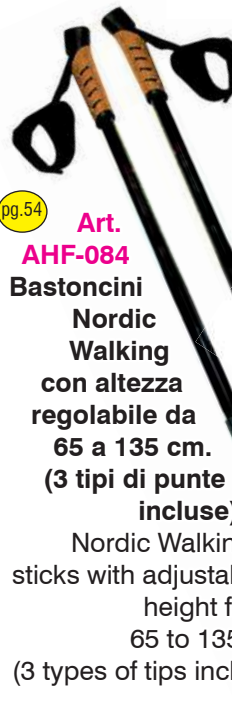

pg.54

Art. AHF-084
Bastoncini Nordic Walking con altezza regolabile da 65 a 135 cm. (3 tipi di punte incluse)
Nordic Walking sticks with adjustable height from 65 to 135 cm. (3 types of tips included)



Art. FRPPR
Frisbee Ø cm. 27 gr. 110
Frisbee

INDICE ALFABETICO

Archi di precisione - Precision Arcs	pag.	48
Arredi spogliatoio ed infermeria - Locker and infirmary room	pag.	168-173
Arti marziali, Boxe - Boxing, Martial Arts	pag.	218-219;212
Atletica - Track and Field	pag.	226-229
Attrezzi speciali, Scalette e Bande elastiche - Special Training tools, Speed Ladders and Elastic Bands	pag.	71-87
Badminton	pag.	211
Bandierine e accessori per arbitro - Flags and referee's accessories.....	pag.	116-119
Barriera filtrante, Barriera con finestre - Reflex Training Device, Window Barrier.....	pag.	49
Basket	pag.	177-184
Beach Soccer	pag.	175
Beach Volley	pag.	192-193
Borse - Bags	pag.	134-135
Casacche, Pantaloncini, Calze - Mesh shirts, Shorts, Socks	pag.	98-99
Contenitori Portapalloni - Baskets for balls.....	pag.	136
Cross Training, Reti per calci di precisione - Cross Training, Precision shooting nets.....	pag.	152-153
Delimitatori e Birilli - Markers and Cones	pag.	29-33
Deviatori di traiettoria, Ball Playning - Deviators, Ball Playning	pag.	60-62
Fitness Equipment.....	pag.	89-97
Forche - Heading Trellises	pag.	46-47
Ghiaccio, Tape, Creme, Oli - Ice, Tape, Creams, Oils.....	pag.	112-113
Ginnastica - Gymnastic	pag.	221-225
Hockey, Baseball	pag.	214-215
Impianti Multifunzione - Multi purpose systems	pag.	196
Kit Calcio Tennis - Soccer Tennis kits.....	pag.	43-45
Kit tecnico Scuola Calcio - Soccer School kit.....	pag.	88
Lavagne Tattiche - Tactical Boards.....	pag.	108-111
Materassi, Protezioni Murarie - Mats, Wall Protections.....	pag.	216-217;220
Materassini, Borracce - Mats, Water Bottles	pag.	124;114-115
Minivolley, Superminivolley	pag.	191
Muri e Telai con rete - Rebounders and Iron Frames with net	pag.	50-59
Numeri Termosaldabili - Numbers for uniforms	pag.	107
Ostacoli ad altezza fissa e regolabile - Hurdles fixed and adjustable heights.....	pag.	28;33-42
Paletti Slalom - Slalom Poles.....	pag.	23-26
Pallamano - Handball	pag.	197
Palle Mediche, Ritmiche e Psicomotorie - Medicine, Rhythmic and Gym Balls.....	pag.	129-133
Palloni in pelle ed in gomma - Leather and rubber Balls	pag.	125-128
Panchine Allenatori - Trainers' Dugouts	pag.	155-161
Parastinchi, Fasce Capitano, Guanti Portiere - Shinguards, Captain Armbands, GK Gloves	pag.	104-105
Pilates, Didattica Scolastica, Pattini e Skateboard - Pilates, School Products, Skates	pag.	230-233
Piscina, Pallanuoto - Swimming Pool, Waterpolo	pag.	208-210
Pompe, Compressore, Cronometro e Rotelle Metriche - Pumps, Inflator, Chronometer, Measuring Tapes	pag.	120-121
Porte regolamentari, ridotte, miniporte, porte bifrontali - Official goals, reduced goals, minigoals, 2 side goals .pag.	pag.	137-147
Protezioni - Protections.....	pag.	194-195
Reti di Protezione - Protection Nets.....	pag.	154
Reti regolamentari e ridotte - Nets all sizes.....	pag.	148-151
Rugby	pag.	206-207
Sagome e Barriere - Mannequins and Barriers.....	pag.	10-22
Sedute per gradinate e Tribune modulari per interno ed esterno - Stadium seats and Stands	pag.	165-167
Segnalatori manuali ed elettronici per cambio giocatori - Substitution Boards	pag.	122-123
Strutture instabili e Tavolette Propriocettive, Plinti - Equilibrium Boards.....	pag.	63-69
Tabelloni elettronici segnapunti - Electronic scoreboards.....	pag.	198-200
Tacchetti ed accessori per scarpe, Lavascarpe - Studs and shoe accessories, Shoe Washing Device.....	pag.	100-103
Tavoli calcetto - Soccer tables	pag.	176
Tennis Tavolo - Table Tennis	pag.	204-205
Tennis, Beach Tennis, Padel, Pickleball	pag.	201-203
Trampolini - Trampolines	pag.	70
Tunnel uscita spogliatoi - Stadium Tunnels.....	pag.	174
Vernice Segnacampo, Carrelli traccialinee - Ecological Paint, Line Markers.....	pag.	162-164
Volley	pag.	185-191

NEW VIDEOS ON
WWW.BARRETSport.COM



BARRET®

ATTREZZATURE PER L'ALLENAMENTO DEI CAMPIONI
TRAINING TOOLS FOR CHAMPIONS



BARRET SRL

Via Marie Curie, 6/8
Zona Ind.le S. Pietro in Palazzi
57023 Cecina (LI) - Italy
tel. (+39) 0586 661215
fax (+39) 0586 662417
info@barretsport.com
www.barretsport.com

